

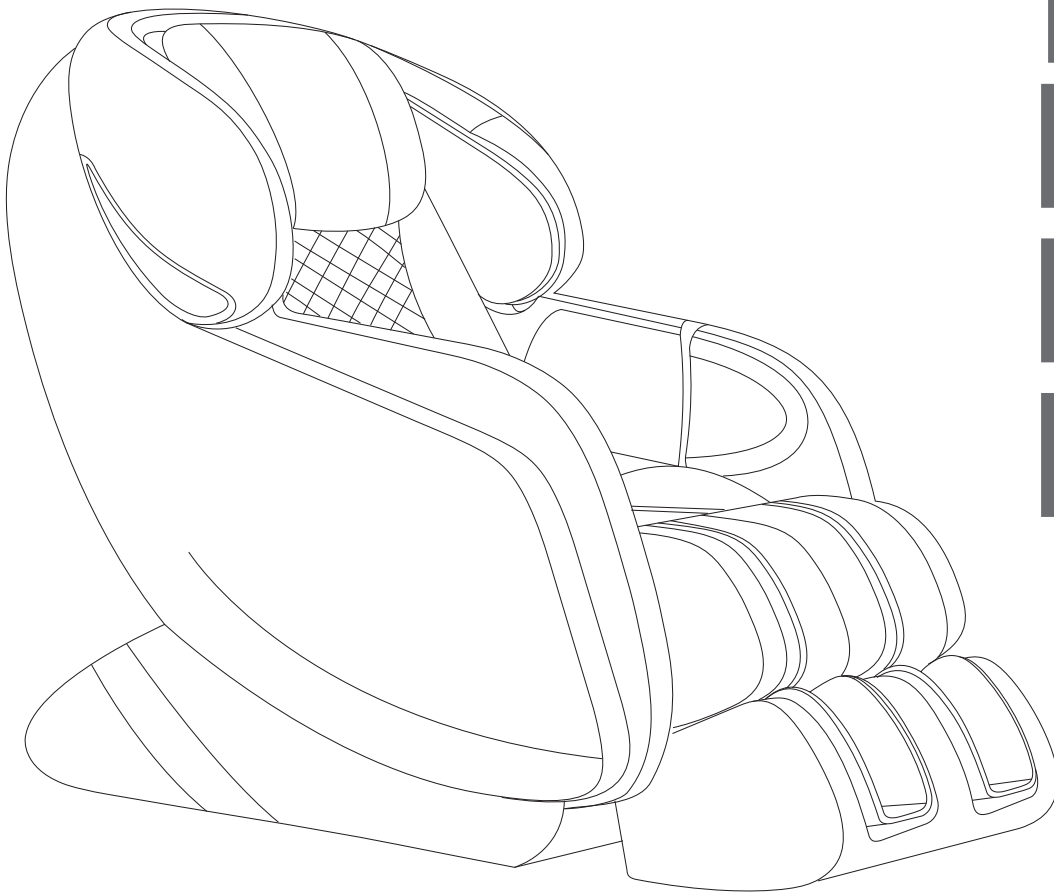

TAURUS WELLNESS

Assembly and Operating Instructions



max. 205 cm



max. 160 kg



~ 20 Min.



73 kg

L 138 | W 78 | H 115

SKU: FAMA5505

FSUKFAMA5505.01.02



Content

1	GENERAL INFORMATION	8
1.1	Technical Data	8
1.2	Personal Safety	9
1.3	Electrical Safety	10
1.4	Set-Up Place	11
2	ASSEMBLY	12
2.1	General Instructions	12
2.2	Scope of Delivery	12
2.3	Assembly	13
2.4	Overview	14
2.5	Adjusting to Body Height	15
3	OPERATING INSTRUCTIONS	16
3.1	Button and Function Description	16
3.2	Programmes	20
3.2.1	Automatic Programmes	20
3.2.2	Manual Programmes	21
3.3	Wireless Connection	21
4	STORAGE AND TRANSPORT	22
4.1	General Instructions	22
4.2	Transportation Wheels	22
5	TROUBLESHOOTING, CARE AND MAINTENANCE	23
5.1	General Instructions	23
5.2	Faults and Fault Diagnosis	23
5.3	Error Codes and Troubleshooting	24
5.4	Maintenance and Inspection Calendar	24
6	DISPOSAL	24
7	ORDERING SPARE PARTS	25
7.1	Serial Number and Model Name	25
8	WARRANTY	26
9	CONTACT	28





Dear customer,

Thank you for choosing a Taurus wellness device. With the Taurus Wellness Line, we offer you relaxation, regeneration and massage for your home. In this way, the Taurus Wellness Line can contribute to greater health and well-being. We wish you a relaxing time. If you have any questions about these or other devices of the Taurus brand, please feel free to contact us.

Your team from Taurus Wellness and the Fitshop Group.

Intended Use

The equipment may only be used for its intended purpose.

The equipment is only suitable for home use. The equipment is not suitable for semi-professional (e.g. hospitals, associations, hotels, schools, etc.) and commercial or professional use (e.g. fitness studios).

Legal Notice

Fitshop GmbH
Europe's No. 1 for home fitness

International Headquarters
Flensburger Straße 55
24837 Schleswig
Germany

Management:
Christian Grau
Sebastian Campmann
Dr. Bernhard Schenkel
No. HRB 1000 SL
Local Court Flensburg
European VAT Number: DE813211547

Disclaimer

© Taurus Wellness is a registered brand of the company Fitshop GmbH. All rights reserved. Any use of this trademark without the explicit written permission of Fitshop is prohibited.

Product and manual are subject to change. Technical data can be changed without advance notice.

FITSHOP

Europe's No.1 for Home Fitness



ABOUT THIS MANUAL

Please carefully read the entire manual before installation and first use. The manual will help you to quickly set up the system and explains how to safely use it. Make sure that all persons exercising with the equipment (especially children and persons with physical, sensory, mental or motor disabilities) are informed about this manual and its contents in advance. In case of doubt, responsible persons must supervise the use of the equipment.

Due to ongoing changes and software optimisations, the manual may have to be updated. If you notice any discrepancies during assembly or use, please refer to the manual uploaded to the webshop. The latest manual is always available there.



This equipment has been manufactured according to the latest safety knowledge. As far as possible, potential safety hazards which could cause injury have been eliminated. Make sure to carefully follow the instructions and that all parts are securely in place. If required, read through the instructions again to correct any mistakes.

Training devices must be classified according to accuracy and use. Accuracy classes are only applicable to devices that display training data.

Accuracy classes

Class A: high accuracy.

Class B: medium accuracy.

Class C: low accuracy.

The use classes explain the intended use of the training device.

Use classes

Class S (studio): professional and/or commercial use.

These training devices are intended for the use in training rooms of facilities such as sports clubs, school facilities, hotels, clubs and studios whose access and supervision is specifically regulated by the owner (person with legal responsibility).

Class H (home use): use at home.

These stationary training devices are intended for the use in private homes where access to the training device is regulated by the owner (person with legal responsibility).



Please pay close attention to the safety and maintenance instructions given here. The contract partner cannot be held liable for damage to health, accidents or damage to the equipment when it is not used in accordance with these instructions.

The following safety instructions may appear in this manual:

► **ATTENTION**

This notice indicates potentially hazardous situations which, if not avoided, may result in property damage.

⚠ **CAUTION**

This notice indicates potentially hazardous situations which, if not avoided, may result in slight or minor injuries!

⚠ **WARNING**

This notice indicates potentially hazardous situations which, if not avoided, may result in death or serious injuries!

⚠ **DANGER**

This notice indicates potentially hazardous situations which, if not avoided, will result in death or serious injuries!

ⓘ **NOTICE**

This notice indicates further useful information.

Retain these instructions in a safe place for future reference, maintenance or when ordering replacement parts.



1.1 Technical Data

Display of:

- + Timer in min.
- + Massage strength
- + Air pressure intensity
- + Massage speed
- + Width
- + Heat function
- + Automatic or manual programme
- + Massage zones

Programmes in total:	10
Manual programmes:	5
Automatic programmes:	4

Automatic timer: 15 Minutes

Power input:	220 V, 50 Hz
Power consumption:	150 W
Amount of motors:	3

Weight and dimensions

Package dimensions (L x W x H) approx.:	169 cm x 80 cm x 93 cm
Set-up dimension (L x W x H) approx.:	138 cm x 78 cm x 115 cm
Reclined dimensions (L x W x H) approx.:	166 cm x 78 cm x 93 cm

Article weight (gross, incl. packaging) approx.:	80 kg
Article weight (net, excl. packaging) approx.:	73 kg

Maximum user weight:	160 kg
Maximum body height:	205 +/- 5 cm depending on body structure

Use class: H



1.2 Personal Safety

DANGER

- + Before you start using the equipment, you should consult your physician that this type of exercise is suitable for you from a health perspective. Particularly affected are persons who: have a hereditary disposition to high blood pressure or heart disease, are over the age of 45, smoke, have high cholesterol values, are overweight and/or have not exercised regularly in the past year. If you are under medical treatment that affects your heart rate, medical advice is absolutely essential.
- + Note that excessive training can seriously endanger your health. Please also note that heart rate monitoring systems can be inaccurate. If you notice any signs of weakness, nausea, dizziness, pain, shortness of breath, or other abnormal symptoms, stop exercising immediately and seek advice from your doctor if necessary.

WARNING

- + This equipment may not be used by children under the age of 14.
- + Children should not be allowed unsupervised access to the equipment.
- + Persons with disabilities must have a medical license and must be under strict observation when using the equipment.
- + The equipment is strictly for use by one person at a time.
- + The owner must communicate all warnings and instructions to the user.
- + If your equipment provides a safety key, the clip of the safety key must be attached to your clothing before starting your training. In the event of a fall, the EMERGENCY STOP of the equipment can be initiated.
- + Keep your hands, feet and other body parts, hair, clothing, jewellery and other objects well clear of moving parts.
- + During use, wear suitable sports clothing rather than loose or baggy clothing. When wearing sports shoes, make sure they have suitable soles, preferably made of rubber or other non-slip materials. Shoes with heels, leather soles, studs or spikes are unsuitable. Never exercise barefoot.

CAUTION

- + If your equipment needs to be connected to the power supply with a mains cable, make sure that the cable is not a potential tripping hazard.
- + Make sure that nobody is within the range of motion of the equipment during training so as not to endanger you or other persons.

ATTENTION

- + Do not insert any objects of any kind into the openings of the device.



1.3 Electrical Safety

DANGER

- + In order to reduce the risk of an electric shock, always unplug the equipment from the mains socket immediately after your workout, before assembly or dismantling, and before maintenance or cleaning. Do not pull on the cable.

WARNING

- + Do not leave the equipment unattended while the mains cable is plugged into the mains socket. During your absence, the mains cable must be removed from the mains socket to prevent improper use by third parties or children.
- + If the mains cable or plug is damaged or defective, contact your contract partner. Until repair, the equipment must not be used.

ATTENTION

- + The equipment requires a mains connection of 220-230 V with 50 Hz mains voltage.
- + The equipment may only be connected directly to an earthed socket using the supplied mains cable. Extension cables must conform to VDE guidelines. Always completely unwind the mains cable.
- + The socket must be protected by a fuse with a minimum fuse rating of "16 A, slow blow".
- + Do not make any changes to the mains cable or the mains plug.
- + Keep the mains cable away from water, heat, oil and sharp edges. Do not route the mains cable underneath the equipment or under a carpet or rug, and do not place any objects on top of it.



1.4 Set-Up Place

WARNING

- + Do not place the equipment in main corridors or escape routes.
- + To avoid fires, do not place the appliance near or in rooms with high heat (e.g. near a heater).

CAUTION

- + Choose the place in which to set up the equipment such that there is enough free space/ clearance to the front, the rear and to the sides of the equipment.
- + The set-up and mounting surface of the equipment should be flat, loadable and solid.

ATTENTION

- + The device may only be used in one building, in sufficiently tempered and dry rooms (ambient temperatures between 10°C and 35°C). The equipment should not be used outdoors or in rooms with high humidity (over 70%) like swimming pools.
- + A floor protective mat/equipment underlay can help to protect high-quality floor coverings (parquet, laminate, cork, carpets) from dents and sweat and can help to level out slight unevenness.
- + To prevent the cover from fading or wearing out more quickly, do not place the unit in locations exposed to direct sunlight and/or high heat.



2.1 General Instructions

DANGER

- + Do not leave any tools, packaging materials such as foils or small parts lying around, as otherwise there is a danger of suffocation for children. Keep children away from the equipment during assembly.

WARNING

- + Pay attention to the instructions attached to the equipment in order to reduce the risk of injuries.

CAUTION

- + Ensure to have sufficient room for movement in each direction during assembly.
- + The assembly of the equipment must be carried out by at least two adults. If in doubt, seek the help of a third technically skilled person.

ATTENTION

- + To prevent damage to the equipment and the floor, assemble the equipment on a mat or packaging board.

NOTICE

- + Ideally, assemble the equipment at its later set-up place.

2.2 Scope of Delivery

The scope of delivery consist of the following parts. At the beginning, check whether all parts and tools belonging to the device are included in the scope of delivery and whether damage has occurred. In the event of complaints, the contractual partner must be contacted directly.

CAUTION

- If parts of the scope of delivery are missing or damaged, the assembly must not be carried out.

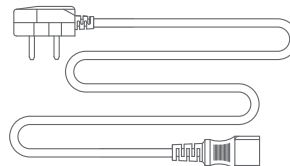
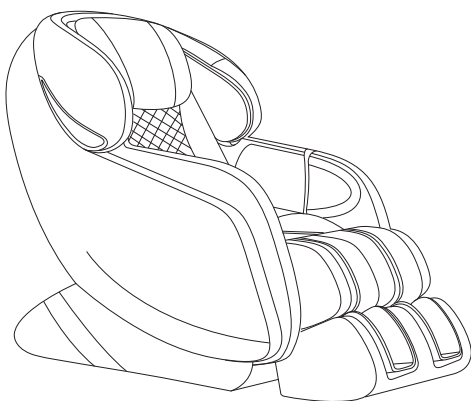

2.3 Assembly

Before assembly, take a close look at the individual assembly steps shown and carry out the assembly in the order given.

① NOTICE

- + First loosely screw all parts together and check that they fit properly. Tighten the screws using the tool only when you are instructed to do so.
- + If you have difficulty recognising the graphics, we recommend that you open and/or download the PDF instructions stored in the webshop on your end device (e.g. smartphone, tablet or PC). There you have the option of zooming in closer. Please note that the Adobe Acrobat Reader programme must be installed on your end device in order to open the file.

1. Carefully remove the upper carton cover from the product.
2. Place the cover for the backrest and the pillow on the product.
3. Fold down the sides of the bottom carton.
4. Move the product to the desired position using the transportation wheels. Please take notice of the instructions given in section 1.4 and chapter 4.
5. Plug the power plug into a wall outlet that complies with the instructions in the chapter on electrical safety.

▶ ATTENTION

- + The equipment must not be connected to a multiple socket, otherwise it cannot be guaranteed that the equipment will be supplied with sufficient power. Technical errors can result.
- + Make sure that the power cord is not pinched under the product to prevent damage to the power cord.

6. Set the power switch on the back of the massage chair to "I" to switch on the massage chair.

▶ ATTENTION

Make sure that you switch off the massage chair via the control panel and set the power switch to "O" after each use.

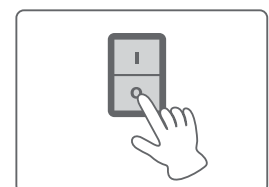
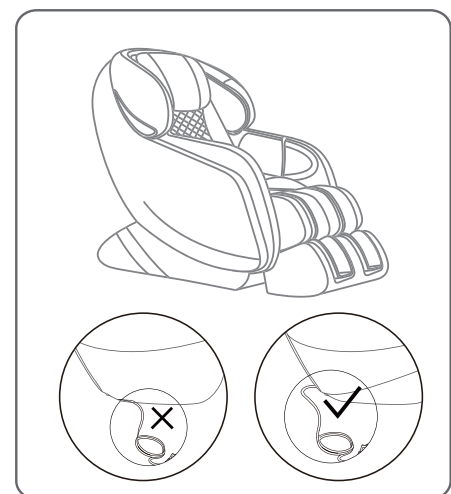
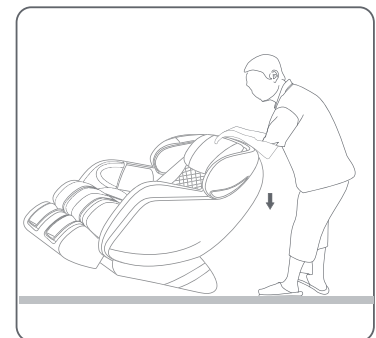
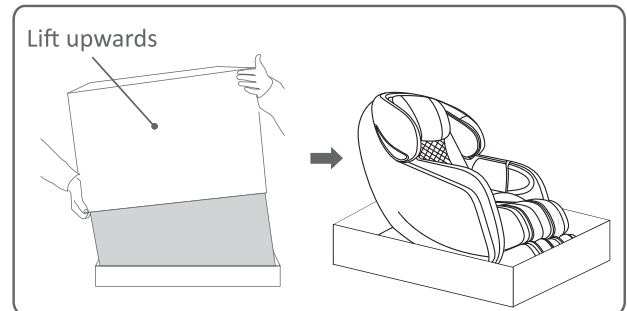

2.4 Overview

Side View

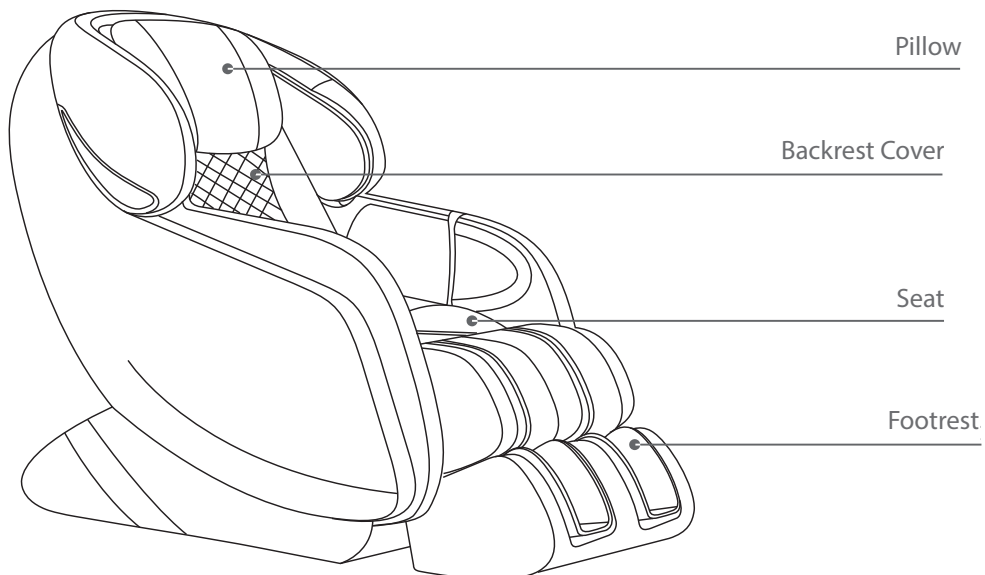

Rear View

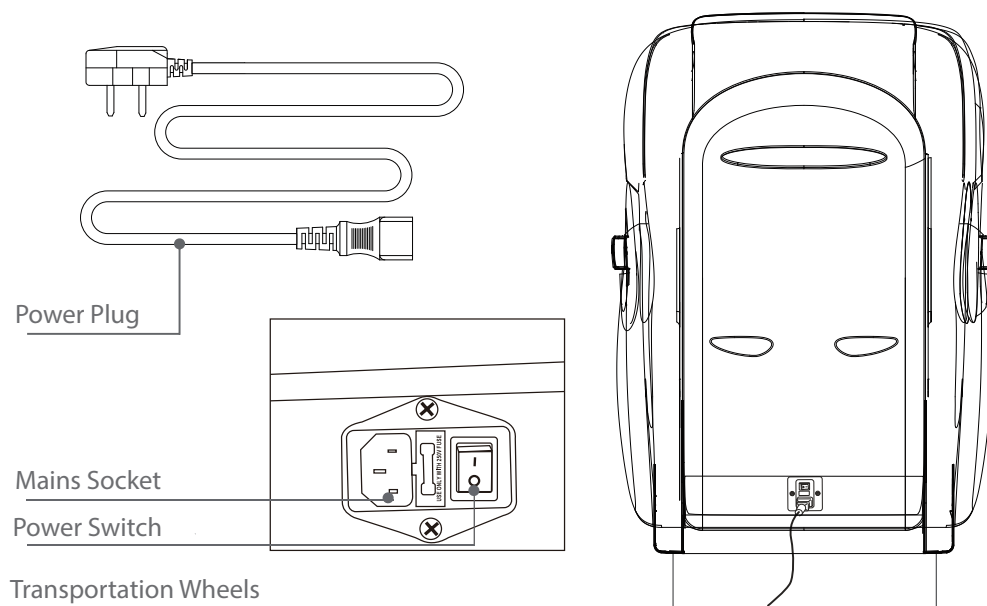

Internal Parts

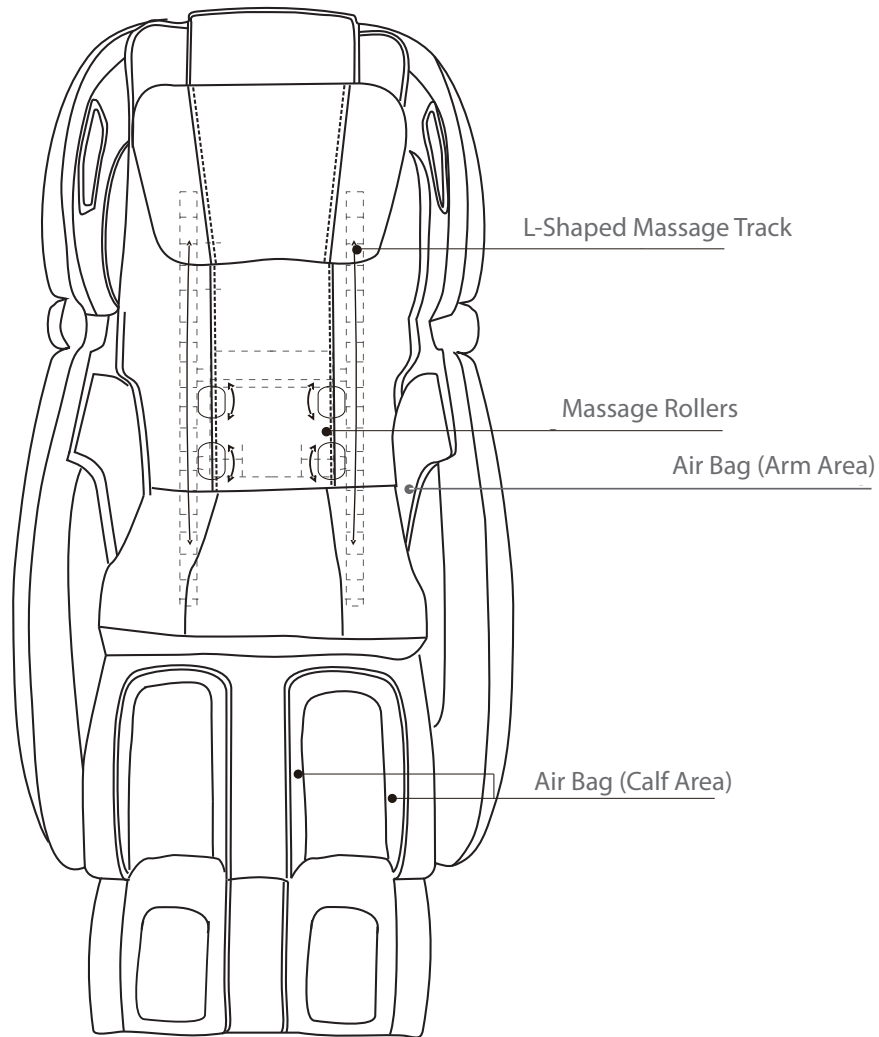

2.5 Adjusting to Body Height

The massage chair can be adjusted to the respective body height.

1. To adjust the massage chair to a large body height, lift the footrest slightly and pull the footrest in your direction.
2. To adjust the massage chair to a small body height, lift the footrest slightly and move the footrest towards the massage chair.

3 OPERATING INSTRUCTIONS

NOTICE

Familiarise yourself with all the functions and setting options of the device before starting training. Have the proper use of this product explained to you by a specialist.

3.1 Button and Function Description

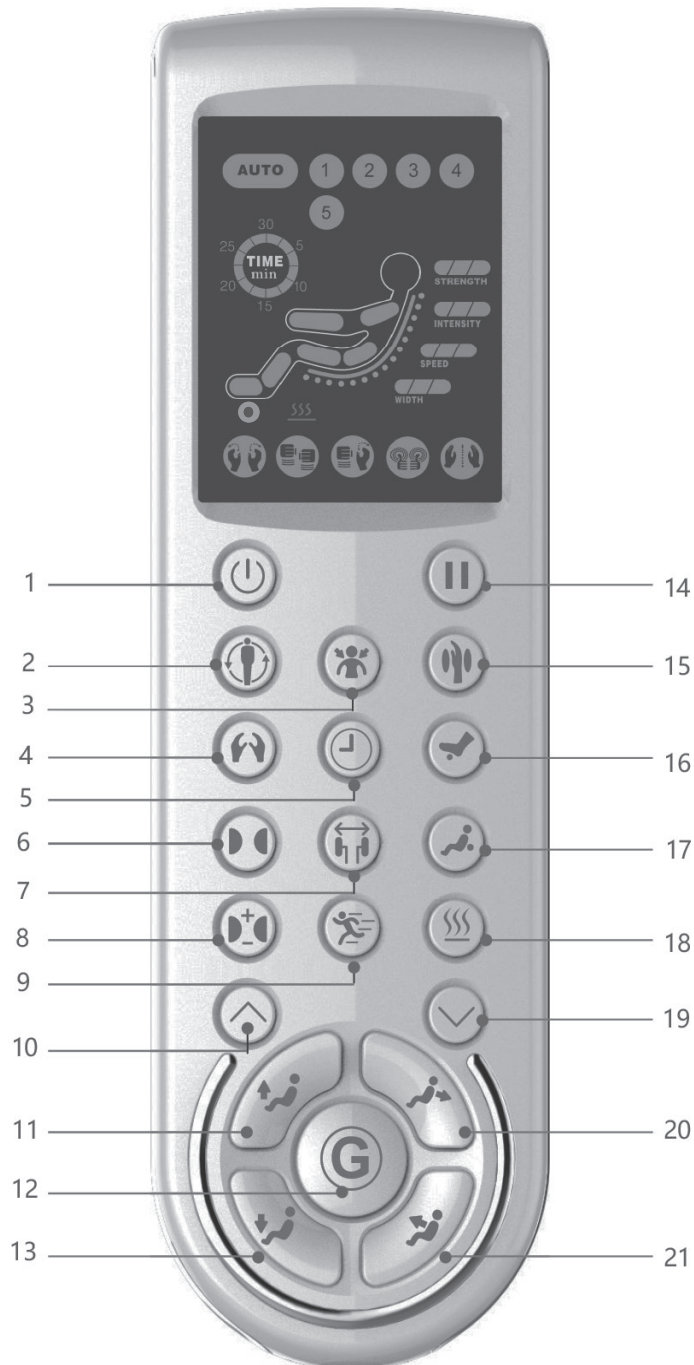

No.	Button	Description
1	On/Off	<ul style="list-style-type: none"> + Press to start and select a massage function. + Press again to stop the massage function and return to standby mode.
2	Automatic Programmes	<ul style="list-style-type: none"> + A choice of five automatic programmes: <ul style="list-style-type: none"> + Relax + After Work + Stretch + Sleep + A more detailed description of the individual programmes can be found in section 3.2.1. + The number of the selected programme is shown on the display.
3	Neck and Shoulder Massage	<p>ⓘ NOTICE The automatic programme will be stopped.</p> <ul style="list-style-type: none"> + Press to start or stop the neck and shoulder massage.
4	Manual Programmes	<ul style="list-style-type: none"> + A choice of five manual programmes: <ul style="list-style-type: none"> + Kneading + Tapping + Dual (Kneading and Tapping) + Shiatsu + Roller Massage + A more detailed description of the individual programmes can be found in section 3.2.2. + The selected programme is shown on the display.
5	Timer	<p>ⓘ NOTICE</p> <ul style="list-style-type: none"> + The standard duration is 15 minutes. + The maximum duration is 30 minutes. + Press to extend the timer by 5 minutes. + The remaining time is shown on the display.
6	Massage Zone (Air Pressure)	<ul style="list-style-type: none"> + Press to activate the air pressure massage and adjust the position of the massage zone. + The position of the massage zone is shown on the display.

7	Width Adjustment	<ul style="list-style-type: none"> + Press to cycle through three width settings. + The selected setting level is shown on the display (WIDTH).
8	Air Pressure Intensity	<ul style="list-style-type: none"> + Press to cycle through three air pressure intensities. + The current level of air pressure intensity is shown on the display (INTENSITY).
9	Massage Speed	<ul style="list-style-type: none"> + Press to cycle through three massage speeds. + The current massage speed level is shown on the display (SPEED). <p>ⓘ NOTICE Within some programmes, the massage intensity (STRENGTH) is also automatically adjusted when the speed is changed.</p>
10	Massage Position (Up)	<ul style="list-style-type: none"> + Press and hold to adjust the massage position upwards. + The massage position is shown on the display.
11	Footrest (Up)	<ul style="list-style-type: none"> + Press and hold to lift the footrest upwards.
12	Zero-Gravity	<ul style="list-style-type: none"> + Activate the Zero Gravity position. <p>ⓘ NOTICE The Zero Gravity position relieves the spine, joints and muscles.</p>
13	Footrest (Down)	<ul style="list-style-type: none"> + Press and hold to lower the footrest downwards.
14	Pause	<ul style="list-style-type: none"> + Press to pause the massage function. + Press again to resume the massage function.
15	Arm and Palm Massage (Air Pressure)	<ul style="list-style-type: none"> + Press to start or stop the arm and palm massage. + The activated arm and palm massage is shown on the display.
16	Foot Massage	<ul style="list-style-type: none"> + Press to start or stop the foot massage. + The activated foot massage is shown on the display.
17	Massage Zone	<p>ⓘ NOTICE Only available when using the manual programme.</p> <ul style="list-style-type: none"> + Press to select the massage zone.

18	Heat Function	<ul style="list-style-type: none"> + Press to activate/deactivate the heat function on the lower back. + The activated heat function is shown on the display.
19	Massage Position (Down)	<ul style="list-style-type: none"> + Press and hold to adjust the massage position downwards. + The massage position is shown on the display.
20	Backrest (Down)	<ul style="list-style-type: none"> + Press and hold to lower the backrest downwards.
21	Backrest (Up)	<ul style="list-style-type: none"> + Press and hold to lift the backrest upwards.

3.2 Programmes

The massage chair is equipped with four automatic and five manual programmes.

3.2.1 Automatic Programmes

1. To select one of the four automatic programmes, press the automatic programme button (2) repeatedly until you reach the desired programme.

The selected programme is indicated by a symbol in the upper display.

The massage chair performs a body sensing and then starts the programme.

2. You can now make further adjustments using the remote control.

NOTICE

Activating the neck and shoulder massage and adjusting the massage zone is not possible in the automatic programmes.

3. To change the programme, press the button for automatic programmes (2) again.
4. To pause the programme, press the pause button (14).
5. To end the programme, press the on/off button (1).

No.	Name	Area	Description
1	Relax	+ Whole Body	Use of the kneading, tapping and roller massage function for a relaxing full body massage.
2	After Work	+ Loin + Lower Back	Ideal against tensions in the lower back area after a long working day.
3	Stretch	+ Whole body with focus on: + Back + Hamstrings + Hands	Massage to stretch the muscles with focus on the back, hamstrings and hands.
4	Sleep	+ Whole Body	Tension-relieving, cradle-like movements that stimulate sleep.

3.2.2 Manual Programmes

1. To select one of the five manual programmes, press the manual programme button (4) repeatedly until you reach the desired programme.

The selected programme is indicated by a symbol in the lower display.

The massage chair performs a body sensing and then starts the programme.

2. You can now make further adjustments using the remote control.
3. To change the programme, press the button for manual programmes (4) again.
4. To pause the programme, press the pause button (14).
5. To end the programme, press the on/off button (1).

Name	Description
Kneading	+ Relieves deep-seated tensions + Strengthens musculature + Stimulates the blood circulation
Tapping	+ Stimulation of the muscle tissue + Indirect loosening of the muscle tissue by vibration of the tapping motion
Dual (Kneading and Tapping)	+ Combination of kneading and tapping
Shiatsu	+ Pressure Massage + Stimulation of the autonomic nervous system for regeneration, stress reduction and pain relief
Roller Massage	+ Stretches and relieves the spine

3.3 Wireless Connection

The massage chair is equipped with a wireless interface which makes it possible to play your own music via the built-in speakers of the massage chair.

To connect your device to the massage chair, open the wireless settings on your mobile device and connect it to "Music Station".

After connecting your mobile device to the massage chair, you can play your music through the speakers.



4.1 General Instructions

⚠ WARNING

- + The storage location should be chosen so that improper use by third parties or children can be prevented.
- + If your equipment does not have transportation wheels, the equipment must be disassembled before transportation.

▶ ATTENTION

- + Make sure that the equipment is protected from moisture, dust and dirt in the selected storage location. The storage location should be dry and well ventilated and have a constant ambient temperature between 10°C and 35°C.

4.2 Transportation Wheels

▶ ATTENTION

If you want to transport your equipment over particularly sensitive and soft floor coverings, such as parquet, planks or laminate, lay out the transport route with cardboard or similar to avoid possible floor damage.

1. Stand behind the equipment and lift it until the weight is transferred to the transportation wheels. After that, you easily can move the equipment to a new position. For long transport distances the equipment should be disassembled and safely packed.
2. Select the new location by following the instructions in the section 1.4 of this manual.

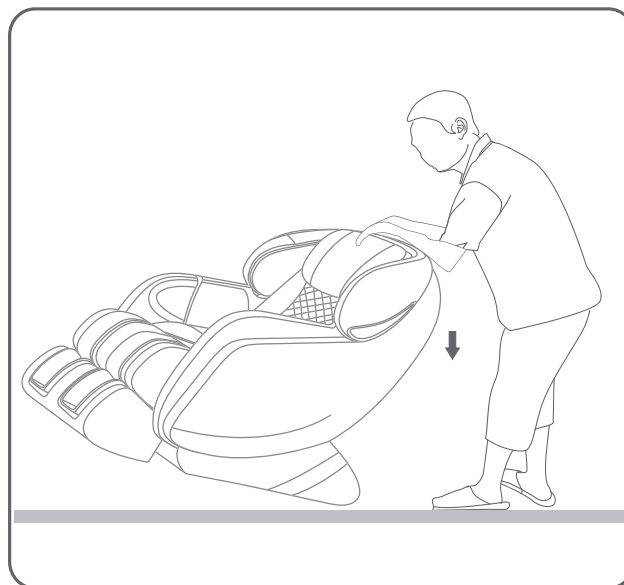

5.1 General Instructions

WARNING

- + Do not make any improper changes to the equipment.

CAUTION

- + Damaged or worn components may affect your safety and the life of the equipment. Therefore, immediately replace damaged or worn components. In such a case, contact the contract partner. The equipment must not be used until it has been repaired. If necessary, use only original spare parts.

ATTENTION

- + In addition to the instructions and recommendations for maintenance and care given here, additional service and/or repair work may be necessary; this must only be carried out by authorised service technicians.

5.2 Faults and Fault Diagnosis

The equipment undergoes regular quality controls during production. Nevertheless, faults or malfunctions may occur. Frequently, individual parts are responsible for these disturbances, an exchange is usually sufficient. Please refer to the following overview for the most common errors and how to correct them. If the equipment still does not function properly, contact your contract partner.

Fault	Cause	Solution
The device does not work	Interrupted power connection	+ Check cable connection + Power switch to on
	The automatic timer has expired	To switch the device on again, press the On/Off button
	Excessive use of the device	Disconnect the device from the mains socket and allow the device to cool down for at least 60 minutes before using it again.
	Heavy load on the device	Reduce the load on the device
The device is unusually warm	Excessive use of the device	Disconnect the device from the mains socket and allow the device to cool down for at least 60 minutes before using it again.
The device makes noise	Noise caused by the mechanical parts of the device	Noise during use of the device is normal. If the noises sound unusual (crackling, squeaking etc.), contact your contract partner.

5.3 Error Codes and Troubleshooting

The electronics of the equipment continuously carries out tests. In case of deviations, an error code appears on the display and normal operation is stopped for your safety.

Please contact the contract partner for technical support.

5.4 Maintenance and Inspection Calendar

To avoid damage from body sweat, the equipment must be cleaned with a damp towel (no solvents!) after each training session.

The following routine tasks must be performed at the specified intervals:

Part	Weekly	Monthly	Quarterly	Half-yearly	Yearly
Cushion	C		I		
Plastic covers	C	I			
Cable connections		I			
Legend: C = clean; I = inspect					

6 DISPOSAL

At the end of its operational life, this equipment cannot be disposed of in normal household waste. Instead, it must be disposed of via an electricals recycling centre. Further information can be obtained from your local authority’s recycling service.

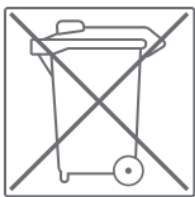

The materials can be recycled as per their symbols. Through the reuse, recycling of materials or other forms of recovery of old equipment, you make an important contribution to the protection of the environment.

7.1 Serial Number and Model Name

In order to provide you with the best possible service, please have the model name, article number, serial number, exploded drawing and parts list ready. The corresponding contact options can be found in chapter 9 of this operating manual.

NOTICE

The serial number of your equipment is unique. It's located on a white sticker. The exact position of this sticker is shown in the following illustration.

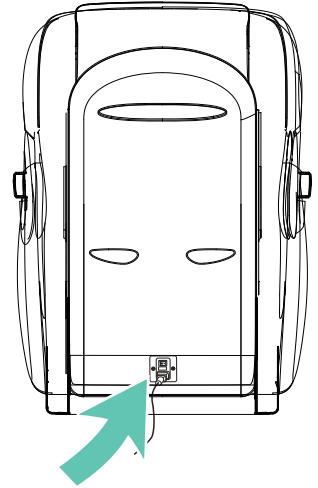

Enter the serial number in the appropriate field.

Serial number:

Brand / Category:

Model Name:

SKU:

Products from Taurus® are subject to strict quality control. However, if a fitness equipment purchased from us does not work perfectly, we take it very seriously and ask you to contact our customer service as indicated. We are happy to help you by phone via our service hotline.

Error Descriptions

Your fitness equipment is developed for long-term, high-quality training. However, should a problem arise, please first read the operating instructions. For further assistance, please contact your contract partner or call our service hotline. To ensure your problem is solved as quickly as possible, please describe the defect as exactly as possible.

In addition to the statutory warranty, we provide a warranty for every fitness equipment purchased from us according to the following provisions.

Your statutory rights are not affected.

Warrantee

The warrantee is the first/original buyer.

Warranty periods

The following warranty periods begin on delivery of the fitness equipment.

Warranty period

The warranty periods, shown on our web shop, begin on delivery of the fitness equipment. The respective warranty periods for your equipment can be found on its product website.

Repair Costs

According to our choice, there will either be a repair, a replacement of individual damaged parts or a complete replacement. Spare parts, that have to be mounted while assembling the equipment, have to be replaced by the warrantee personally and are not a part of repair. After the expiration of the warranty period, the responsibility for parts costs, repair costs, installation costs and delivery costs lies with the warranty holder.

The terms of use are defined as follows:

- + Home use: solely for private use in private households up to 3 hours per day
- + Semi-professional use: up to 6 hours per day (e. g. rehabilitation centres, hotels, clubs, company gyms)
- + Professional use: more than 6 hours per day (e. g. commercial gyms)

Warranty Service

Within the warranty period, equipment which develops faults as a result of material or manufacturing defects, will be repaired or replaced at our discretion. Ownership of equipment or parts of equipment which have been replaced is transferred to us. The warranty period is not extended nor does a new warranty period begin following repair or replacement under the warranty.

Warranty Conditions

For the warranty to be valid, the following steps must be taken:

Please contact our customer service by email or phone. If the product under warranty has to be sent in for repair, the seller bears costs. After expiry of the warranty, the buyer bears the costs of transport and insurance. If the fault is covered by our warranty, you will receive a new or repaired equipment in return.

Warranty claims are invalid in case of damage resulting from:

- + misuse or improper handling
- + environmental influences (moisture, heat, electrical surge, dust, etc.)
- + failure to follow the current safety measures for the equipment
- + failure to follow the operating instructions
- + use of force (e. g. hitting, kicking, falling)
- + interventions which were not carried out by one of our authorized service centres
- + unauthorised repair attempts

Proof of Purchase and Serial Number

Please make sure that you are able to provide the appropriate receipt when claiming on your warranty. So that we can clearly identify the model of your equipment, and for the purposes of our quality control, you will need to give the serial number of your equipment, when contacting the service team. Where possible please have your serial number and your customer number ready when you call our service hotline. It will help us to deal with your request swiftly.

If you cannot find the serial number on your fitness equipment, our service team is at your disposal to offer further information.

Service outside of the Warranty Period

We are also happy to issue an individual cost estimate if there is a problem with your fitness equipment after the warranty has expired, or in cases which do not fall under the terms of the warranty, e. g. normal wear and tear. Please contact our customer service team to find a quick and cost-effective solution to your problem. In such a case you will be responsible for the delivery costs.

Communication

Many problems can be solved just by speaking to us as your specialist supplier. We know how important it is to you as a user of the fitness equipment to have problems solved quickly and simply, so you can enjoy working out with minimal interruption. For that reason, we also want to resolve your queries quickly and in a straightforward manner. Thus, please always keep your customer number and the serial number of the faulty equipment handy.



DE	DK	UK
<p>TECHNIK</p> <p>☎ +49 4621 4210-900 ☎ +49 4621 4210-698 ✉ technik@fitshop.de 🕒 Öffnungszeiten entnehmen Sie unserer Homepage.</p> <p>SERVICE</p> <p>☎ 0800 20 20277 (kostenlos) ☎ 04621 4210 - 0 ✉ info@fitshop.de 🕒 Öffnungszeiten entnehmen Sie unserer Homepage: https://stg.fit/statita</p>	<p>TEKNIK OG SERVICE</p> <p>☎ 80 90 16 50 +49 4621 4210-945 ✉ info@fitshop.dk 🕒 Åbningstider kan findes på hjemmesiden: https://stg.fit/statit7</p>	<p>CUSTOMER CARE POWERHOUSE</p> <p>☎ +44 141 737 2249 or +44 141 876 3972 ✉ customercare@fitshop.co.uk 🕒 You can find the opening hours on our homepage: https://stg.fit/statitd</p>
	FR	BE
	<p>TECHNIQUE & SERVICE</p> <p>☎ +33 (0) 189 530984 +49 4621 42 10 933 ✉ info@fitshop.fr 🕒 Vous trouverez les heures d'ouverture sur notre site Internet: https://stg.fit/statit4</p>	<p>TECHNIQUE & SERVICE</p> <p>☎ 02 732 46 77 +49 4621 4210 933 ✉ info@fitshop.be 🕒 Vous trouverez les heures d'ouverture sur notre site Internet: https://stg.fit/statit8</p>
ES	NL	INT
<p>TECNOLOGÍA Y SERVICIOS</p> <p>☎ 911 238 029 ✉ info@fitshop.es 🕒 Consulta nuestro horario de apertura en la página web: https://stg.fit/statit5</p>	<p>TECHNISCHE DIENST & SERVICE</p> <p>☎ +31 172 619961 ✉ service@fitshop.nl 🕒 De openingstijden vindt u op onze homepage: https://stg.fit/statit3</p>	<p>TECHNICAL SUPPORT & SERVICE</p> <p>☎ +49 4621 4210-944 ✉ service-int@fitshop.de 🕒 You can find the opening hours on our homepage: https://stg.fit/statita</p>
PL	AT	CH
<p>DZIAŁ TECHNICZNY I SERWIS</p> <p>☎ 22 307 43 21 +49 4621 42 10-948 ✉ info@fitshop.pl 🕒 Godziny otwarcia można znaleźć na stronie głównej: https://stg.fit/statit6</p>	<p>TECHNIK & SERVICE</p> <p>☎ 0800 20 20277 (Freecall) +49 4621 42 10-0 ✉ info@fitshop.at 🕒 Öffnungszeiten entnehmen Sie unserer Homepage: https://stg.fit/statitb</p>	<p>TECHNIK & SERVICE</p> <p>☎ 0800 202 027 +49 4621 42 10-0 ✉ info@fitshop.ch 🕒 Öffnungszeiten entnehmen Sie unserer Homepage: https://stg.fit/statit9</p>

Please find a detailed overview including address and opening hours for all stores of Powerhouse Fitness in the UK on the following website:

www.fitshop.co.uk/storelocator



WE LIVE FITNESS

WEBSHOP AND SOCIAL MEDIA

The Fitshop Group is Europe's largest specialist for home fitness equipment with currently 70 stores and one of the world's most renowned online mail order companies for fitness equipment.

Powerhouse Fitness is part of the Fitshop Group. Private customers order via the 25 web shops in the respective national language or have their desired equipment assembled on site. In addition, the company supplies fitness studios, hotels, sports clubs, companies and physio practices with professional equipment for endurance and strength training.

The Fitshop group offers a wide range of fitness equipment from renowned manufacturers, high-quality in-house developments and comprehensive services, such as a build-up service and sports scientific advice before and after the purchase. The company employs numerous sports scientists, fitness trainers and competitive athletes.

Visit us also on our social media platforms or our blog!



<https://www.fitshop.co.uk/>
www.fitshop.co.uk/blog



www.facebook.com/fitshop.co.uk



www.instagram.com/fitshop_uk



www.youtube.com/@fitshop_uk

TAURUS

 cardiostrong

BODYCRAFT

BodyMax





