

# TAURUS®

## Assembly and Operating Instructions

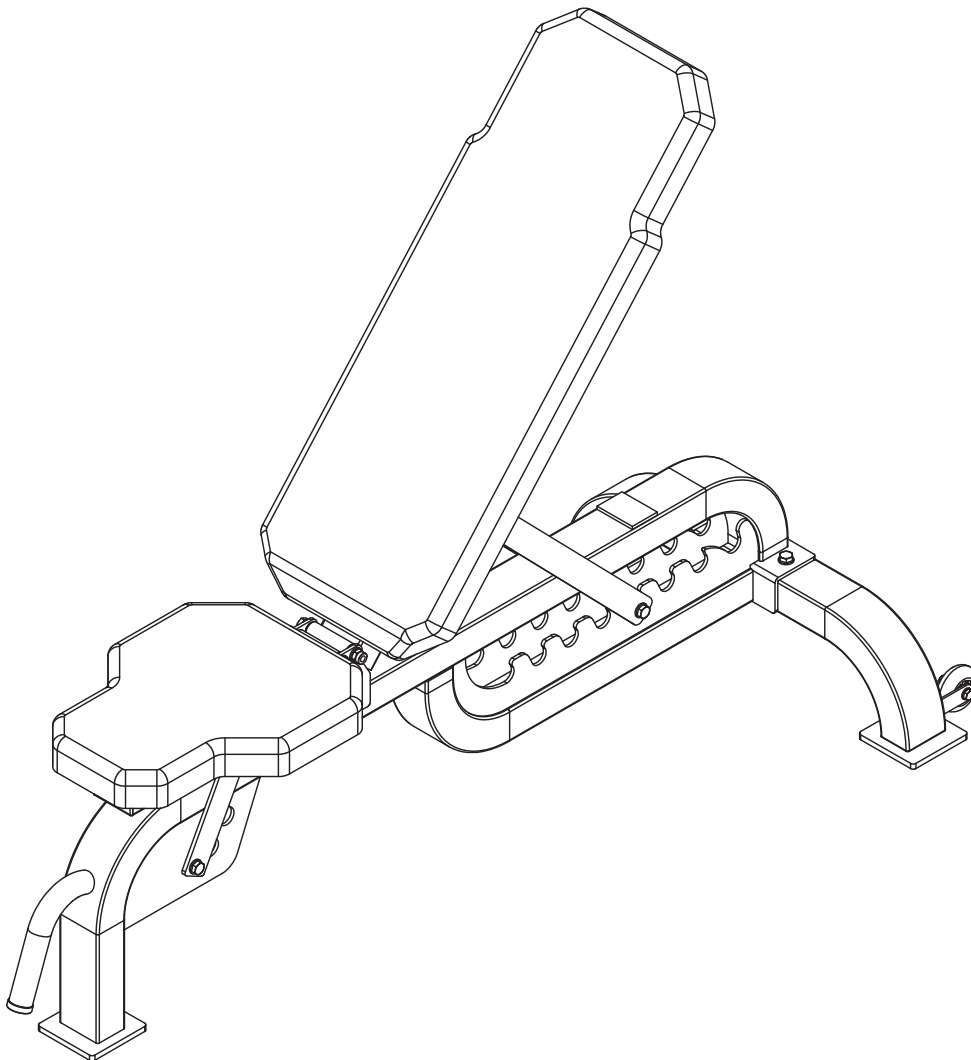

max. 500 kg



~ 45 Min.



34 kg

L 147 | W 74 | H 43

FSUKSEBR2582.01.01

SKU: SEBR2582

**Taurus Weigh Bench B950**



# Content

<b>1</b>	<b>GENERAL INFORMATION</b>	<b>8</b>
1.1	Technical Data	8
1.2	Personal Safety	9
1.3	Set-Up Place	10
<b>2</b>	<b>ASSEMBLY</b>	<b>11</b>
2.1	General Instructions	11
2.2	Scope of Delivery	12
2.3	Assembly	15
<b>3</b>	<b>STORAGE AND TRANSPORT</b>	<b>18</b>
3.1	General Instructions	18
3.2	Transportation Wheels	18
<b>4</b>	<b>TROUBLESHOOTING, CARE AND MAINTENANCE</b>	<b>19</b>
4.1	General Instructions	19
4.2	Faults and Fault Diagnosis	19
4.3	Maintenance and Inspection Calendar	20
<b>5</b>	<b>DISPOSAL</b>	<b>20</b>
<b>6</b>	<b>RECOMMENDED ACCESSORIES</b>	<b>21</b>
<b>7</b>	<b>ORDERING SPARE PARTS</b>	<b>22</b>
7.1	Serial Number and Model Name	22
7.2	Parts List	23
7.3	Exploded Drawing	24
<b>8</b>	<b>WARRANTY</b>	<b>25</b>
<b>9</b>	<b>CONTACT</b>	<b>27</b>



**Dear customer,**

Thank you for choosing a high-quality equipment of the brand TAURUS®. Taurus offers sports and fitness equipment for the sophisticated home sport and the equipment of fitness studios and business customers. With Taurus fitness equipment, the focus is on what sport is all about: maximum performance! Therefore, the equipment is developed in close consultation with athletes and sports scientists. Because athletes know best what makes perfect fitness equipment.

Further information can be found at [www.fitshop.co.uk](http://www.fitshop.co.uk)

**Intended Use**

The equipment may only be used for its intended purpose.

The equipment is suitable for home use and semi-professional use (e.g. hospitals, clubs, hotels, schools, etc.). The equipment is not suitable for commercial or professional use (e.g. fitness studio).

**Legal Notice**

Fitshop GmbH  
Europe's No. 1 for home fitness

International Headquarters  
Flensburger Straße 55  
24837 Schleswig  
Germany

Management:  
Christian Grau  
Sebastian Campmann  
Dr. Bernhard Schenkel  
No. HRB 1000 SL  
Local Court Flensburg  
European VAT Number: DE813211547

**Disclaimer**

© TAURUS is a registered brand of the company Fitshop GmbH. All rights reserved. Any use of this trademark without the explicit written permission of Fitshop is prohibited.

Product and manual are subject to change. Technical data can be changed without advance notice.

# **FITSHOP**

Europe's No.1 for Home Fitness

## ABOUT THIS MANUAL

Please carefully read the entire manual before installation and first use. The manual will help you to quickly set up the system and explains how to safely use it. Make sure that all persons exercising with the equipment (especially children and persons with physical, sensory, mental or motor disabilities) are informed about this manual and its contents in advance. In case of doubt, responsible persons must supervise the use of the equipment.

Due to ongoing changes and software optimisations, the manual may have to be updated. If you notice any discrepancies during assembly or use, please refer to the manual uploaded to the webshop. The latest manual is always available there.



This equipment has been manufactured according to the latest safety knowledge. As far as possible, potential safety hazards which could cause injury have been eliminated. Make sure to carefully follow the instructions and that all parts are securely in place. If required, read through the instructions again to correct any mistakes.

Training devices must be classified according to accuracy and use. Accuracy classes are only applicable to devices that display training data.

### Accuracy classes

Class A: high accuracy.

Class B: medium accuracy.

Class C: low accuracy.

The use classes explain the intended use of the training device.

### Use classes

**Class S** (studio): professional and/or commercial use.

These training devices are intended for the use in training rooms of facilities such as sports clubs, school facilities, hotels, clubs and studios whose access and supervision is specifically regulated by the owner (person with legal responsibility).

**Class H** (home use): use at home.

These stationary training devices are intended for the use in private homes where access to the training device is regulated by the owner (person with legal responsibility).

Please pay close attention to the safety and maintenance instructions given here. The contract partner cannot be held liable for damage to health, accidents or damage to the equipment when it is not used in accordance with these instructions.

The following safety instructions may appear in this manual:

► **ATTENTION**

This notice indicates potentially hazardous situations which, if not avoided, may result in property damage.

⚠ **CAUTION**

This notice indicates potentially hazardous situations which, if not avoided, may result in slight or minor injuries!

⚠ **WARNING**

This notice indicates potentially hazardous situations which, if not avoided, may result in death or serious injuries!

⚠ **DANGER**

This notice indicates potentially hazardous situations which, if not avoided, will result in death or serious injuries!

ⓘ **NOTICE**

This notice indicates further useful information.

Retain these instructions in a safe place for future reference, maintenance or when ordering replacement parts.

## 1.1 Technical Data

### Weight and dimensions:

Article weight (gross, including packaging):	38 kg
Article weight (net, without packaging):	34 kg
Packaging dimensions (L x W x H):	141 cm x 47 cm 20 cm
Set-up dimensions (L x W x H):	147 cm x 73.6 cm x 43.2 cm
Maximum load:	500 kg
+ Maximum training weight:	350 kg
+ Maximum user weight:	150 kg
Use class:	S



## 1.2 Personal Safety

### **DANGER**

- + Before you start using the equipment, you should consult your physician that this type of exercise is suitable for you from a health perspective. Particularly affected are persons who: have a hereditary disposition to high blood pressure or heart disease, are over the age of 45, smoke, have high cholesterol values, are overweight and/or have not exercised regularly in the past year. If you are under medical treatment that affects your heart rate, medical advice is absolutely essential.
- + Note that excessive training can seriously endanger your health. Please also note that heart rate monitoring systems can be inaccurate. If you notice any signs of weakness, nausea, dizziness, pain, shortness of breath, or other abnormal symptoms, stop exercising immediately and seek advice from your doctor if necessary.
- + The owner must communicate all warnings and instructions to the user.

### **WARNING**

- + This equipment may not be used by children under the age of 14.
- + Children should not be allowed unsupervised access to the equipment.
- + Persons with disabilities must have a medical license and must be under strict observation when using the equipment.
- + The equipment is strictly for use by one person at a time.
- + Keep your hands, feet and other body parts, hair, clothing, jewellery and other objects well clear of moving parts.
- + During use, wear suitable sports clothing rather than loose or baggy clothing. When wearing sports shoes, make sure they have suitable soles, preferably made of rubber or other non-slip materials. Shoes with heels, leather soles, studs or spikes are unsuitable. Never exercise barefoot.
- + Always start each workout with a light warm-up and end with a cool-down phase.
- + Using the machine as a support during stretching exercises or attaching resistance bands, ropes or other accessories to it, may cause injuries.

### **CAUTION**

- + If your equipment needs to be connected to the power supply with a mains cable, make sure that the cable is not a potential tripping hazard.
- + Make sure that nobody is within the range of motion of the equipment during training so as not to endanger you or other persons.
- + Be aware that if adjustment devices are left protruding, they may impede the user's movement.
- + The weights should remain in the user's field of vision during the entire exercise to prevent danger to third parties.

### **ATTENTION**

- + Do not insert any objects of any kind into the openings of the device.

## 1.3 Set-Up Place

### **WARNING**

- + Do not place the equipment in main corridors or escape routes.

### **CAUTION**

- + Choose a location in which to place the equipment such that there is enough free space/clearance to the front, the rear and to the sides of the equipment.
- + The training room should be well ventilated during training and not be exposed to any draughts.
- + Choose the place in which to set up the equipment such that there is enough free space/clearance to the front, the rear and to the sides of the equipment.
- + The free area in the direction from which the exercise equipment is accessed must be at least 0.6 m larger than the exercise area.
- + The set-up and mounting surface of the equipment should be flat, loadable and solid.
- + If your device is to be mounted on the wall/ceiling, make sure that you use the appropriate assembly material to avoid possible damages or personal injuries. The contractual partner accepts no liability for this.

### **ATTENTION**

- + The device may only be used in one building, in sufficiently tempered and dry rooms (ambient temperatures between 10°C and 35°C). The equipment should not be used outdoors or in rooms with high humidity (over 70%) like swimming pools.
- + A floor protective mat/equipment underlay can help to protect high-quality floor coverings (parquet, laminate, cork, carpets) from dents and sweat and can help to level out slight unevenness.
- + For Class S equipment, the exercise equipment may only be used in areas where access, supervision and control are specifically regulated by the owner.

### 2.1 General Instructions



#### **DANGER**

- + Do not leave any tools, packaging materials such as foils or small parts lying around, as otherwise there is a danger of suffocation for children. Keep children away from the equipment during assembly.



#### **WARNING**

- + Pay attention to the instructions attached to the equipment in order to reduce the risk of injuries.



#### **CAUTION**

- + Ensure to have sufficient room for movement in each direction during assembly.
- + The assembly of the equipment must be carried out by at least two adults. If in doubt, seek the help of a third technically skilled person.



#### **ATTENTION**

- + To prevent damage to the equipment and the floor, assemble the equipment on a mat or packaging board.



#### **NOTICE**

- + In order to make the assembly as simple as possible, some screws and nuts to be used can already be pre-assembled.
- + Ideally, assemble the equipment at its later set-up place.

## 2.2 Scope of Delivery





The scope of delivery consist of the following parts. At the beginning, check whether all parts and tools belonging to the device are included in the scope of delivery and whether damage has occurred. In the event of complaints, the contractual partner must be contacted directly.



**⚠ CAUTION**

If parts of the scope of delivery are missing or damaged, the assembly must not be carried out.

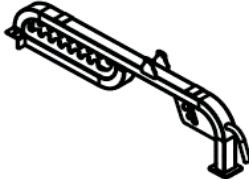
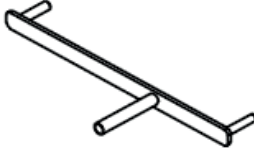
Required tools (Included in scope of delivery):

- + 10 mm / 13 mm / 14 mm / 17 mm / 19 mm wrench / socket
- + Philips head screwdriver
- + 5 mm Allen wrench

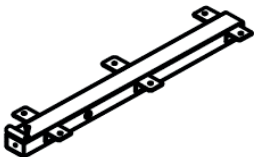
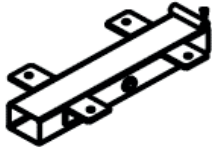
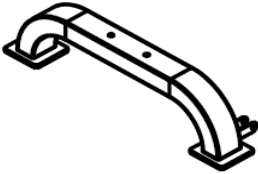
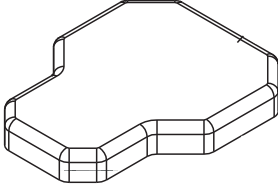
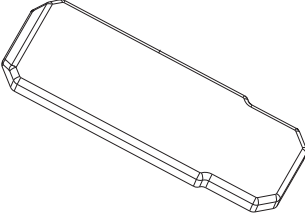
Number	Name		Qty.
1	Joint Plate		1
2	Front Joint Plate		1
3	Main Frame		1
4	Back Adjustment		1
5	Seat Adjustment		1

6	Backrest Support		1
7	Seat Support		1
8	Rear Frame		1
9	Seat Cushion		1
10	Backrest		1
11	Screw Pack		1
12	Manual		1

#25-10 × 12PCS

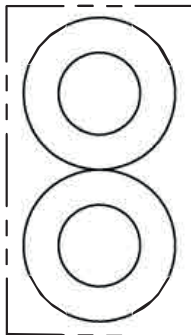

#24-8 × 10PCS

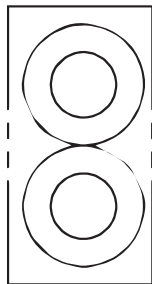

#23-M10\*100 × 2PCS

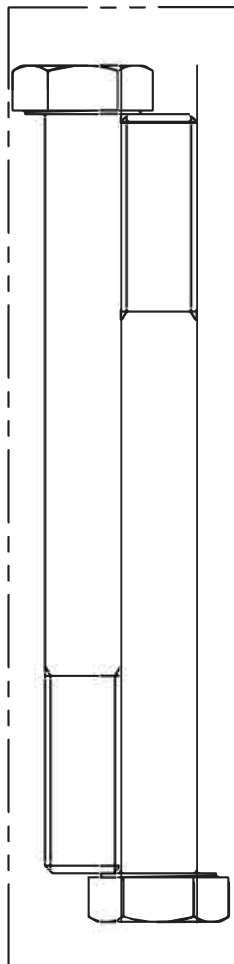

#19-M8\*25 × 10PCS

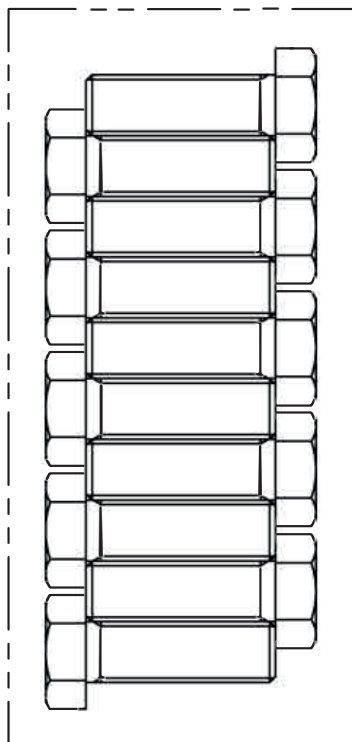

#22-M10\*70 × 2PCS

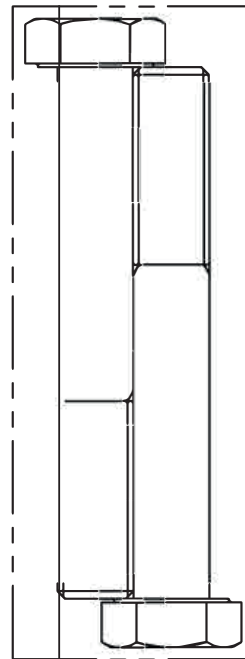

#27-M10 × 4PCS

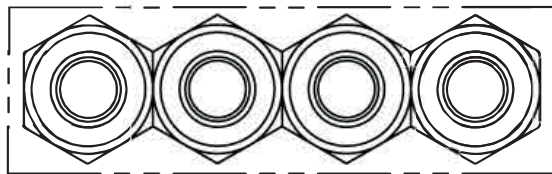

#21-M10\*25 × 4PCS

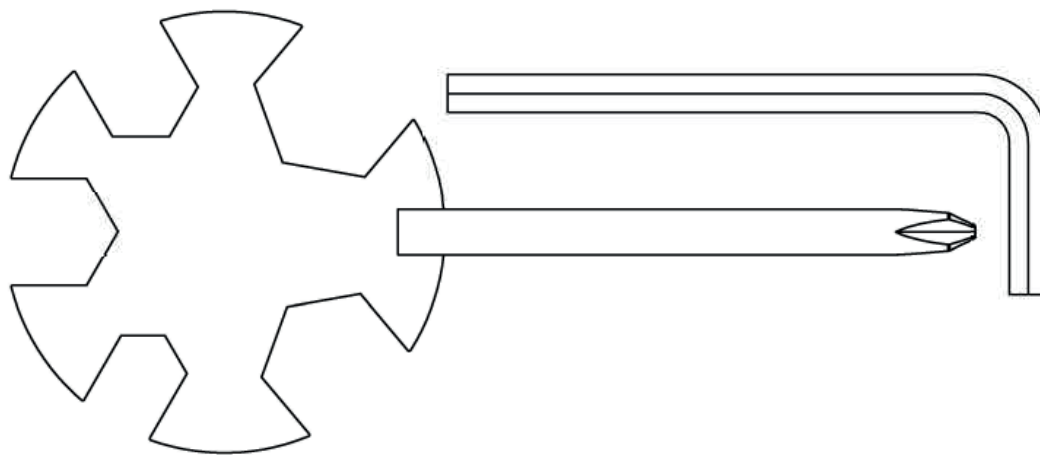
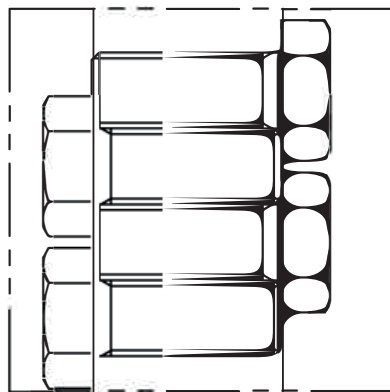

## 2.3 Assembly

Before assembly, take a close look at the individual assembly steps shown and carry out the assembly in the order given.

### ① NOTICE

- + First loosely screw all parts together and check that they fit properly. Tighten the screws using the tool only when you are instructed to do so.
- + If you have difficulty recognising the graphics, we recommend that you open and/or download the PDF instructions stored in the webshop on your end device (e.g. smartphone, tablet or PC). There you have the option of zooming in closer. Please note that the Adobe Acrobat Reader programme must be installed on your end device in order to open the file.

### Step 1: Assembly of the Frames

1. Attach the two wheels (17) to the rear frame (2) with two screws (20), four washers (24) and two lock nuts (26).
2. Attach the rear frame (2) to the main frame (1) with two screws (22), four washers (25) and two lock nuts (27).

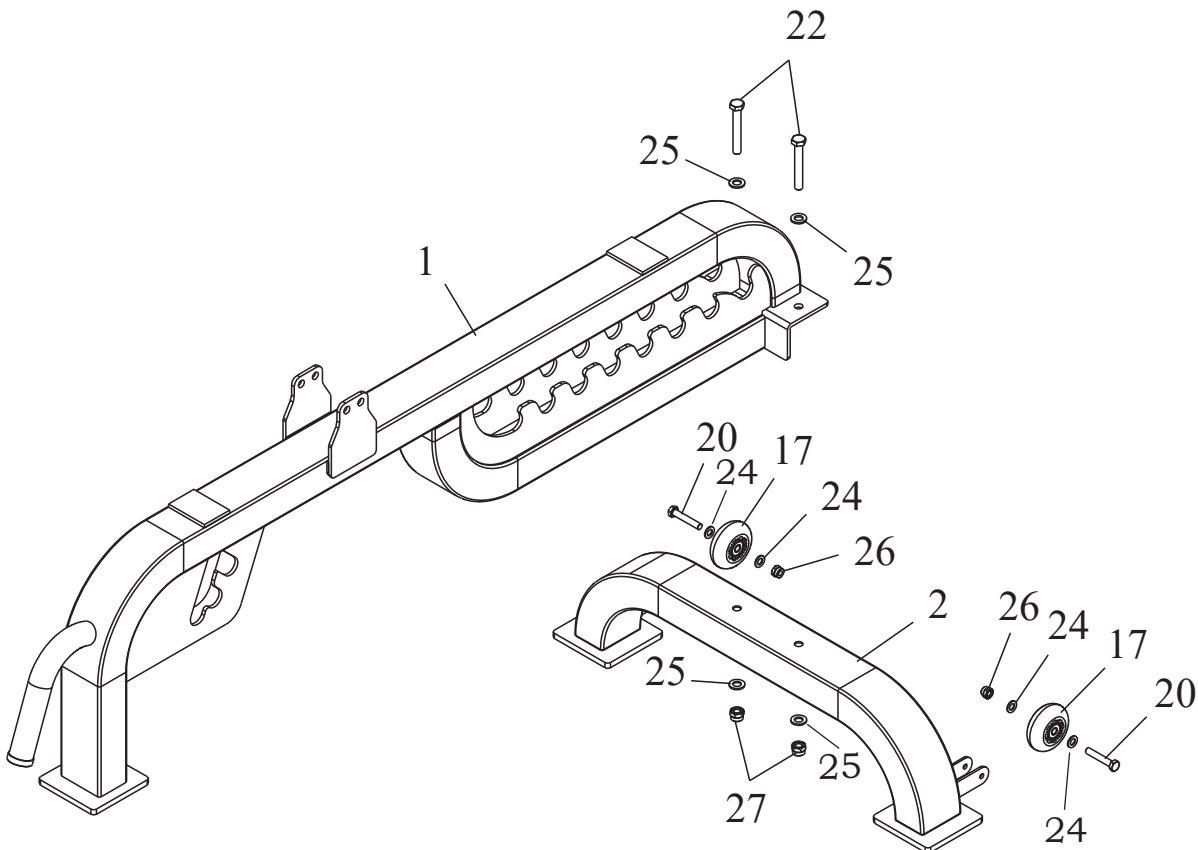





### Step 3: Assembly of the Backrest

1. Attach the seat support (4) to the main frame (1) with one screw (23), two washers (25) and one lock nut (27).
2. Insert the small axis of the seat adjustment (7) into the hole of the seat support (4).
3. Insert the large axis of the seat adjustment (7) into one of the seat incline notches of the main frame (1).
4. Attach the front joint plate (11) to the seat adjustment (7) with two screws (21) and two washers (25).
5. Attach the seat cushion (9) to the seat support (4) with four screws (19) and four washers (24).

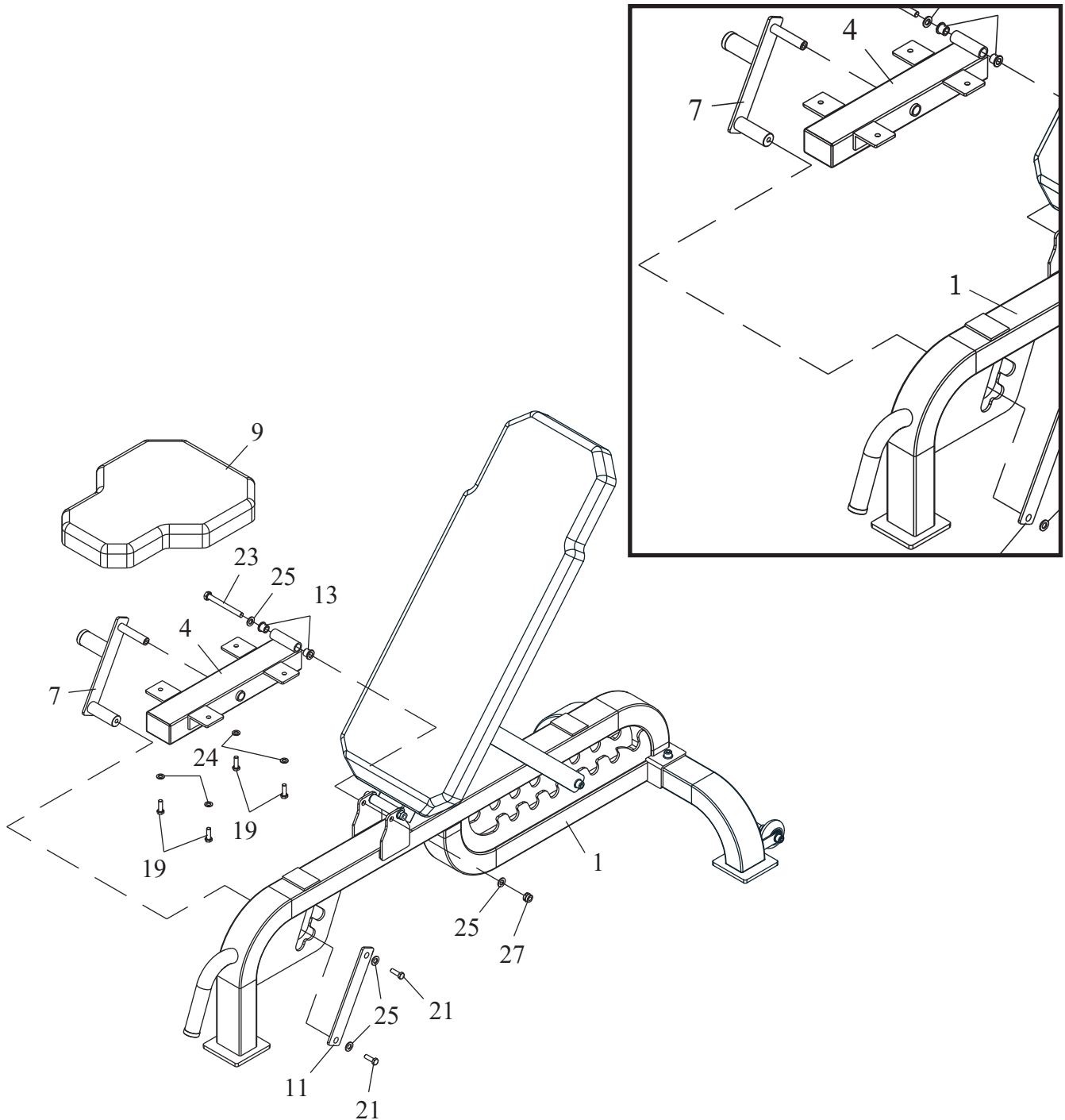

### 3.1 General Instructions

**⚠ WARNING**

- + The storage location should be chosen so that improper use by third parties or children can be prevented.
- + If your equipment does not have transportation wheels, the equipment must be disassembled before transportation.

**▶ ATTENTION**

- + Make sure that the equipment is protected from moisture, dust and dirt in the selected storage location. The storage location should be dry and well ventilated and have a constant ambient temperature between 10°C and 35°C.

### 3.2 Transportation Wheels

**▶ ATTENTION**

If you want to transport your equipment over particularly sensitive and soft floor coverings, such as parquet, planks or laminate, lay out the transport route with cardboard or similar to avoid possible floor damage.

1. Stand behind the equipment and lift it until the weight is transferred to the transportation wheels. After that, you easily can move the equipment to a new position. For long transport distances the equipment should be disassembled and safely packed.
2. Select the new location by following the instructions in the section 1.3 of this manual.

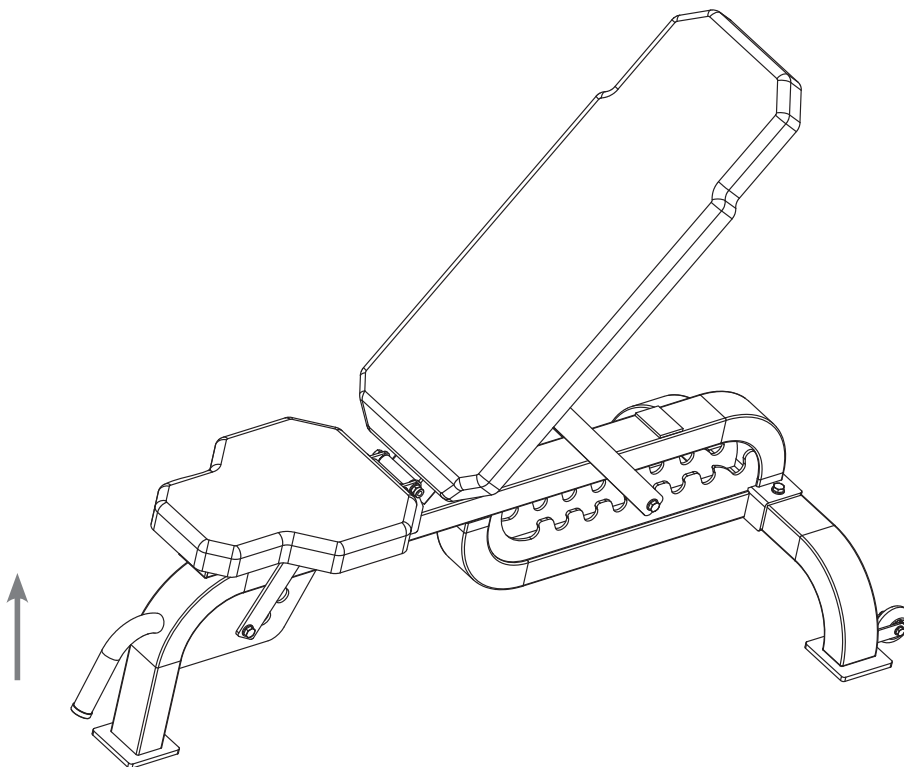

## 4.1 General Instructions



### WARNING

- + Do not make any improper changes to the equipment.



### CAUTION

- + Damaged or worn components may affect your safety and the life of the equipment. Therefore, immediately replace damaged or worn components. In such a case, contact the contract partner. The equipment must not be used until it has been repaired. If necessary, use only original spare parts.

### ► ATTENTION

- + In addition to the instructions and recommendations for maintenance and care given here, additional service and/or repair work may be necessary; this must only be carried out by authorised service technicians.

## 4.2 Faults and Fault Diagnosis

The equipment undergoes regular quality controls during production. Nevertheless, faults or malfunctions may occur. Frequently, individual parts are responsible for these disturbances, an exchange is usually sufficient. Please refer to the following overview for the most common errors and how to correct them. If the equipment still does not function properly, contact your contract partner.

Fault	Cause	Solution
Squeaking & cracking noises	Screw connections loosened or too tight	+ Check or lubricate screw connections*
Unit wobbles	+ Uneven ground + Loose screw connections	+ Align unit + Tighten screw connections

\* With a grease-free silicone oil or silicone spray.

### 4.3 Maintenance and Inspection Calendar

To avoid damage from body sweat, the equipment must be cleaned with a damp towel (no solvents!) after each training session.

The following routine tasks must be performed at the specified intervals:

Part	Weekly	Monthly	Quarterly
Screw connections		I	
Cushions	C		
Legend: C = clean; I = inspect			

## 5 DISPOSAL

At the end of its operational life, this equipment cannot be disposed of in normal household waste. Instead, it must be disposed of via an recycling centre. Further information can be obtained from your local authority's recycling service.



The materials can be recycled as per their symbols. Through the reuse, recycling of materials or other forms of recovery of old equipment, you make an important contribution to the protection of the environment.

## 6 RECOMMENDED ACCESSORIES

To make your training experience even more efficient and pleasant, we recommend that you add suiting accessories to your fitness equipment. For training equipment like smith machines, weight benches or racks this could for example be a **floor mat**, which makes your fitness equipment stand more securely and also protects the floor from sweat but it could be also **additional weights, handles, foot straps** for leg exercises or **triceps ropes**. For some smith machines, there are also optional add-ons such as **leg presses** that make your workout even more intense and comprehensive.

Our range of accessories offers the highest quality and makes training even better. If you would like to find out more about compatible accessories, please go to the detail page of the product in our webshop (the easiest way is to enter the article number in the search field above) and go to the recommended accessories on this page. Of course, you can also contact our customer service: by telephone, e-mail, in one of our branches or via our social media channels. We will be happy to advise you!



floor mat



chest strap



tricep and curl bar



triceps rope

## 7.1 Serial Number and Model Name

In order to provide you with the best possible service, please have the model name, article number, serial number, exploded drawing and parts list ready. The corresponding contact options can be found in chapter 9 of this operating manual.

**NOTICE**

The serial number of your equipment is unique. It's located on a white sticker. The exact position of this sticker is shown in the following illustration.

Enter the serial number in the appropriate field.

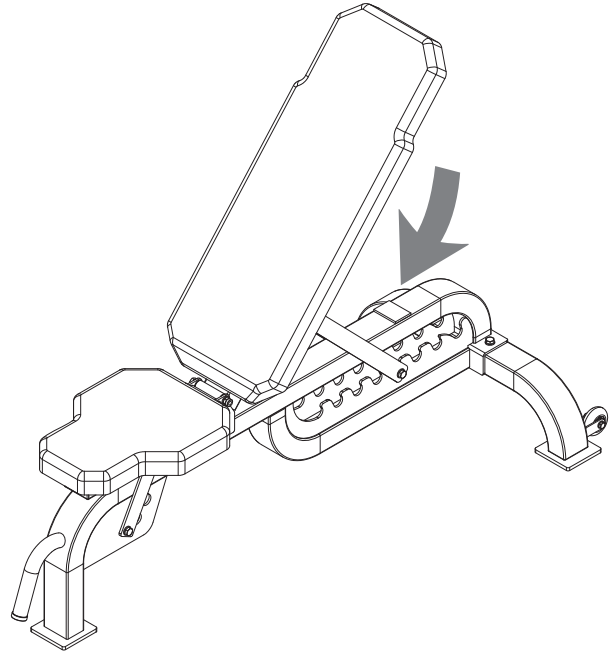

**Serial number:**

**Brand / Category:**

Taurus / multi gym

**Model Name:**

Weight Bench B950

**SKU:**

SEBR2582

## 7.2 Parts List

No.	Name	Qty.
1	MAIN FRAME	1
2	REAR FRAME	1
3	BACKREST SUPPORT	1
4	SEAT SUPPORT	1
5	BACK ADJUSTMENT	1
6	JOINT PLATE	1
7	SEAT ADJUSTMENT	1
8	SHEATHING	3
9	SEAT CUSHION	1
10	BACKREST	1
11	FRONT JOINT PLATE	1
12	RECTANGULAR PLUG	2
13	BUSHING	4
14	SHORT FOAM ROLLER	1
15	FOAM ROLLER	1
16	LONG FOAM ROLLER	1
17	WHEEL	2
18	M8X25MM SOCKET SCREW	3
19	M8X25MM SCREW	10
20	M8X45 MM SCREW	2
21	M10X25MM SCREW	4
22	M10X70MM SCREW	2
23	M10X100MM SCREW	2
24	8MM WASHER	14
25	10MM WASHER	12
26	M8 LOCK NUT	2
27	M10 LOCK NUT	4

# 7.3 Exploded Drawing

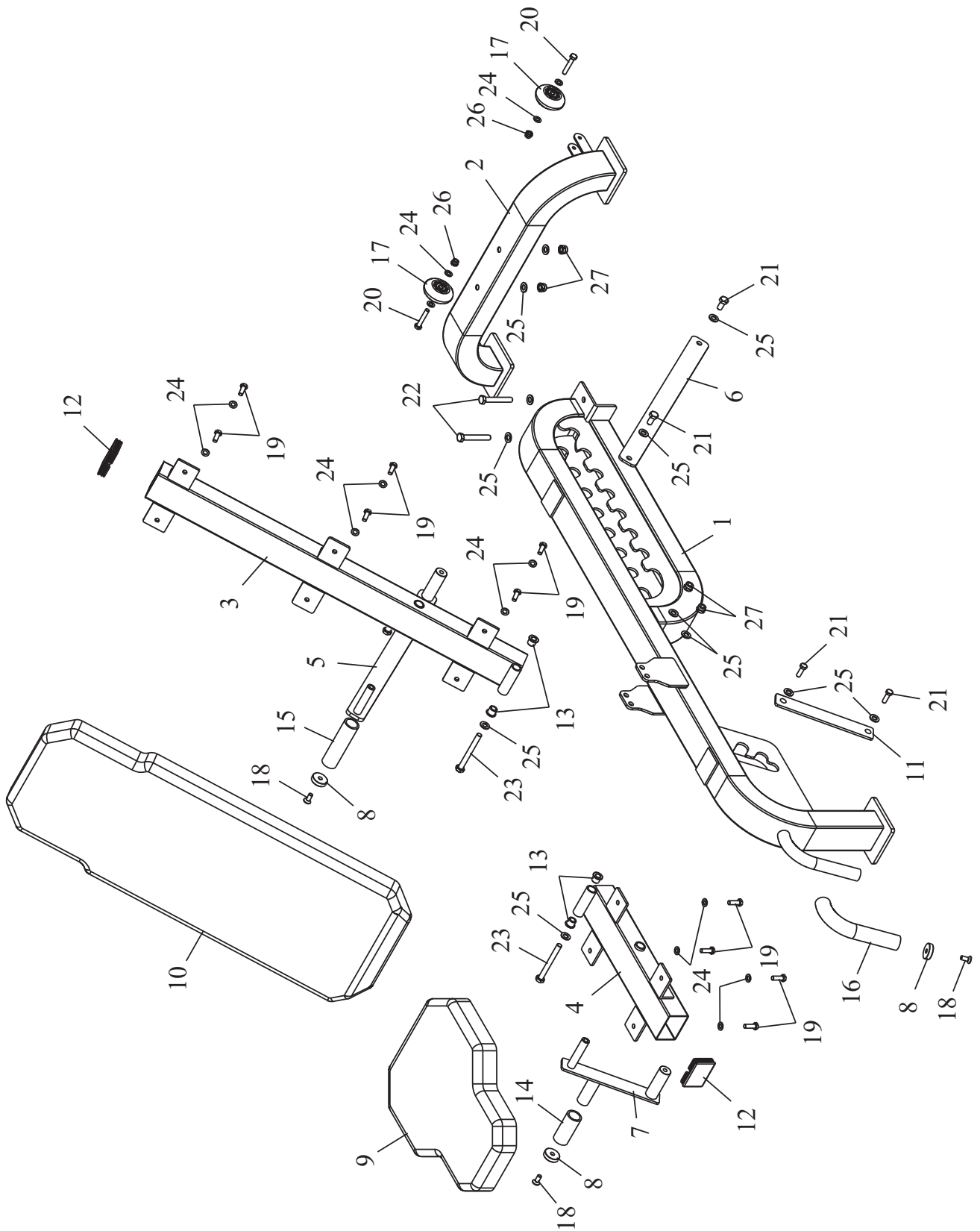



Products from TAURUS® are subject to strict quality control. However, if a fitness equipment purchased from us does not work perfectly, we take it very seriously and ask you to contact our customer service as indicated. We are happy to help you by phone via our service hotline.

### **Error Descriptions**

Your fitness equipment is developed for long-term, high-quality training. However, should a problem arise, please first read the operating instructions. For further assistance, please contact your contract partner or call our service hotline. To ensure your problem is solved as quickly as possible, please describe the defect as exactly as possible.

In addition to the statutory warranty, we provide a warranty for every fitness equipment purchased from us according to the following provisions.

**Your statutory rights are not affected.**

### **Warranty**

The warranty is the first/original buyer.

### **Warranty periods**

The following warranty periods begin on delivery of the fitness equipment.

#### **Warranty period**

The warranty periods, shown on our web shop, begin on delivery of the fitness equipment. The respective warranty periods for your equipment can be found on its product website.

### **Repair Costs**

According to our choice, there will either be a repair, a replacement of individual damaged parts or a complete replacement. Spare parts, that have to be mounted while assembling the equipment, have to be replaced by the warranty holder personally and are not a part of repair. After the expiration of the warranty period, the responsibility for parts costs, repair costs, installation costs and delivery costs lies with the warranty holder.

### **The terms of use are defined as follows:**

- + Home use: solely for private use in private households up to 3 hours per day
- + Semi-professional use: up to 6 hours per day (e. g. rehabilitation centres, hotels, clubs, company gyms)
- + Professional use: more than 6 hours per day (e. g. commercial gyms)

## **Warranty Service**

Within the warranty period, equipment which develops faults as a result of material or manufacturing defects, will be repaired or replaced at our discretion. Ownership of equipment or parts of equipment which have been replaced is transferred to us. The warranty period is not extended nor does a new warranty period begin following repair or replacement under the warranty.

## **Warranty Conditions**

For the warranty to be valid, the following steps must be taken:

Please contact our customer service by email or phone. If the product under warranty has to be sent in for repair, the seller bears costs. After expiry of the warranty, the buyer bears the costs of transport and insurance. If the fault is covered by our warranty, you will receive a new or repaired equipment in return.

## **Warranty claims are invalid in case of damage resulting from:**

- + misuse or improper handling
- + environmental influences (moisture, heat, electrical surge, dust, etc.)
- + failure to follow the current safety measures for the equipment
- + failure to follow the operating instructions
- + use of force (e. g. hitting, kicking, falling)
- + interventions which were not carried out by one of our authorized service centres
- + unauthorised repair attempts

## **Proof of Purchase and Serial Number**

Please make sure that you are able to provide the appropriate receipt when claiming on your warranty. So that we can clearly identify the model of your equipment, and for the purposes of our quality control, you will need to give the serial number of your equipment, when contacting the service team. Where possible please have your serial number and your customer number ready when you call our service hotline. It will help us to deal with your request swiftly.







































If you cannot find the serial number on your fitness equipment, our service team is at your disposal to offer further information.

## **Service outside of the Warranty Period**

We are also happy to issue an individual cost estimate if there is a problem with your fitness equipment after the warranty has expired, or in cases which do not fall under the terms of the warranty, e. g. normal wear and tear. Please contact our customer service team to find a quick and cost-effective solution to your problem. In such a case you will be responsible for the delivery costs.

## **Communication**

Many problems can be solved just by speaking to us as your specialist supplier. We know how important it is to you as a user of the fitness equipment to have problems solved quickly and simply, so you can enjoy working out with minimal interruption. For that reason, we also want to resolve your queries quickly and in a straightforward manner. Thus, please always keep your customer number and the serial number of the faulty equipment handy.

DE	DK	UK
<p><b>TECHNIK</b></p> <p> +49 4621 4210-900</p> <p> +49 4621 4210-698</p> <p> technik@fitshop.de</p> <p> Öffnungszeiten entnehmen Sie unserer Homepage.</p> <p><b>SERVICE</b></p> <p> 0800 20 20277 (kostenlos)</p> <p> 04621 4210 - 0</p> <p> info@fitshop.de</p> <p> Öffnungszeiten entnehmen Sie unserer Homepage: <a href="https://stg.fit/statita">https://stg.fit/statita</a></p>	<p><b>TEKNIK OG SERVICE</b></p> <p> 80 90 16 50</p> <p>+49 4621 4210-945</p> <p> info@fitshop.dk</p> <p> Åbningstider kan findes på hjemmesiden: <a href="https://stg.fit/statit7">https://stg.fit/statit7</a></p> <p><b>FR</b></p> <p><b>TECHNIQUE &amp; SERVICE</b></p> <p> +33 (0) 189 530984</p> <p>+49 4621 42 10 933</p> <p> info@fitshop.fr</p> <p> Vous trouverez les heures d'ouverture sur notre site Internet: <a href="https://stg.fit/statit4">https://stg.fit/statit4</a></p>	<p><b>CUSTOMER CARE</b></p> <p> +44 141 737 2249 or +44 141 876 3972</p> <p> customercare@fitshop.co.uk</p> <p> You can find the opening hours on our homepage: <a href="https://stg.fit/statitd">https://stg.fit/statitd</a></p> <p><b>BE</b></p> <p><b>TECHNIQUE &amp; SERVICE</b></p> <p> 02 732 46 77</p> <p>+49 4621 4210 933</p> <p> info@fitshop.be</p> <p> Vous trouverez les heures d'ouverture sur notre site Internet: <a href="https://stg.fit/statit8">https://stg.fit/statit8</a></p>
ES	NL	INT
<p><b>TECNOLOGÍA Y SERVICIOS</b></p> <p> 911 238 029</p> <p> info@fitshop.es</p> <p> Consulta nuestro horario de apertura en la página web: <a href="https://stg.fit/statit5">https://stg.fit/statit5</a></p>	<p><b>TECHNISCHE DIENST &amp; SERVICE</b></p> <p> +31 172 619961</p> <p> service@fitshop.nl</p> <p> De openingstijden vindt u op onze homepage: <a href="https://stg.fit/statit3">https://stg.fit/statit3</a></p>	<p><b>TECHNICAL SUPPORT &amp; SERVICE</b></p> <p> +49 4621 4210-944</p> <p> service-int@fitshop.de</p> <p> You can find the opening hours on our homepage: <a href="https://stg.fit/statita">https://stg.fit/statita</a></p>
PL	AT	CH
<p><b>DZIAŁ TECHNICZNY I SERWIS</b></p> <p> 22 307 43 21</p> <p>+49 4621 42 10-948</p> <p> info@fitshop.pl</p> <p> Godziny otwarcia można znaleźć na stronie głównej: <a href="https://stg.fit/statit6">https://stg.fit/statit6</a></p>	<p><b>TECHNIK &amp; SERVICE</b></p> <p> 0800 20 20277 (Freecall)</p> <p>+49 4621 42 10-0</p> <p> info@fitshop.at</p> <p> Öffnungszeiten entnehmen Sie unserer Homepage: <a href="https://stg.fit/statitb">https://stg.fit/statitb</a></p>	<p><b>TECHNIK &amp; SERVICE</b></p> <p> 0800 202 027</p> <p>+49 4621 42 10-0</p> <p> info@fitshop.ch</p> <p> Öffnungszeiten entnehmen Sie unserer Homepage: <a href="https://stg.fit/statit9">https://stg.fit/statit9</a></p>

Please find a detailed overview including address and opening hours for all stores of Fitshop UK on the following website:

[www.fitshop.co.uk/storelocator](http://www.fitshop.co.uk/storelocator)

# WE LIVE FITNESS

## WEBSHOP AND SOCIAL MEDIA

The Fitshop Group is Europe's largest specialist for home fitness equipment with currently 70 stores and one of the world's most renowned online mail order companies for fitness equipment.

Fitshop UK is part of the Fitshop Group. Private customers order via the 25 web shops in the respective national language or have their desired equipment assembled on site. In addition, the company supplies fitness studios, hotels, sports clubs, companies and physio practices with professional equipment for endurance and strength training.

The Fitshop group offers a wide range of fitness equipment from renowned manufacturers, high-quality in-house developments and comprehensive services, such as a build-up service and sports scientific advice before and after the purchase. The company employs numerous sports scientists, fitness trainers and competitive athletes.

Visit us also on our social media platforms or our blog!



<https://www.fitshop.co.uk/>  
[www.fitshop.co.uk/blog/](https://www.fitshop.co.uk/blog/)



[www.facebook.com/fitshop.co.uk](https://www.facebook.com/fitshop.co.uk)



[www.instagram.com/fitshop\\_uk](https://www.instagram.com/fitshop_uk)



[www.youtube.com/@fitshop\\_uk](https://www.youtube.com/@fitshop_uk)

**TAURUS**

 cardiostrong

*BODYCRAFT*

**BodyMax**

Notes

Notes



**TAURUS®**