

TAURUS®

Assembly and Operating Instructions

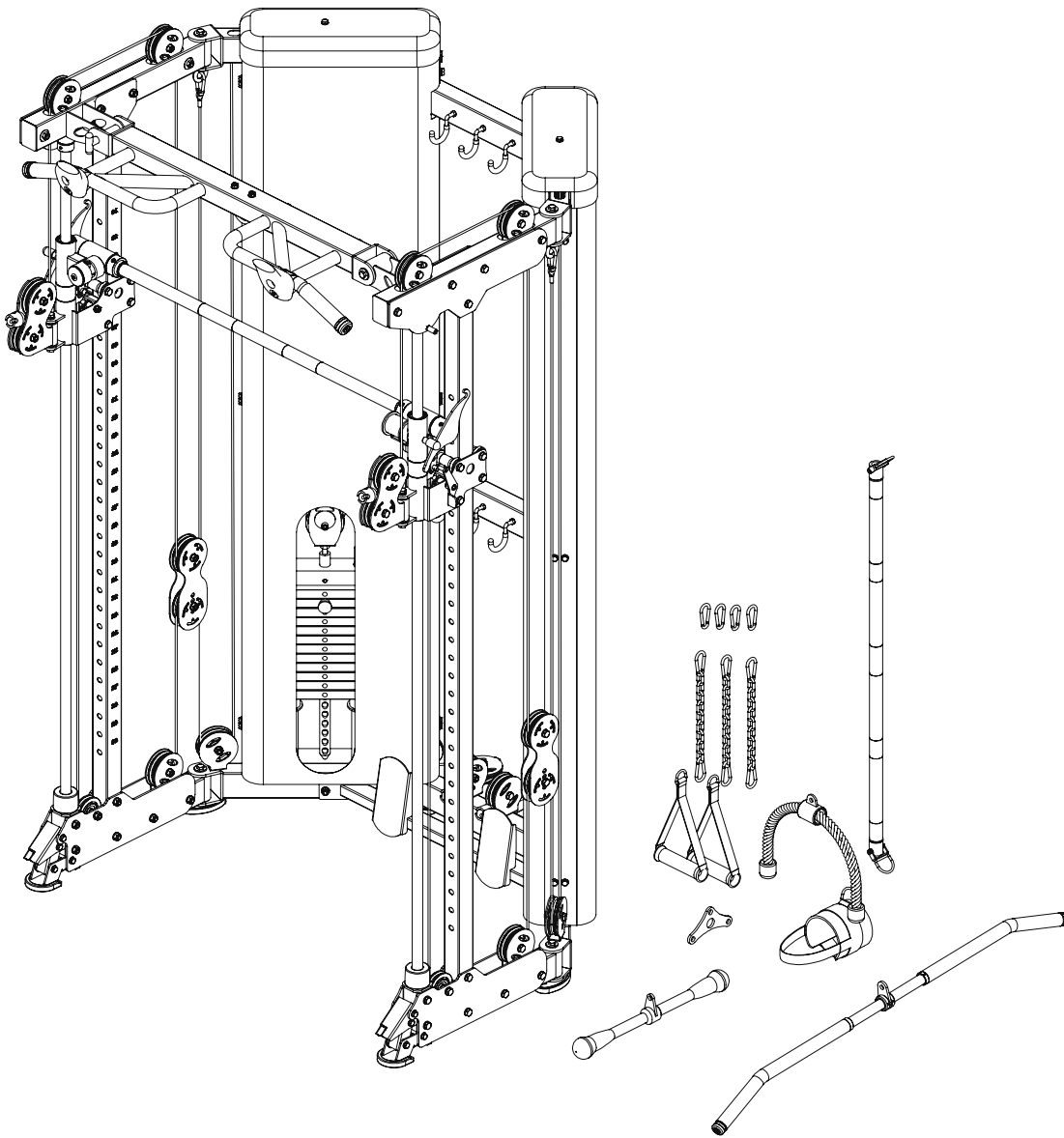

max. 150 kg



~ 240 Min.



220 kg

L 120 | W 125 | H 220

SKU: TF-MS40

FSUKTFMS40.01.01

Taurus MS40 Pro

Content

1	GENERAL INFORMATION	8
1.1	Technical Data	8
1.2	Personal Safety	9
1.3	Set-Up Place	10
2	ASSEMBLY	11
2.1	General Instructions	11
2.2	Scope of Delivery	12
2.3	Assembly	16
3	STORAGE AND TRANSPORT	37
3.1	General Instructions	37
4	TROUBLESHOOTING, CARE AND MAINTENANCE	38
4.1	General Instructions	38
4.2	Faults and Fault Diagnosis	38
4.3	Maintenance and Inspection Calendar	39
5	DISPOSAL	39
6	RECOMMENDED ACCESSORIES	40
7	ORDERING SPARE PARTS	41
7.1	Serial Number and Model Name	41
7.2	Parts List	42
7.3	Exploded Drawing	45
8	WARRANTY	46
9	CONTACT	48

Dear customer,

Thank you for choosing quality training equipment from the TAURUS brand. Taurus offers sports and fitness equipment for home users with high demands on quality, functionality and longevity. Also, Taurus is a well-known and experienced brand for equipping professional rooms for fitness studios and business customers. The focus of Taurus fitness equipment is on what matters most in sports: maximum performance! Therefore, the devices are developed in close consultation with athletes and sports scientists. Because athletes know best what makes perfect fitness equipment.

Further information can be found at www.fitshop.co.uk

Intended Use

The equipment may only be used for its intended purpose.

The equipment is suitable for home use and semi-professional use (e.g. hospitals, clubs, hotels, schools, etc.). The equipment is not suitable for commercial or professional use (e.g. fitness studio).

Legal Notice

Fitshop GmbH
Europe's No. 1 for home fitness

International Headquarters
Flensburger Straße 55
24837 Schleswig
Germany

Management:
Christian Grau
Sebastian Campmann
Dr. Bernhard Schenkel
No. HRB 1000 SL
Local Court Flensburg
European VAT Number: DE813211547

Disclaimer

© TAURUS is a registered brand of the company Fitshop GmbH. All rights reserved. Any use of this trademark without the explicit written permission of Fitshop is prohibited.

Product and manual are subject to change. Technical data can be changed without advance notice.

FITSHOP

Europe's No.1 for Home Fitness

ABOUT THIS MANUAL

Please carefully read the entire manual before installation and first use. The manual will help you to quickly set up the system and explains how to safely use it. Make sure that all persons exercising with the equipment (especially children and persons with physical, sensory, mental or motor disabilities) are informed about this manual and its contents in advance. In case of doubt, responsible persons must supervise the use of the equipment.

Due to ongoing changes and software optimisations, the manual may have to be updated. If you notice any discrepancies during assembly or use, please refer to the manual uploaded to the webshop. The latest manual is always available there.



This equipment has been manufactured according to the latest safety knowledge. As far as possible, potential safety hazards which could cause injury have been eliminated. Make sure to carefully follow the instructions and that all parts are securely in place. If required, read through the instructions again to correct any mistakes.

Training devices must be classified according to accuracy and use. Accuracy classes are only applicable to devices that display training data.

Accuracy classes

Class A: high accuracy.

Class B: medium accuracy.

Class C: low accuracy.

The use classes explain the intended use of the training device.

Use classes

Class S (studio): professional and/or commercial use.

These training devices are intended for the use in training rooms of facilities such as sports clubs, school facilities, hotels, clubs and studios whose access and supervision is specifically regulated by the owner (person with legal responsibility).

Class H (home use): use at home.

These stationary training devices are intended for the use in private homes where access to the training device is regulated by the owner (person with legal responsibility).

Please pay close attention to the safety and maintenance instructions given here. The contract partner cannot be held liable for damage to health, accidents or damage to the equipment when it is not used in accordance with these instructions.

The following safety instructions may appear in this manual:

► **ATTENTION**

This notice indicates potentially hazardous situations which, if not avoided, may result in property damage.

⚠ **CAUTION**

This notice indicates potentially hazardous situations which, if not avoided, may result in slight or minor injuries!

⚠ **WARNING**

This notice indicates potentially hazardous situations which, if not avoided, may result in death or serious injuries!

⚠ **DANGER**

This notice indicates potentially hazardous situations which, if not avoided, will result in death or serious injuries!

ⓘ **NOTICE**

This notice indicates further useful information.

Retain these instructions in a safe place for future reference, maintenance or when ordering replacement parts.

1.1 Technical Data

Weight and Dimensions:

Packaging dimensions (L x W x H) and article weight (gross, incl. packaging) approx.:

226 cm x 77 cm x 34 cm
235 kg

Article weight (net, without packaging):

220 kg

Set up dimensions (L x W x H) approx.:

120 cm x 125 cm x 220 cm

Folding dimensions (L x W x H) approx.:

120 cm x 60 cm x 220 cm

Quantity of weight stacks:

2

Total weight:

90 kg per weight stack

Cable length:

1023.5 cm, 411.5 cm

Cable material:

Steel

Cover material:

Nylon

Transmission ratio:

1:2

Maximum user weight:

150

Use class:

S

1.2 Personal Safety

DANGER

- + Before you start using the equipment, you should consult your physician that this type of exercise is suitable for you from a health perspective. Particularly affected are persons who: have a hereditary disposition to high blood pressure or heart disease, are over the age of 45, smoke, have high cholesterol values, are overweight and/or have not exercised regularly in the past year. If you are under medical treatment that affects your heart rate, medical advice is absolutely essential.
- + Note that excessive training can seriously endanger your health. Please also note that heart rate monitoring systems can be inaccurate. If you notice any signs of weakness, nausea, dizziness, pain, shortness of breath, or other abnormal symptoms, stop exercising immediately and seek advice from your doctor if necessary.
- + The owner must communicate all warnings and instructions to the user.

WARNING

- + This equipment may not be used by children under the age of 14.
- + Children should not be allowed unsupervised access to the equipment.
- + Persons with disabilities must have a medical license and must be under strict observation when using the equipment.
- + The equipment is strictly for use by one person at a time.
- + Keep your hands, feet and other body parts, hair, clothing, jewellery and other objects well clear of moving parts.
- + During use, wear suitable sports clothing rather than loose or baggy clothing. When wearing sports shoes, make sure they have suitable soles, preferably made of rubber or other non-slip materials. Shoes with heels, leather soles, studs or spikes are unsuitable. Never exercise barefoot.
- + Always start each workout with a light warm-up and end with a cool-down phase.
- + Using the machine as a support during stretching exercises or attaching resistance bands, ropes or other accessories to it, may cause injuries.

CAUTION

- + If your equipment needs to be connected to the power supply with a mains cable, make sure that the cable is not a potential tripping hazard.
- + Make sure that nobody is within the range of motion of the equipment during training so as not to endanger you or other persons.
- + Be aware that if adjustment devices are left protruding, they may impede the user's movement.

ATTENTION

- + Do not insert any objects of any kind into the openings of the device.

1.3 Set-Up Place

WARNING

- + Do not place the equipment in main corridors or escape routes.

CAUTION

- + Choose a location in which to place the equipment such that there is enough free space/clearance to the front, the rear and to the sides of the equipment.
- + The training room should be well ventilated during training and not be exposed to any draughts.
- + Choose the place in which to set up the equipment such that there is enough free space/clearance to the front, the rear and to the sides of the equipment.
- + The free area in the direction from which the exercise equipment is accessed must be at least 0.6 m larger than the exercise area.
- + The set-up and mounting surface of the equipment should be flat, loadable and solid.
- + If your device is to be mounted on the wall/ceiling, make sure that you use the appropriate assembly material to avoid possible damages or personal injuries. The contractual partner accepts no liability for this.

ATTENTION

- + The device may only be used in one building, in sufficiently tempered and dry rooms (ambient temperatures between 10°C and 35°C). The equipment should not be used outdoors or in rooms with high humidity (over 70%) like swimming pools.
- + A floor protective mat/equipment underlay can help to protect high-quality floor coverings (parquet, laminate, cork, carpets) from dents and sweat and can help to level out slight unevenness.
- + For Class S equipment, the exercise equipment may only be used in areas where access, supervision and control are specifically regulated by the owner.

2.1 General Instructions

DANGER

- + Do not leave any tools, packaging materials such as foils or small parts lying around, as otherwise there is a danger of suffocation for children. Keep children away from the equipment during assembly.

WARNING

- + Pay attention to the instructions attached to the equipment in order to reduce the risk of injuries.

CAUTION

- + Ensure to have sufficient room for movement in each direction during assembly.
- + The assembly of the equipment must be carried out by at least two adults. If in doubt, seek the help of a third technically skilled person.

ATTENTION

- + To prevent damage to the equipment and the floor, assemble the equipment on a mat or packaging board.

NOTICE





- + In order to make the assembly as simple as possible, some screws and nuts to be used can already be pre-assembled.
- + Ideally, assemble the equipment at its later set-up place.





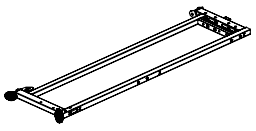
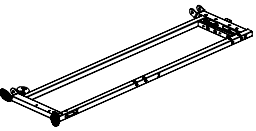
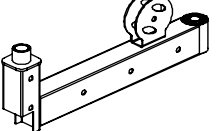
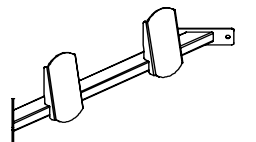
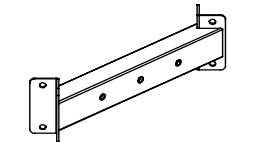
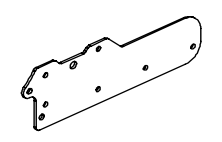
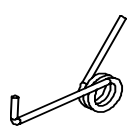
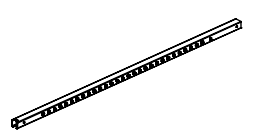
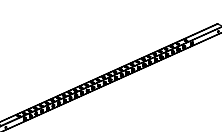
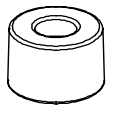
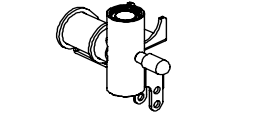
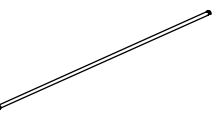
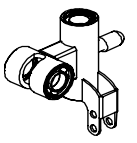

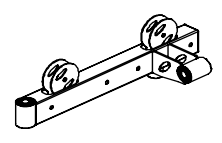
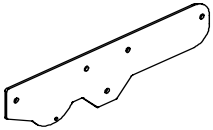
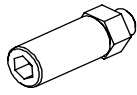
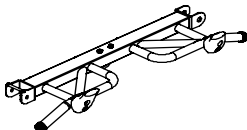
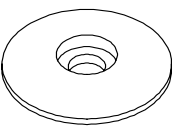
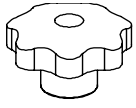
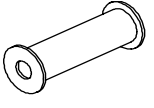
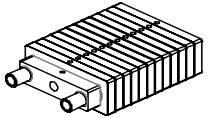
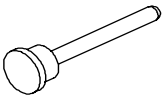

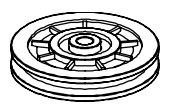
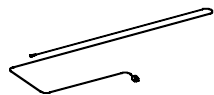
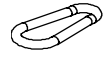
2.2 Scope of Delivery

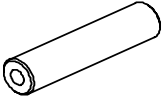
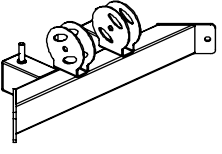
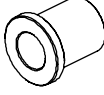
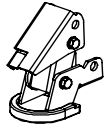
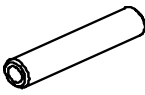
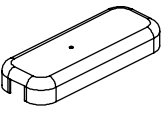
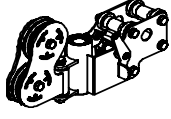
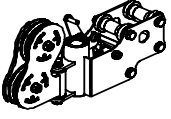
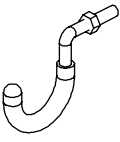

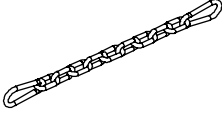
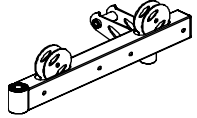

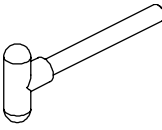
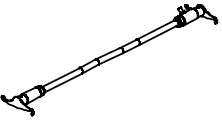
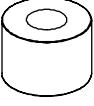

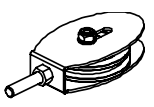
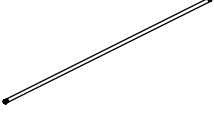
The scope of delivery consist of the following parts. At the beginning, check whether all parts and tools belonging to the device are included in the scope of delivery and whether damage has occurred. In the event of complaints, the contractual partner must be contacted directly.

 **CAUTION**

If parts of the scope of delivery are missing or damaged, the assembly must not be carried out.

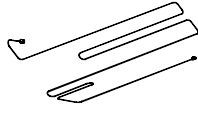
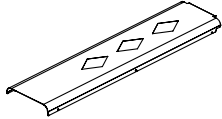
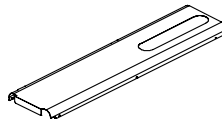
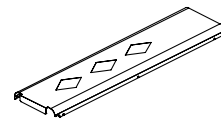
	Q'TY		Q'TY		Q'TY
1.Upright Frame-Right	1	2.Upright Frame-Left	1	3.Down Side Link Tube	2
					
15.Leg Press	1	10.Middle Link Tube	2	17.Down Fixing Plate	4
					
80.Spring	2	21.Front Standing Tube-Left	1	18.Front Standing Tube-Right	1
					
26.Rubber Block	2	27.Sliding Sleeve-Right	1	28.Guide Rod	2
					
32.Sliding Sleeve-Left	1	39.Ring	2	36.Up Side Link Tube	1
					
35.Up Fixing Plate	2	33.Thread Pin	2	34.Chin Up Frame	1
					
43.Aluminum Cap	1	45.Locking Spring Knob	1	46.Weight Support Tube	4
					
49.Weight Plate	2	50.Magnetic Pin	2	51.Open Hollow Pin	2
					
55.Pulley	12	62.Cable	2	63.Carabiner	6

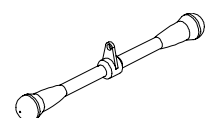
	Q'TY		Q'TY		Q'TY
6.Internal Thread Axle	5	9.Down Back Link Tube	1	59.Powder Metallurgy	4
					
19.Feet Cover	2	20.Internal Thread Axle	4	66.Top Cover	2
					
22.Sliding Frame-Right	1	23.Sliding Frame-Left	1	71.Hook	6
					
29.Rubber Block	2	30.Lock Sleeve	2	76.Carabiner And Chain	3
					
37.Up Side Link Tube-Left	1	38.Back Fixing Plate	2	40.T Shape Pin	1
					
41.Barbell Bar	1	47.Rubber Block	4	48.Selector Rod	2
					
52.Pulley Holder	2	53.Stainless Steel Rod	4	61.Rotating Pulley Holder	2
					
57.Powder Metallurgy	20				

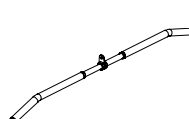
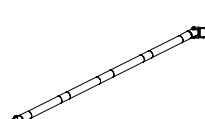
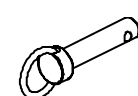
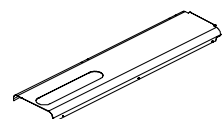
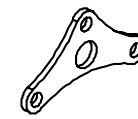
	Q'TY		Q'TY		Q'TY
60. Pulley	12	56. Pulley Cover	2	64. Weight Cable	2
					
70. Outer Shield-Left	1	69. Inner Shield-Left	1	68. Outer Shield-Right	1
					
72. Plastic Handle	2	73. Triceps Rope	1	74. Short Straight Bar	1
					
77. Ankle Cuff	1	78. Lat Pull-Down Bar	1	79. Long Straight Bar	1
	Q'TY				
65. Ring Pull Pin	2	67. Inner Shield-Right	1	75. Triangle Plate	1

2.3 Assembly

Before assembly, take a close look at the individual assembly steps shown and carry out the assembly in the order given.

① NOTICE

- + First loosely screw all parts together and check that they fit properly. Tighten the screws using the tool only when you are instructed to do so.
- + If you have difficulty recognising the graphics, we recommend that you open and/or download the PDF instructions stored in the webshop on your end device (e.g. smartphone, tablet or PC). There you have the option of zooming in closer. Please note that the Adobe Acrobat Reader programme must be installed on your end device in order to open the file.

Step 1: Assembly of the Base Frame

Assemble the two parts of the lower link tube (3) with the right and left upright frames (1 & 2) using a total of two bolts (4) from above, two washers (5) from above, one axle (6), two washers (8) from below and two bolts (7) from below.

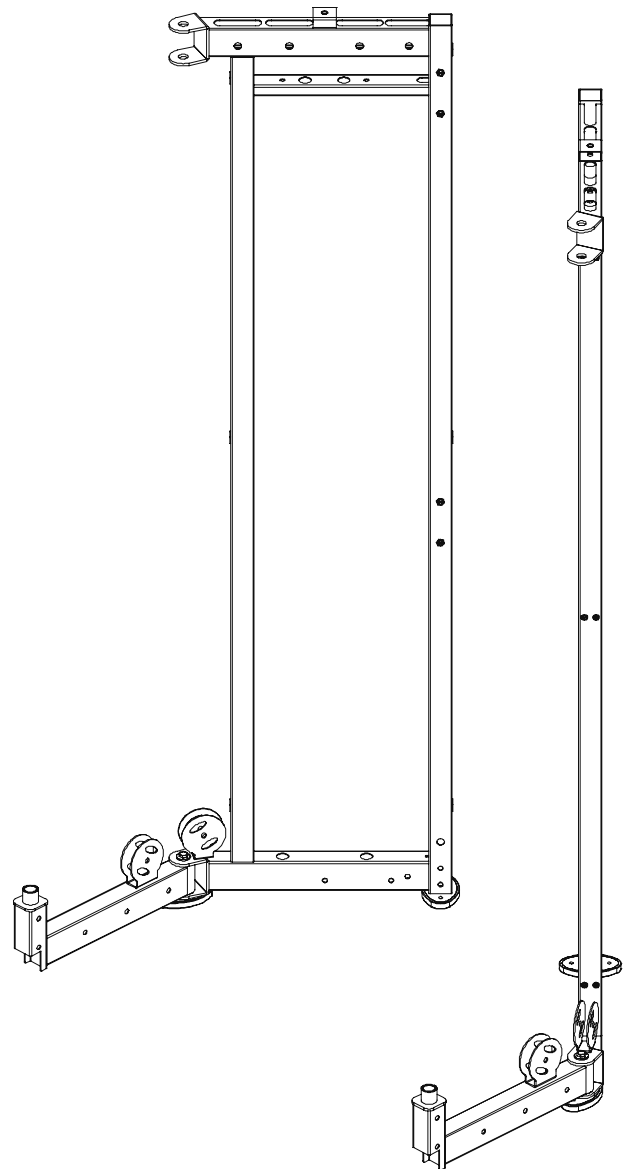

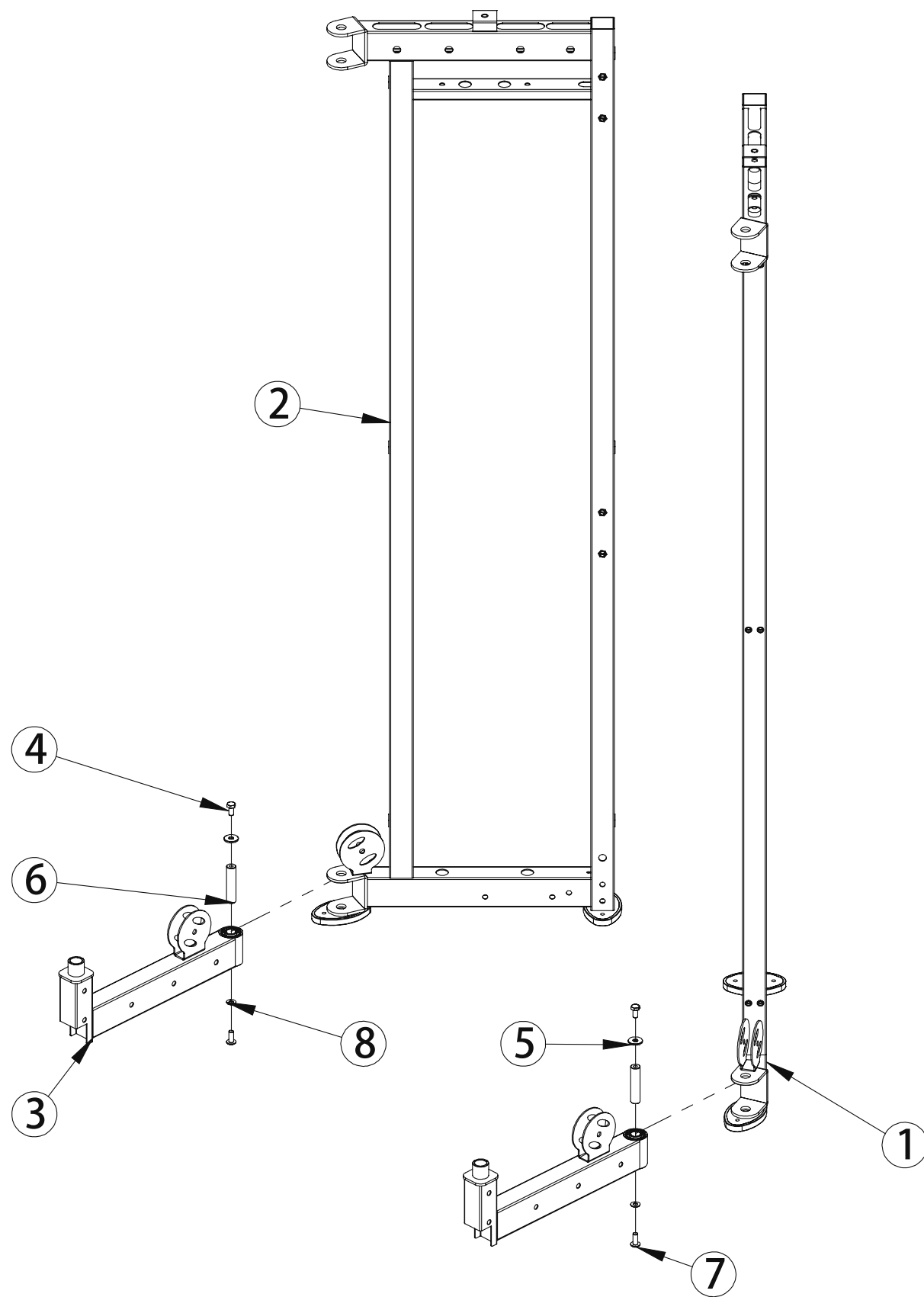

Step 2: Assembly of the Connection Frame

1. Attach the lower link tube (9) to the right and left upright frames (1 & 2) using three bolts (11), three washers (5) from the outside, one washer (8) from the inside and one nut (12).
2. Attach the leg press (15) to the right and left upright frames (1 & 2) using two bolts (11), two washers (5) from the rear, two washers (8) from the front and two nuts (12).
3. Mount the two link tubes (10) in the middle and at the top between the right and left upright frames (1 & 2) using four bolts (14), four washers (13), four washers (8) and four nuts (12).

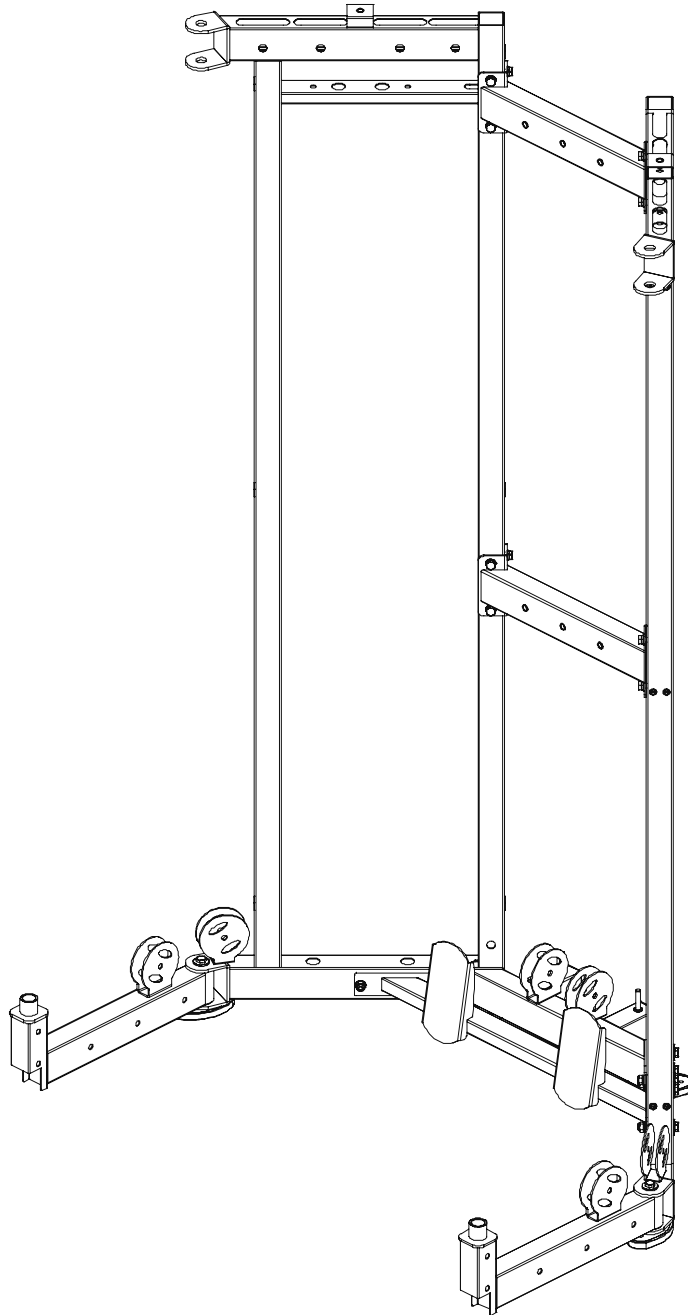

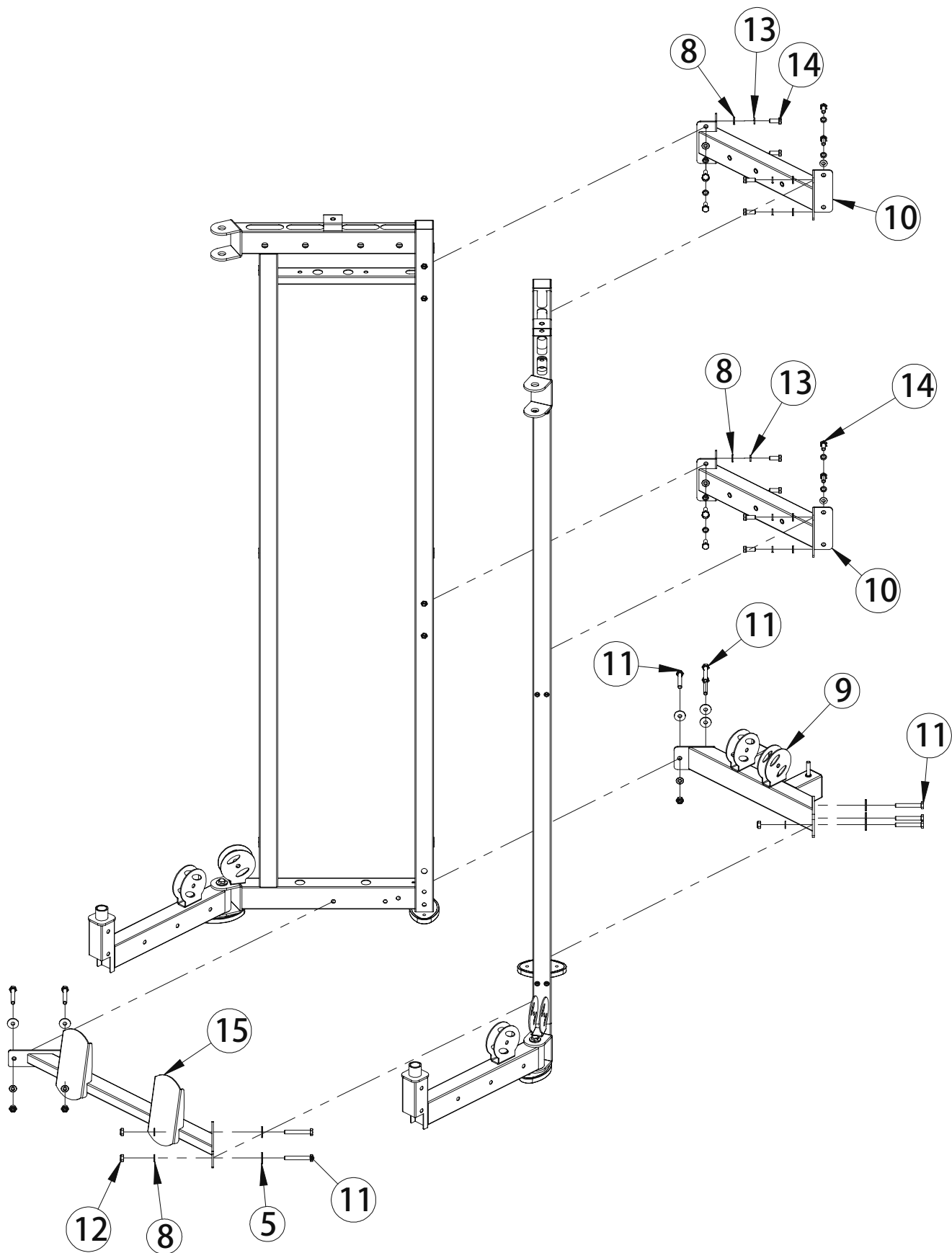

Step 3.1: Assembly of the Guide Rods

1. Fit the right and left front standing tubes (18 & 21) together with the two lower fixing plates (17) to the two lower link tubes (3) using six bolts (16), 12 washers (8) and six nuts (12).
2. Insert the guide rods (28) into the mounts provided on the lower link tubes (3).
3. Slide the parts onto the guide rods (28) in the following order:
 - + Rubber block (26)
 - + Sliding frames (22 & 23) - the adjusting units must be pushed onto both the guide rods (28) and the front standing tubes (18 & 21)
 - + Rubber block (29)
 - + Sliding sleeves (27 & 32)
 - + Lock sleeve (30)
 - + Bolt (31)

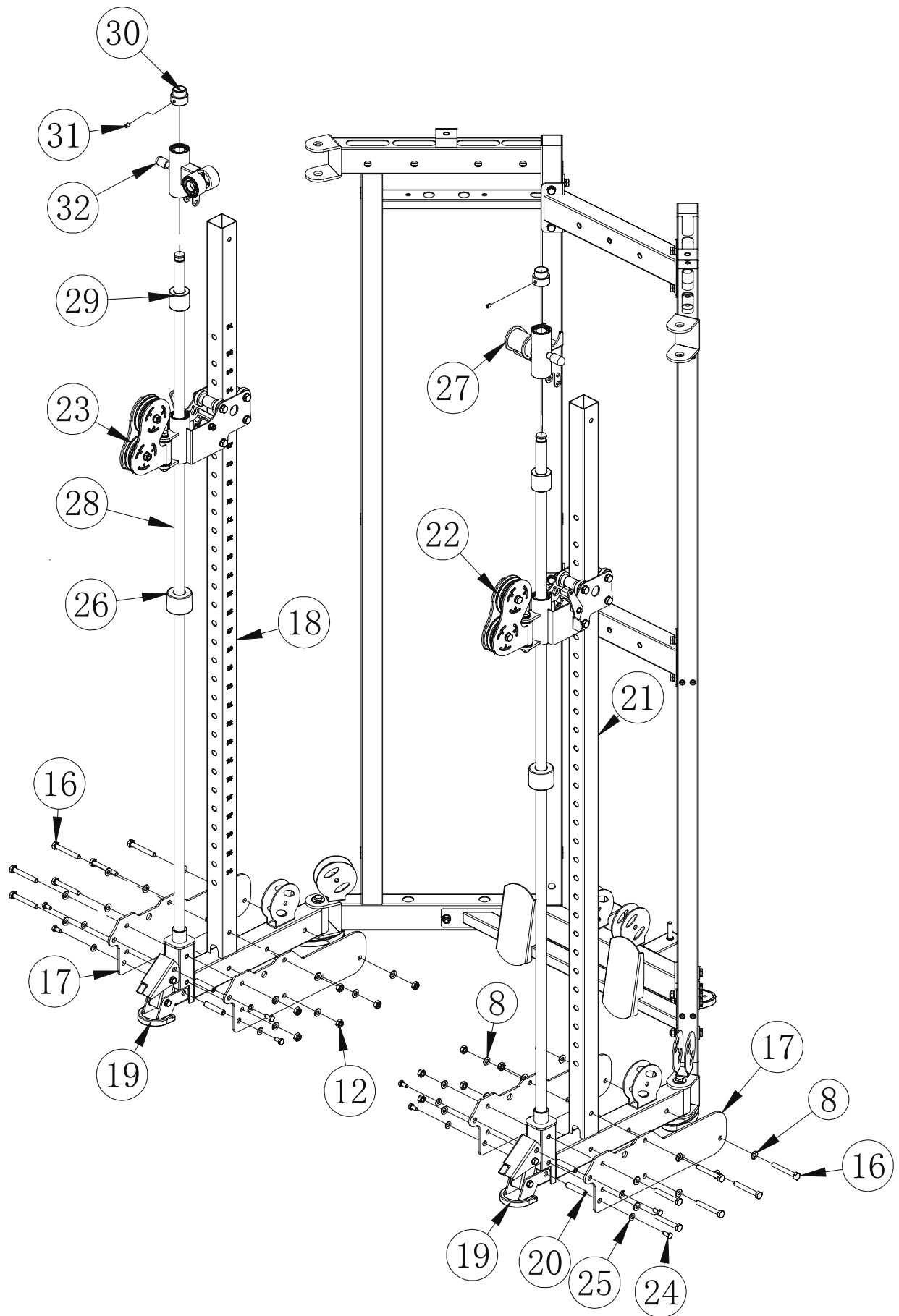

Step 3.2

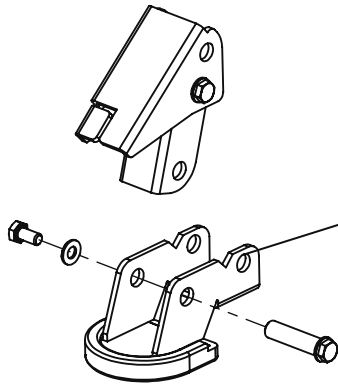

Step 3.2.1

Remove the feet cover (19).

Step 3.2.2

Guide the axle (20) through the spring (80) and the feet cover (19). Fasten the axle including the feet cover to the appliance using two bolts (24) and two washers (25).

► **ATTENTION**

Do not tighten the bolts yet.

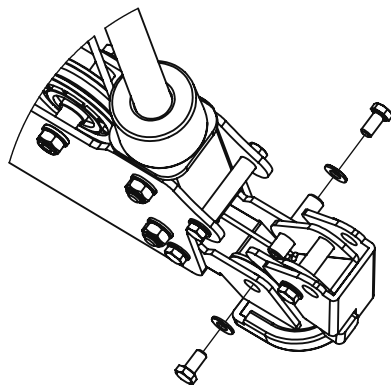
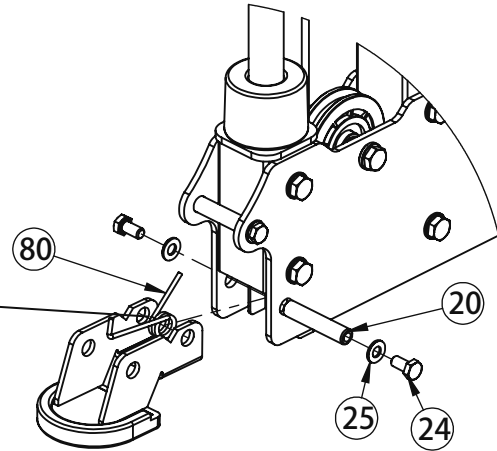

Step 3.2.3

Make sure that the spring (80) is located under the two axes shown in the illustration. Only now tighten the bolts firmly.

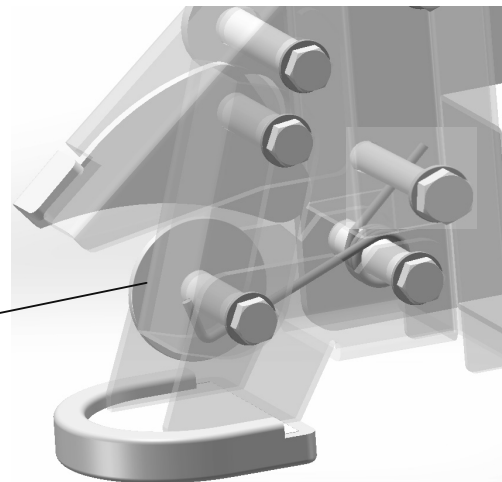

Step 3.2.4

Attach the feet cover (19) to the two fixing plates (17) using the axle (20), two bolts (24) and two washers (25)

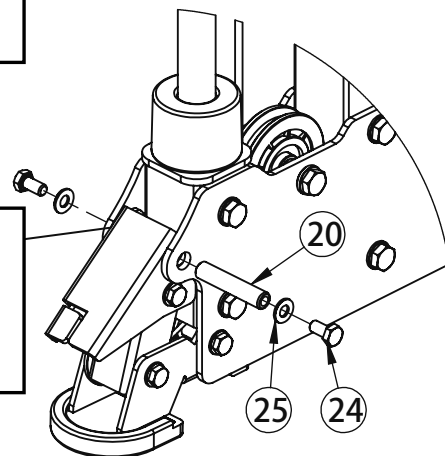

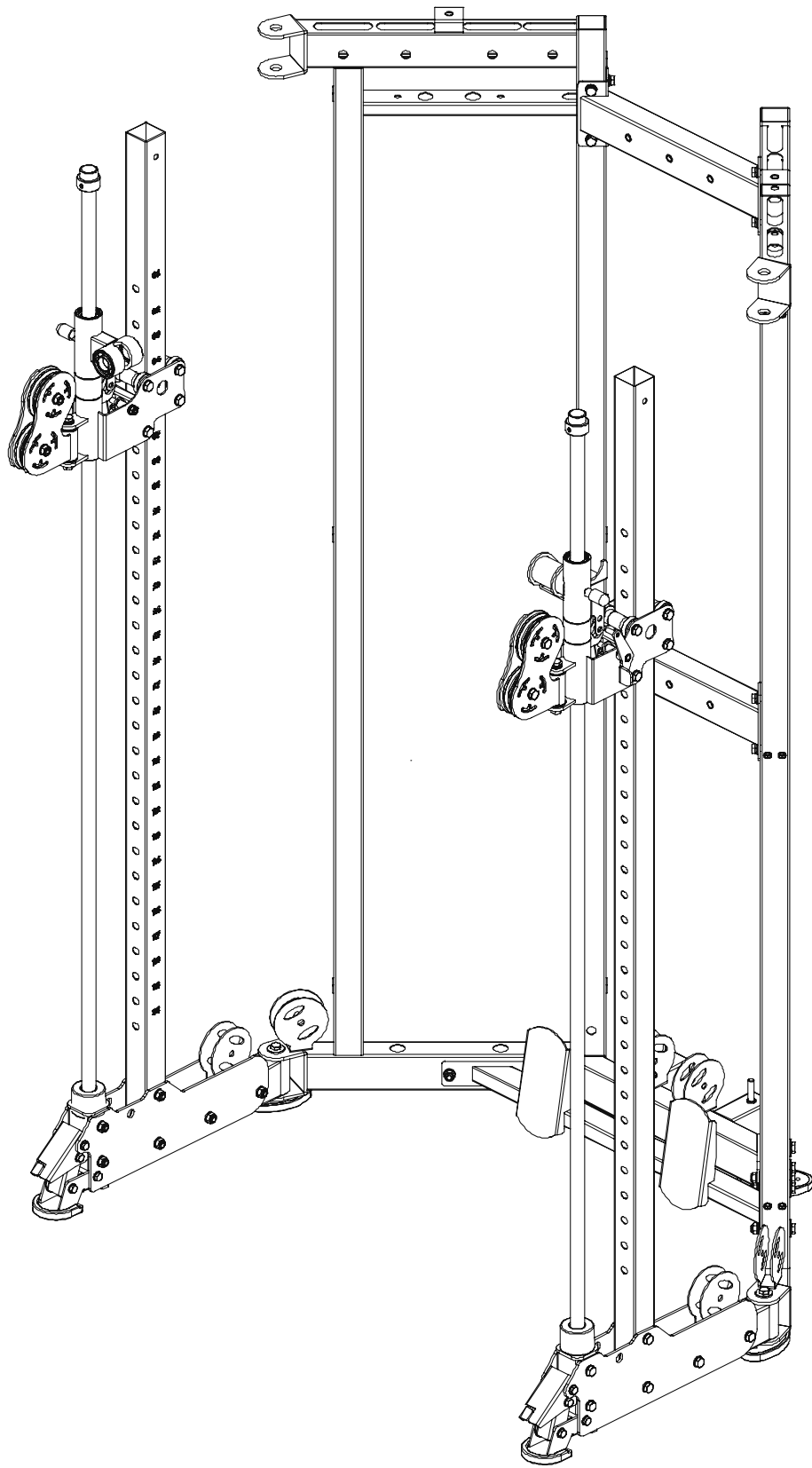

Step 4: Assembly of the Pull-Up Bar

1. Fit the upper fixing plates (35) and the connecting plate (38) to the side link tube (36) using three bolts (16), two bolts (11), one thread pin (33), eight washers (8), two washers (5) and five nuts (12).
2. Fit the upper fixing plates (35) and the fixing plate (38) to the side link tube (37) using three bolts (16), two bolts (11), one bolt (33), eight washers (8), two washers (5) and five nuts (12).
3. Fit the side link tube (36) to the right-hand side frame (1) using a bolt (4), two washers (5), an axle (6) and a cable ring (39).
4. Fit the side link tube (37) to the left-hand side frame (2) using a bolt (4), two washers (5), an axle (6) and a ring (39).
5. Fit the pull-up bar (34) to the side link tube (36) using a bolt (4), a washer (5), an axle (6) and lock the pull-up bar (34) to the side link tube (37) using a pin (40).

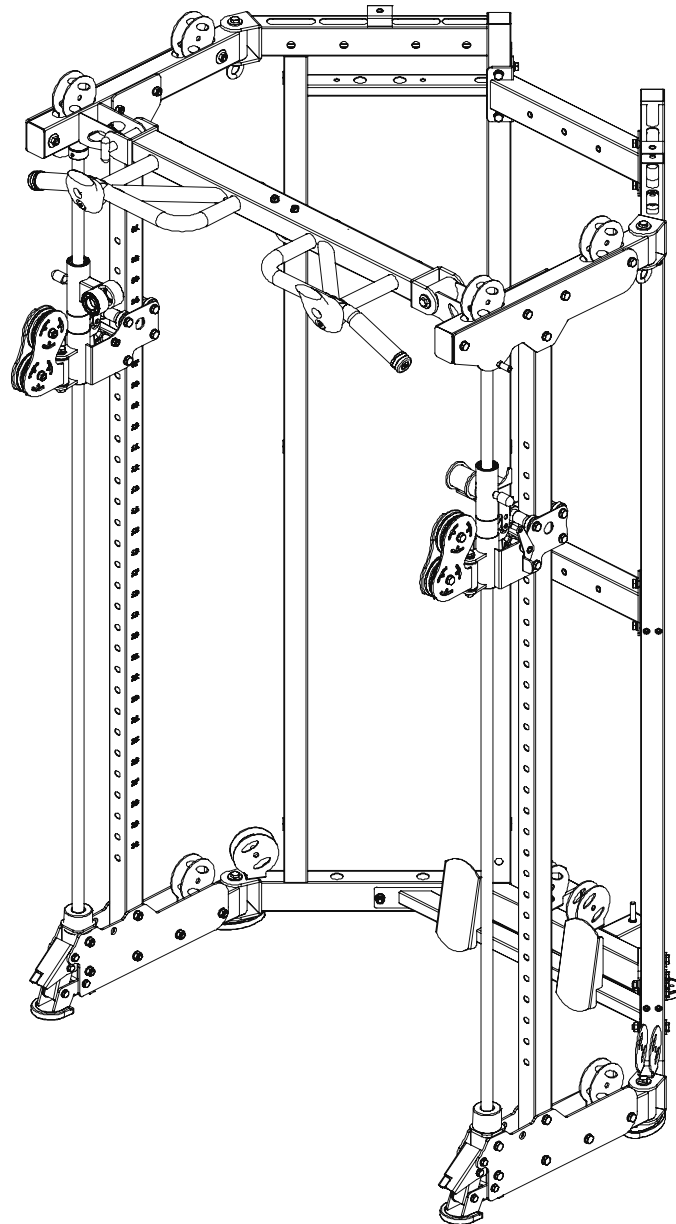

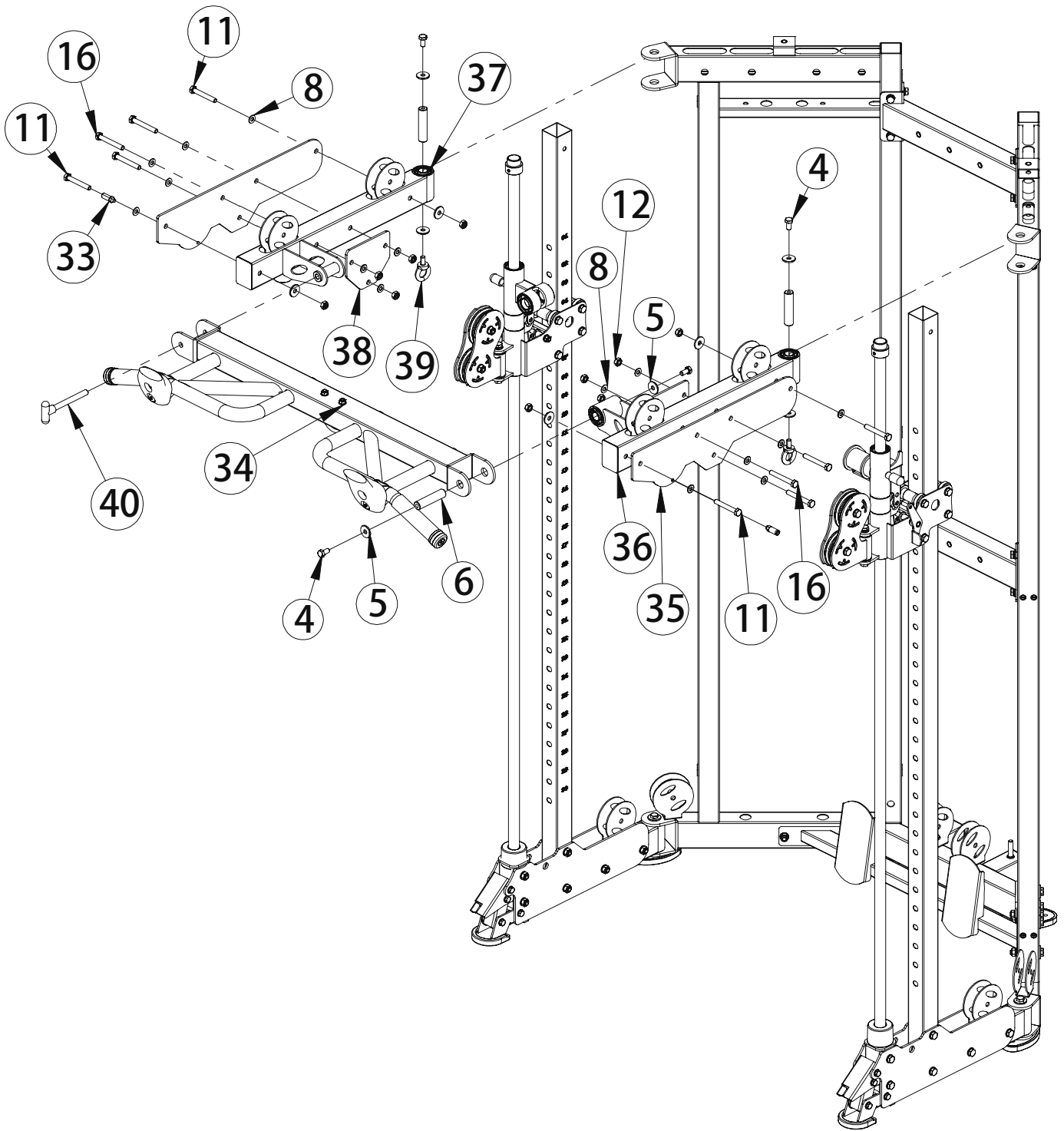

Step 5: Assembly of the Barbell Bar

1. Fit the barbell bar (41) to the actuator unit using a bolt (7), a spring washer (13) and a cap (43).
2. Fasten a bolt (44) to the barbell bar (41).
3. Fasten the barbell bar (41) to the other adjustment unit with a knob (45).

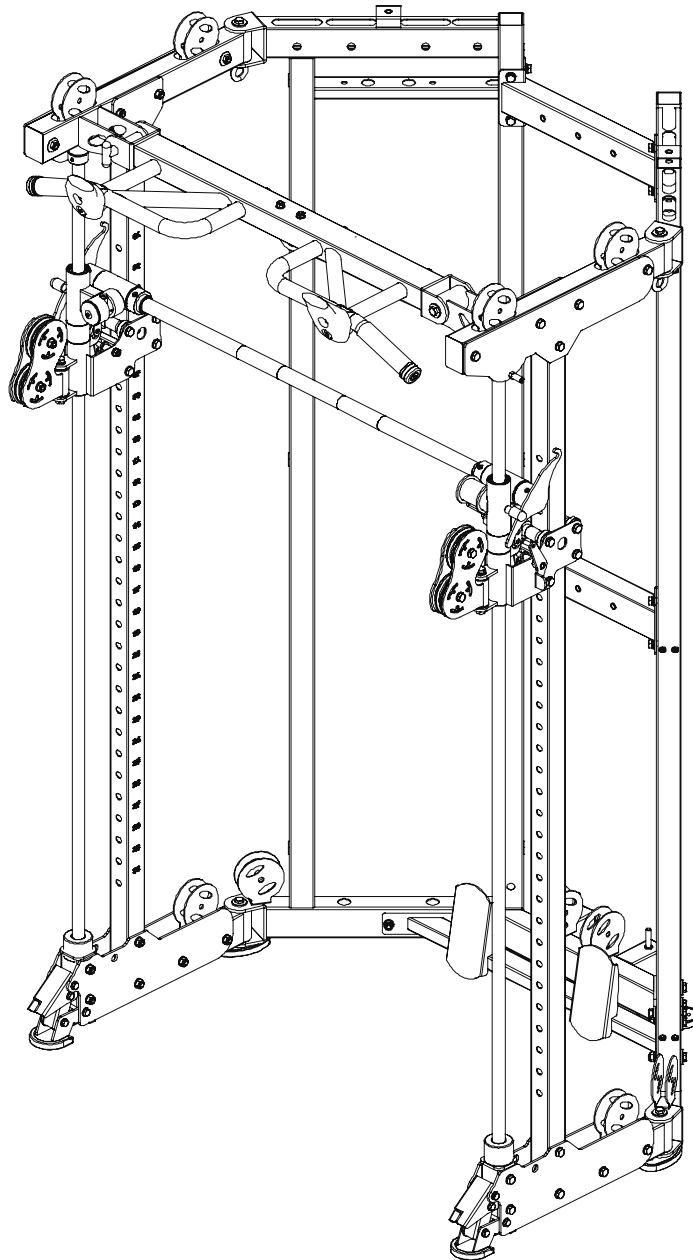

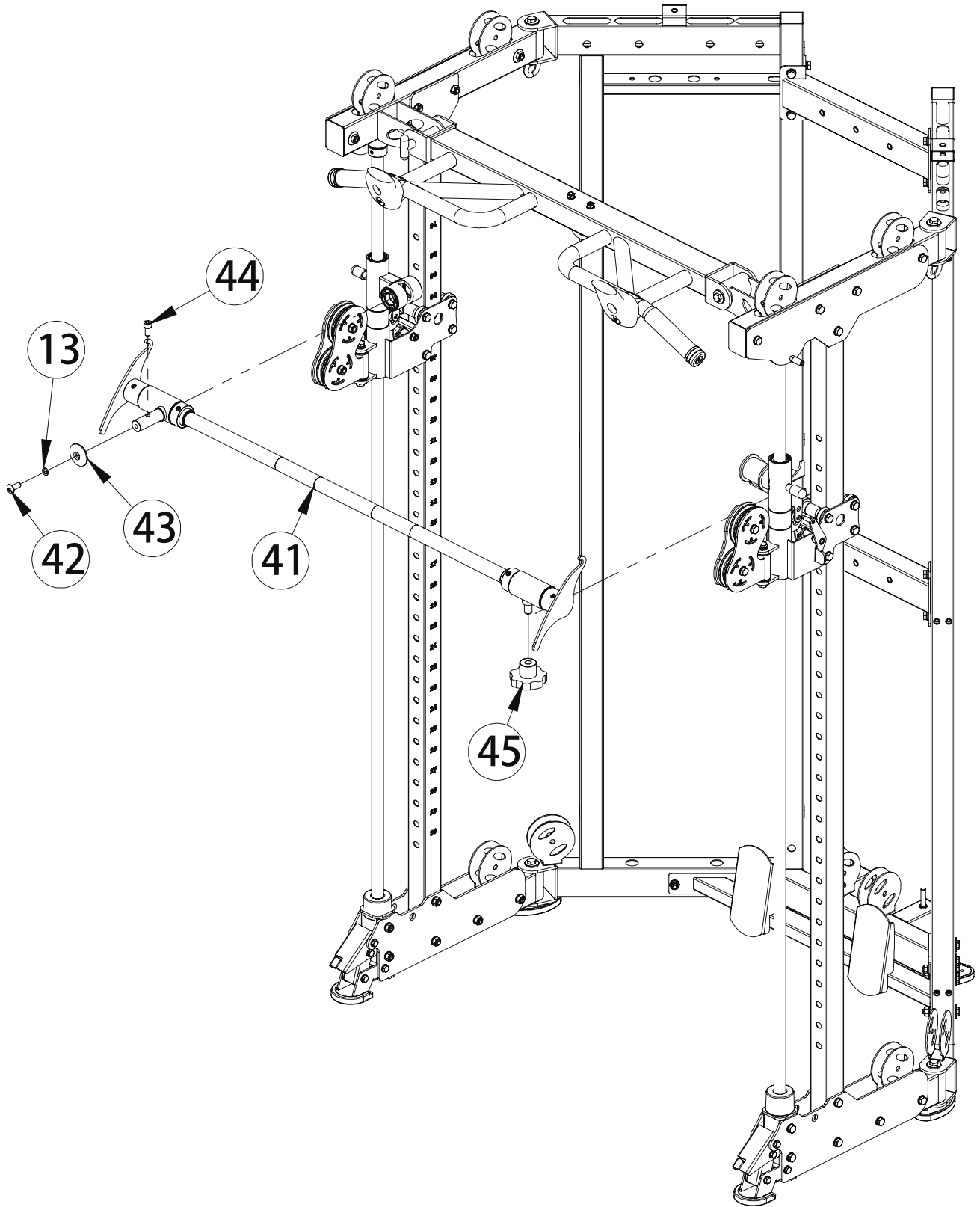

Step 6: Assembly of the Weight Blocks

1. Insert the guide rods (53) on the underside of the upright frame (1).

ⓘ **NOTICE**

The spacers (46) do not need to be fitted if you have the large weight block.

2. Slide the two support tubes (46) and the rubber blocks (47) onto the guide rods (53).
3. Slide the weight plates (49) individually onto the guide rods (53).
4. Fit the guide rods (53) to the top of the upright frame (1) using two bolts (54) and two washers (8).
5. Slide the selector rod (48) into the weight plates (49).
6. Attach the pulley holder (52) to the selector rod (48).
7. Drive the pin (51) into the slot provided on the top weight plate.
8. Insert the pin (50) into any hole in the selector rod (48).
9. Repeat these steps for the left-hand side.

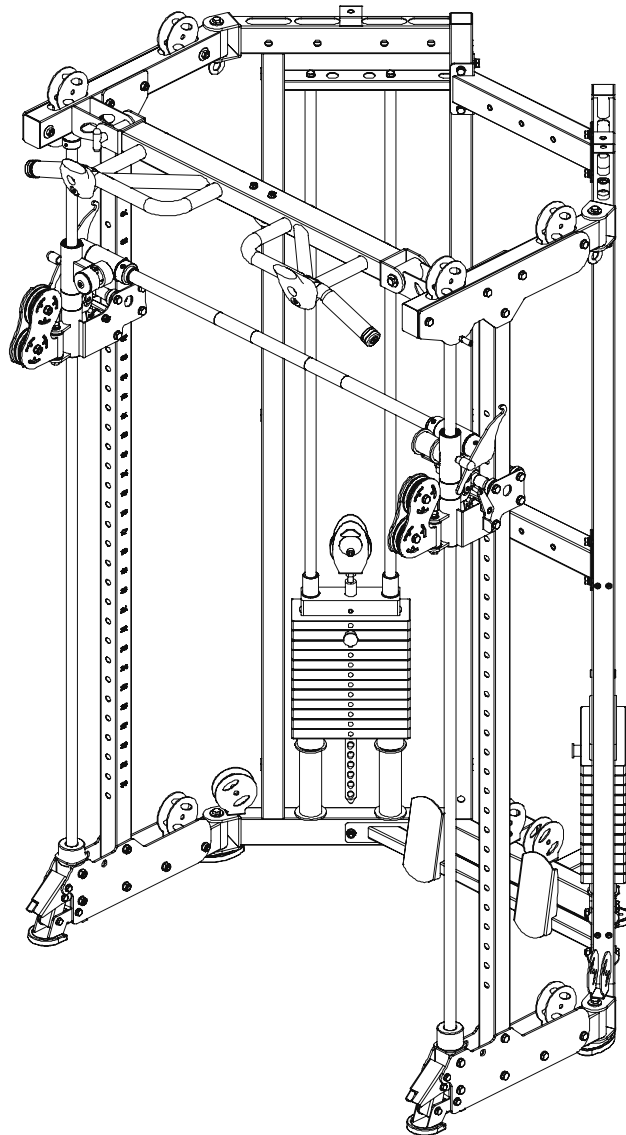

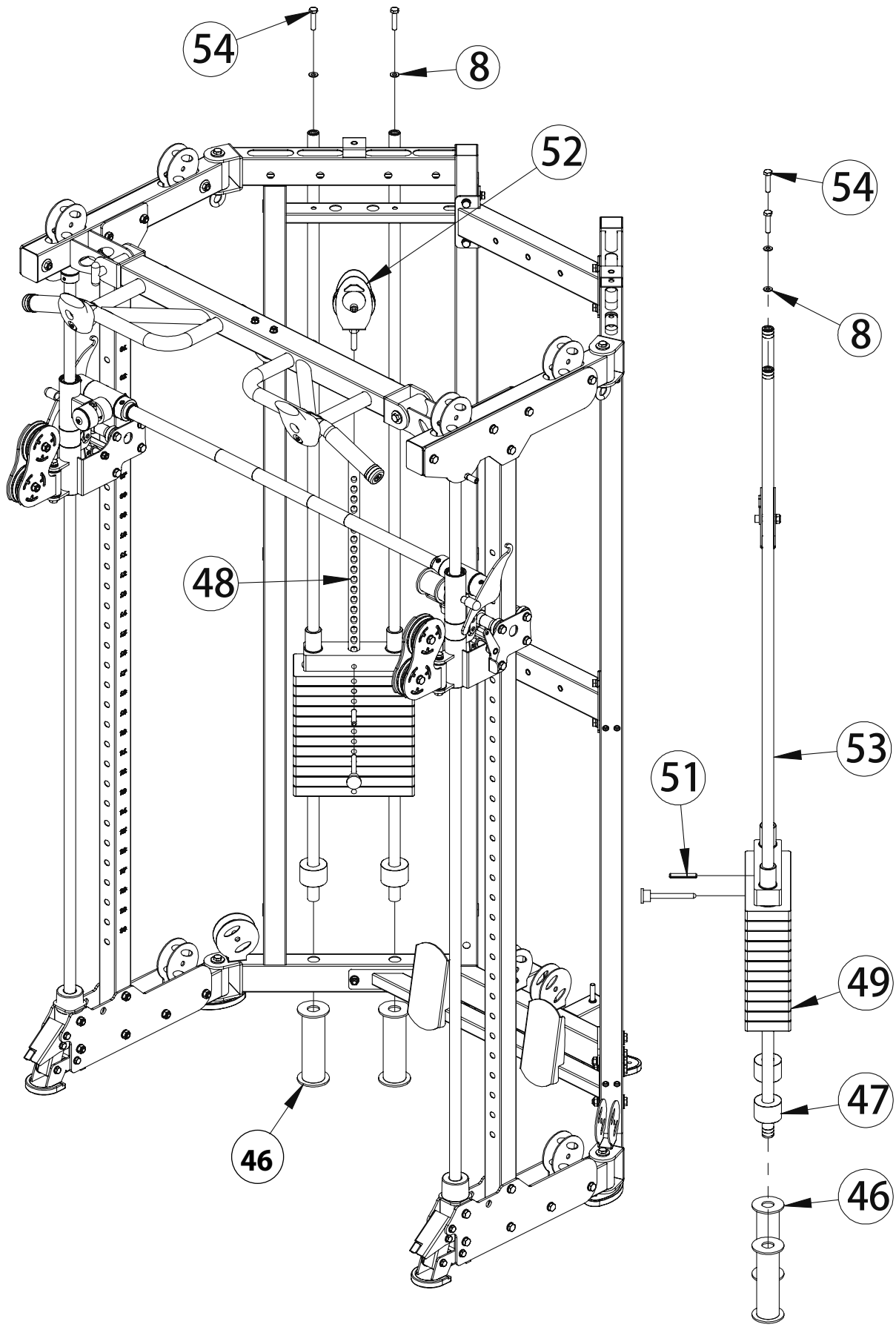

Step 7: Assembly of the Cables

① NOTICE

The pulleys are attached at the same time as the cable.

1. Feed the cable (62) between the two pulleys on the control unit.
2. Attach two pulleys (55) to the pulley holders on the connecting piece with a total of two bolts (54), four washers (8) and two nuts (12) and guide the cable (62) over the pulleys (55).
3. Guide the cable (62) under the upper pulley of the double pulley holder (61) and attach the end of the cable to the connecting piece using a carabiner (63).
4. Attach a pulley (55) to the guide pulley holder on the lower connecting frame using a bolt (54), a lock nut (12) and a washer (8) and guide the cable (64) under the pulley.
5. Attach a pulley (55) with a pulley cover (56) to the lower connecting frame with a lock nut (12) and a washer (8) and feed the cable (64) through the pulley.
6. Attach a pulley (60) to the bottom of the side frame using a bolt (58), two sleeves (57) and a lock nut (12) and guide the cable (64) upwards under the pulley.
7. Attach two pulleys (60) to the top of the side frame with a total of two bolts (58), four sleeves (57) and two lock nuts (12) and guide the cable (64) down over the pulleys, through the pulley holder on the weight plate and upwards.
8. Attach two pulleys (60) to the top of the side frame with a total of two bolts (58), four sleeves (57) and two lock nuts (12) and guide the cable (64) downwards over the pulleys.
9. Attach a pulley (55) to the pulley holder on the side frame using a bolt (54), two washers (8) and a lock nut (12) and guide the cable (64) upwards under the pulley and downwards under the lower pulley of the double pulley holder (61)
10. Attach a pulley (55) to the pulley holder on the base frame using a bolt (54), two washers (8) and a lock nut (12) and feed the cable (64) under the pulley.
11. Attach a pulley (60) to the pulley holder on the base frame using a bolt (16), two sleeves (59) and a lock nut (12) and guide the cable (64) upwards and attach the end of the cable to the actuator unit using a pin (65).
12. Repeat the steps on the other side.

① NOTICE

The cable length can be adjusted by turning the locking nut.

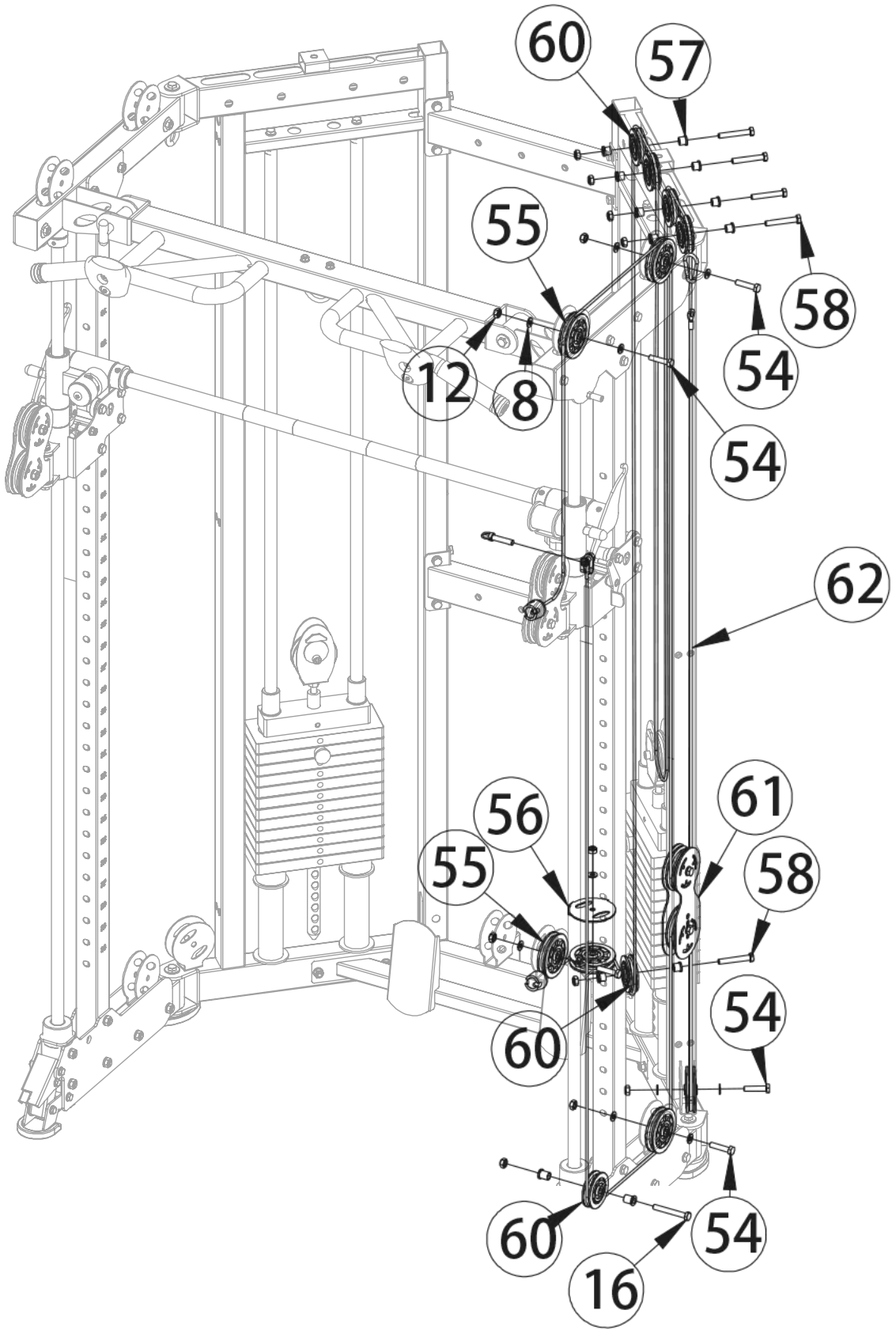

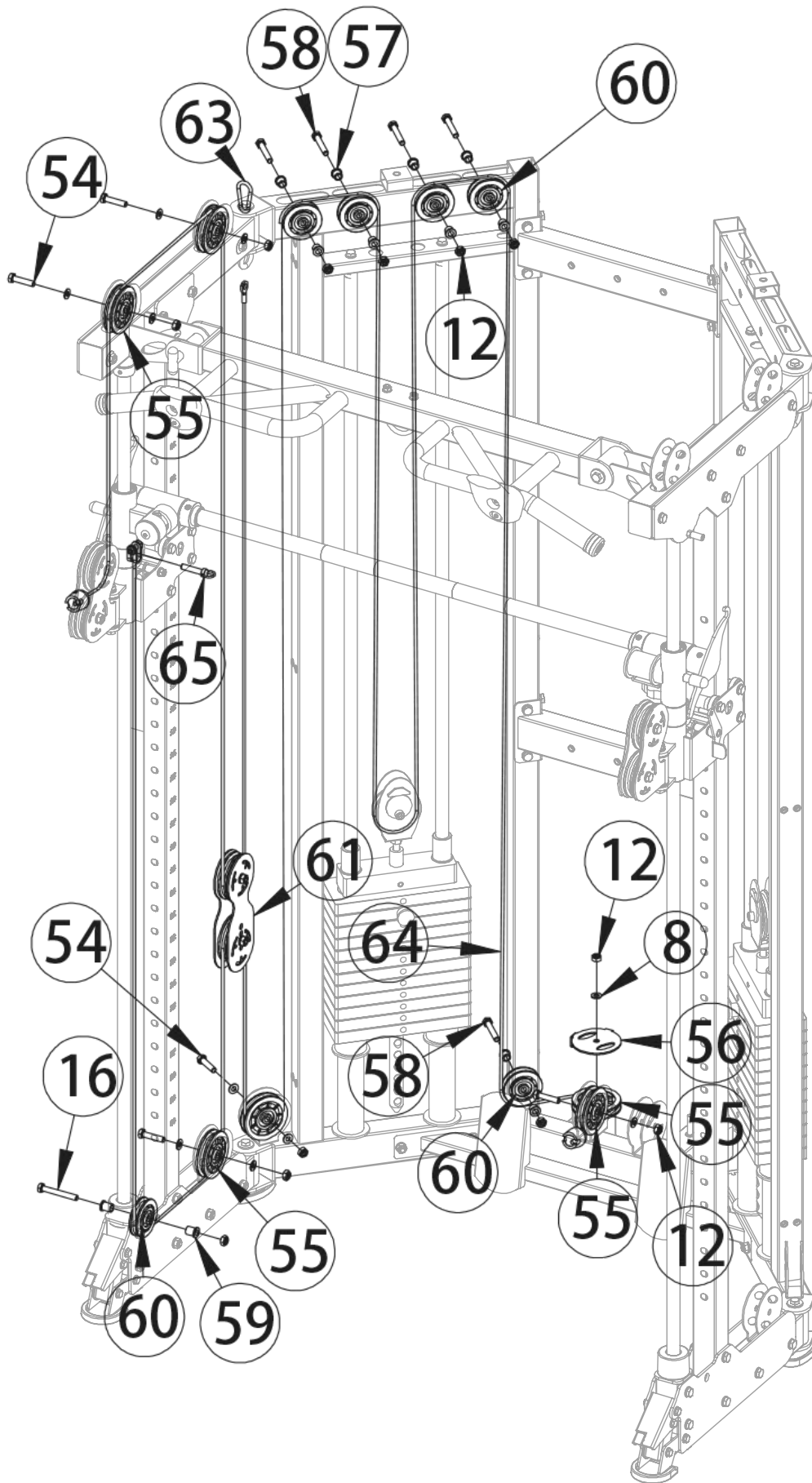

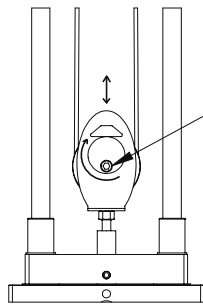

regulating screw

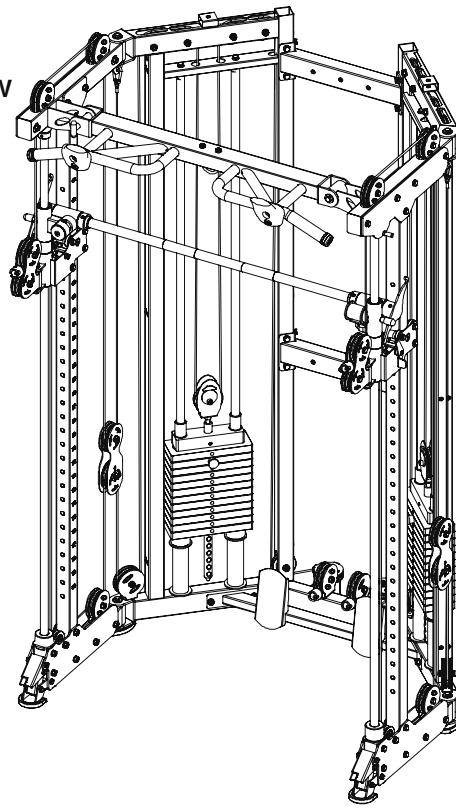

Step 8: Assembly of the Covers

1. Fit the right and left inner shields (67 & 69), the right and left outer shields (68 & 70) to the right and left upright frames (1 & 2) using a total of 24 bolts (24) and 24 washers (25).
2. Attach the top covers (66) to the right and left upright frames (1 & 2) with one bolt (24) and one washer (25) each.
3. Attach the hooks (71) to the middle link tube (10).

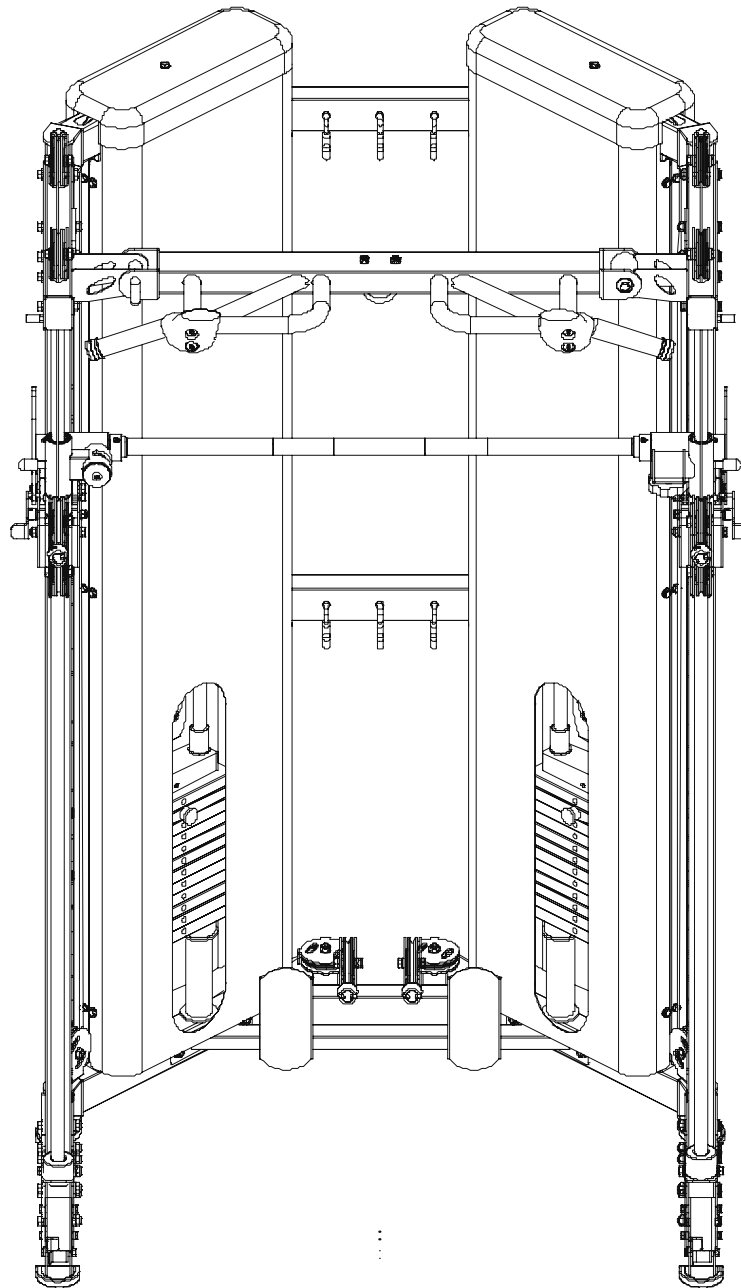

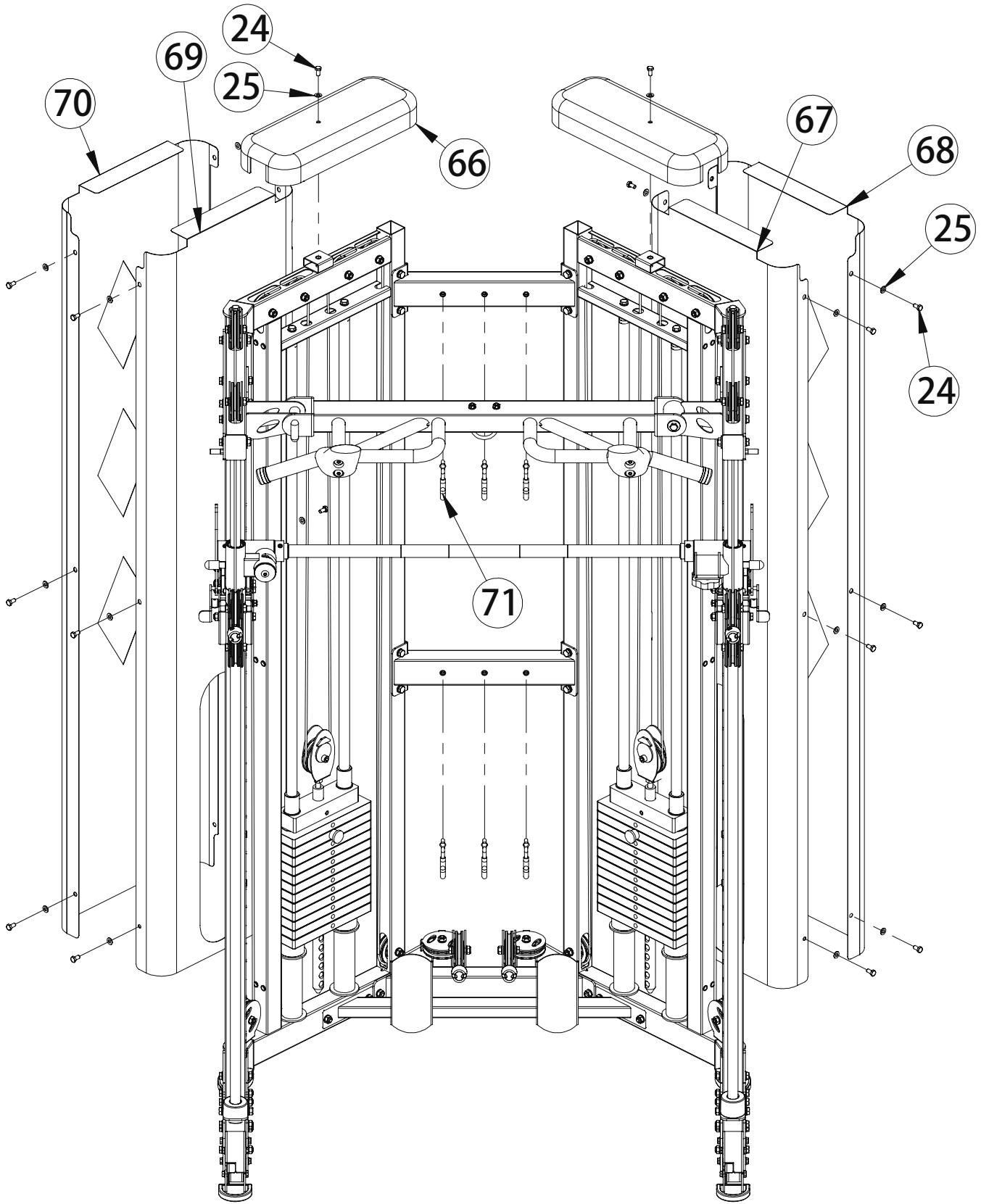

Using the folding mechanism

1. Remove the ring pull pins (65) from the sliding frames (22 & 23).
2. Loosen the adjusting locking spring knob (45).



CAUTION

Make sure that the Smith bar does not fall. Hold the Smith bar firmly while you loosen the adjusting knob.

3. Pull the sliding frame-left (23) upwards while folding the loose end of the Smith rod downwards.
4. Pull the ring pull pin (65) out of the pull-up bar (34).



CAUTION

Hold the barbell bar firmly so that it does not fold down unsecured.

5. Step onto one feet cover (19) at a time to operate the lever and release the stands.
6. Fold both sides together.

→ *The appliance is folded up.*

Accessories:

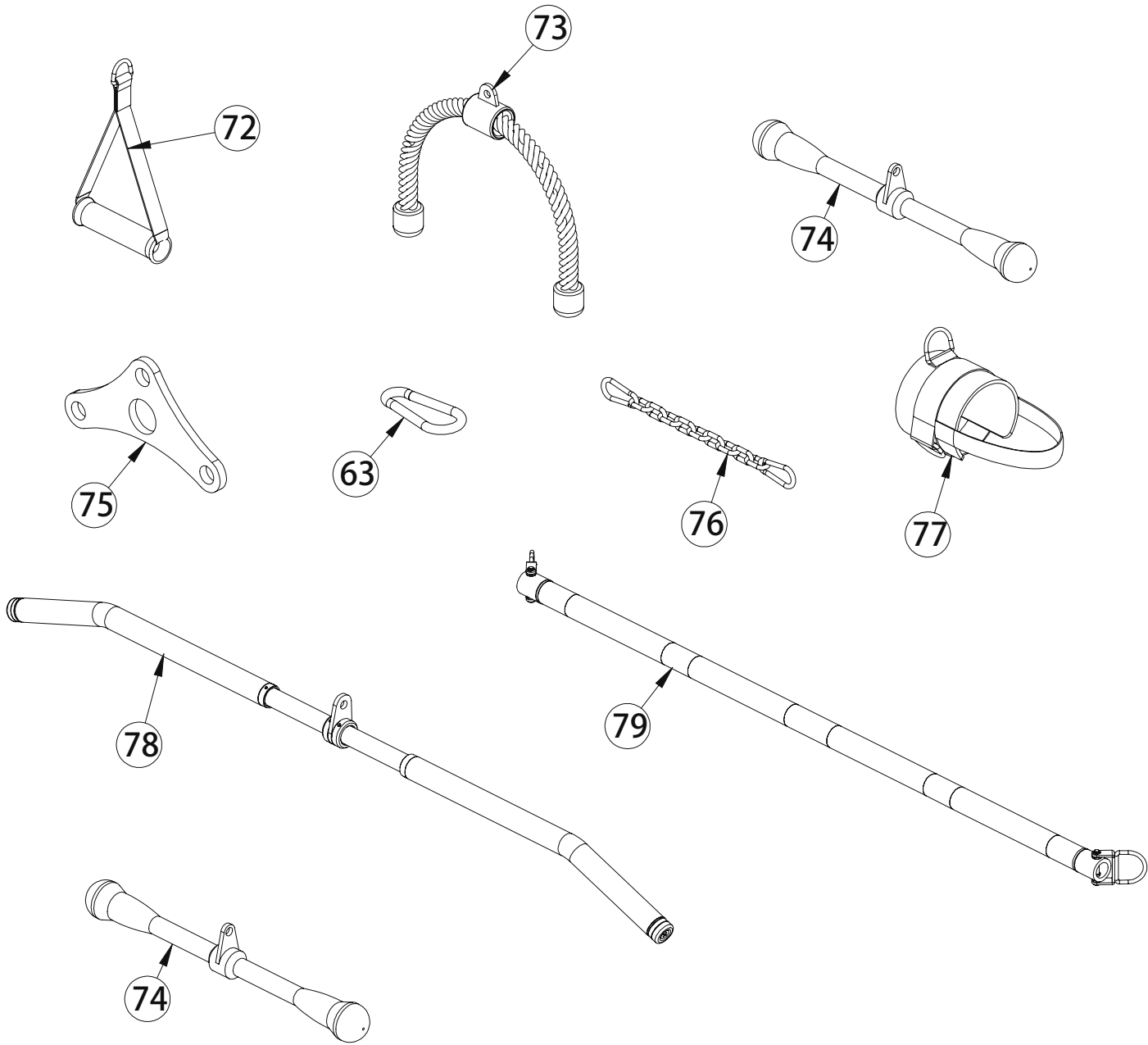

3.1 General Instructions

⚠ WARNING

- + The storage location should be chosen so that improper use by third parties or children can be prevented.
- + If your equipment does not have transportation wheels, the equipment must be disassembled before transportation.

▶ ATTENTION

- + Make sure that the equipment is protected from moisture, dust and dirt in the selected storage location. The storage location should be dry and well ventilated and have a constant ambient temperature between 10°C and 35°C.

4.1 General Instructions

WARNING

- + Do not make any improper changes to the equipment.

CAUTION

- + Damaged or worn components may affect your safety and the life of the equipment. Therefore, immediately replace damaged or worn components. In such a case, contact the contract partner. The equipment must not be used until it has been repaired. If necessary, use only original spare parts.

ATTENTION

- + In addition to the instructions and recommendations for maintenance and care given here, additional service and/or repair work may be necessary; this must only be carried out by authorised service technicians.

4.2 Faults and Fault Diagnosis

The equipment undergoes regular quality controls during production. Nevertheless, faults or malfunctions may occur. Frequently, individual parts are responsible for these disturbances, an exchange is usually sufficient. Please refer to the following overview for the most common errors and how to correct them. If the equipment still does not function properly, contact your contract partner.

Fault	Cause	Solution
Grinding noises	Cables or pulleys do not run smoothly or are damaged	+ Visual inspection of the cable routing or the pulley guide + If damaged, replace the defective part
Weight hanging in the air	Cable tensioned too tight	Readjust cable tension
Cable without tension	Cable too loose	+ Check cable routing + Readjust cable tension
Squeaking & cracking noises	Screw connections loosened or too tight	+ Check or lubricate screw connections* + Check cable routing
Unit wobbles	+ Uneven ground + Loose screw connections	+ Align unit + Tighten screw connections
Heavy draught	+ Weight holders/guide rods too dry + Faulty cable routing	+ Lubricate guide rods* + Check cable routing

* With a grease-free silicone oil or silicone spray.

4.3 Maintenance and Inspection Calendar

To avoid damage from body sweat, the equipment must be cleaned with a damp towel (no solvents!) after each training session.

The following routine tasks must be performed at the specified intervals:

Part	Weekly	Monthly	Quarterly
Cables	C	I	
Screw connections		I	
Pulleys and cable routing		I	
Slide rails/Guide rods		I	
Legend: C = clean; I = inspect			

5 DISPOSAL

At the end of its operational life, this equipment cannot be disposed of in normal household waste. Instead, it must be disposed of via a recycling centre. Further information can be obtained from your local authority's recycling service.

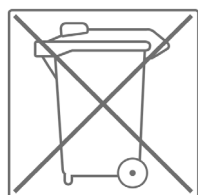

The materials can be recycled as per their symbols. Through the reuse, recycling of materials or other forms of recovery of old equipment, you make an important contribution to the protection of the environment.

6 RECOMMENDED ACCESSORIES

To make your training experience even more efficient and pleasant, we recommend that you add suiting accessories to your fitness equipment. For training equipment like smith machines, weight benches or racks this could for example be a **floor mat**, which makes your fitness equipment stand more securely and also protects the floor from sweat but it could be also **additional weights, handles, foot straps** for leg exercises or **triceps ropes**. For some smith machines, there are also optional add-ons such as **leg presses** that make your workout even more intense and comprehensive.

Our range of accessories offers the highest quality and makes training even better. If you would like to find out more about compatible accessories, please go to the detail page of the product in our webshop (the easiest way is to enter the article number in the search field above) and go to the recommended accessories on this page. Of course, you can also contact our customer service: by telephone, e-mail, in one of our branches or via our social media channels. We will be happy to advise you!



floor mat



chest strap



tricep and curl bar



triceps rope

7.1 Serial Number and Model Name

In order to provide you with the best possible service, please have the model name, article number, serial number, exploded drawing and parts list ready. The corresponding contact options can be found in chapter of this operating manual.

ⓘ NOTICE

The serial number of your equipment is unique. It's located on a white sticker.

Enter the serial number in the appropriate field.

Serial number:

Brand / Category:

Model Name:

SKU:

7.2 Parts List

No.	Name	Specification	Qty.
1	Upright Frame-Right		1
2	Upright Frame-Left		1
3	Down Side Link Tube		2
4	Hexagon Bolt(Black)	M10*20	6
5	Big Flat Washer	φ30*φ10*3	22
6	Internal Thread Axle	Φ20*85	5
7	Hexagon Socket Button Head Screws	M10*25	3
8	Flat Washer(Black)	φ10	90
9	Down Back Link Tube		1
10	Middle Link Tube		2
11	Hexagon Bolt	M10*70	14
12	Lock Nut	M10	52
13	Spring Washer	φ10	17
14	Hexagon Bolt	M10*25	16
15	Leg Press		1
16	Hexagon Bolt	M10*75	20
17	Down Fixing Plate		4
18	Front Standing Tube-Right		1
19	Feet Cover		2
20	Internal Thread Axle	φ12*59.5	4
21	Front Standing Tube-Left		1
22	Sliding Frame-Right		1
23	Sliding Frame-Left		1
24	Hexagon Bolt	M8*16	34
25	Flat Washer	φ8	34
26	Rubber Block	φ60*φ26*45	2
27	Sliding Sleeve-Right		1
28	Guide Rod	φ25*1850	2
29	Rubber Block	φ48*φ25.5*42	2
30	Lock Sleeve	φ40*φ25.5*35	2
31	Headless Hexagon Socket Bolt	M8*10	2

32	Sliding Sleeve-Left		1
33	Thread Pin		2
34	Chin Up Frame		1
35	Up Fixing Plate		2
36	Up Side Link Tube		1
37	Up Side Link Tube-Left		1
38	Back Fixing Plate		2
39	Ring	M10	2
40	T Shape Pin	φ12*110	1
41	Barbell Bar		1
43	Aluminum Cap		1
44	Hexagon Socket Button Head Screws	M10*20	1
45	Locking Spring Knob	M16	1
46	Weight Support Tube		4
47	Rubber Block	φ60*φ27*42	4
48	Selector Rod		2
49	Weight Plate		2
50	Magnetic Pin	φ60*100	2
51	Open Hollow Pin	10*60	2
52	Pulley Holder		2
53	Stainless Steel Rod		4
54	Hexagon Bolt	M10*45	14
55	Pulley	φ92	12
56	Pulley Cover		2
57	Powder Metallurgy	20*φ16*φ10.5*15	20
58	Hexagon Bolt	M10*65	10
59	Powder Metallurgy	20*φ16*φ10.5*20.5	4
60	Pulley	φ75	12
61	Rotating Pulley Holder		2
62	Fly-Bird Cable		2
63	Carabiner		6
64	Weight Cable		2
65	Ring Pull Pin	φ10*45	2
66	Top Cover		2

67	Inner Shield-Right		1
68	Outer Shield-Right		1
69	Inner Shield-Left		1
70	Outer Shield-Left		1
71	Hook		6
72	Plastic Handle		2
73	Triceps Rope		1
74	Short Straight Bar		1
75	Triangle Plate		1
76	Carabiner And Chain		3
77	Ankle Cuff		1
78	Lat Pull-Down Bar		1
79	Long Straight Bar		1
80	SPring		2

7.3 Exploded Drawing

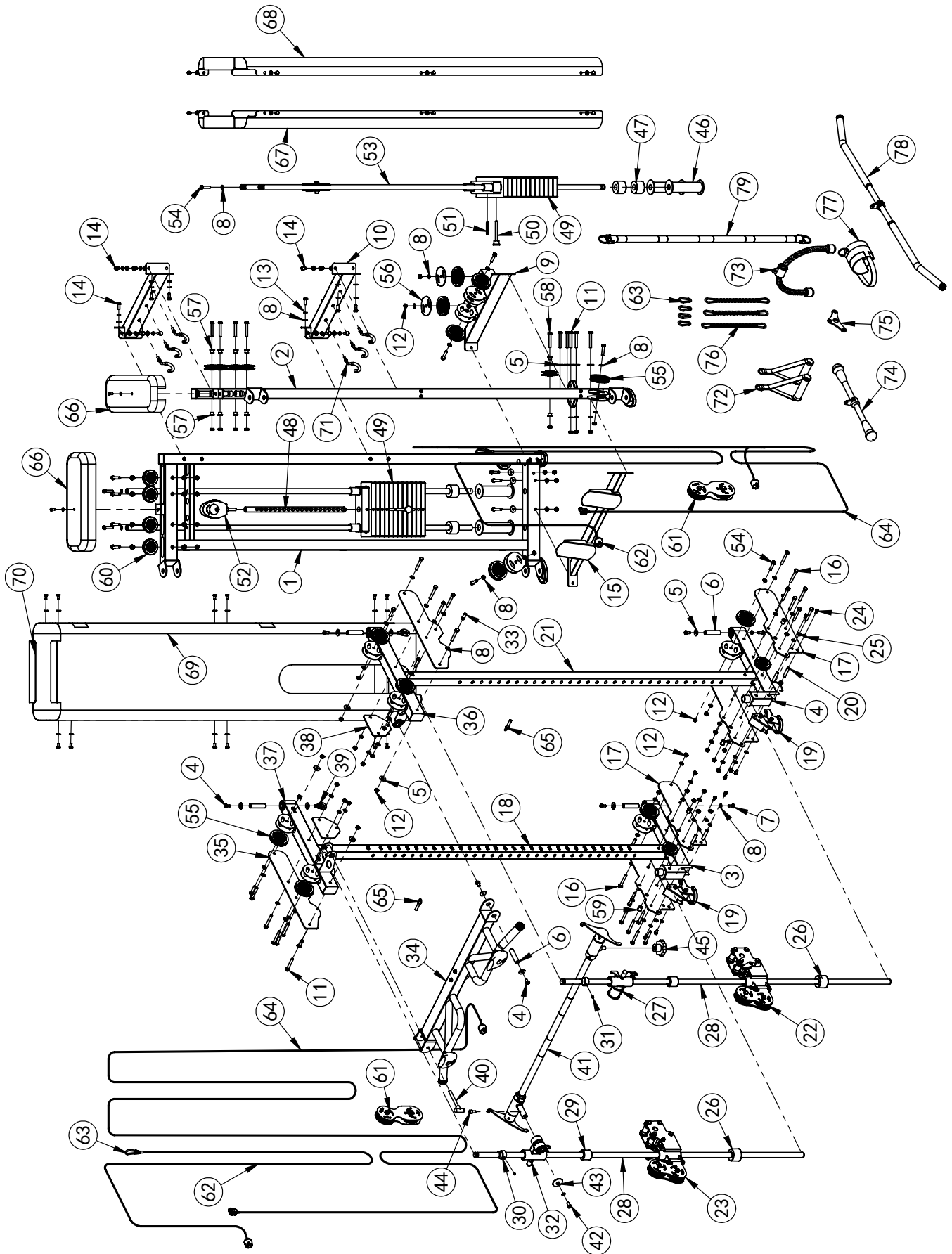

Products from Taurus® are subject to strict quality control. However, if a fitness equipment purchased from us does not work perfectly, we take it very seriously and ask you to contact our customer service as indicated. We are happy to help you by phone via our service hotline.

Error Descriptions

Your fitness equipment is developed for long-term, high-quality training. However, should a problem arise, please first read the operating instructions. For further assistance, please contact your contract partner or call our service hotline. To ensure your problem is solved as quickly as possible, please describe the defect as exactly as possible.

In addition to the statutory warranty, we provide a warranty for every fitness equipment purchased from us according to the following provisions.

Your statutory rights are not affected.

Warrantee

The warrantee is the first/original buyer.

Warranty periods

The following warranty periods begin on delivery of the fitness equipment.

Warranty period

The warranty periods, shown on our web shop, begin on delivery of the fitness equipment. The respective warranty periods for your equipment can be found on its product website.

Repair Costs

According to our choice, there will either be a repair, a replacement of individual damaged parts or a complete replacement. Spare parts, that have to be mounted while assembling the equipment, have to be replaced by the warrantee personally and are not a part of repair. After the expiration of the warranty period, the responsibility for parts costs, repair costs, installation costs and delivery costs lies with the warranty holder.

The terms of use are defined as follows:

- + Home use: solely for private use in private households up to 3 hours per day
- + Semi-professional use: up to 6 hours per day (e. g. rehabilitation centres, hotels, clubs, company gyms)
- + Professional use: more than 6 hours per day (e. g. commercial gyms)

Warranty Service

Within the warranty period, equipment which develops faults as a result of material or manufacturing defects, will be repaired or replaced at our discretion. Ownership of equipment or parts of equipment which have been replaced is transferred to us. The warranty period is not extended nor does a new warranty period begin following repair or replacement under the warranty.

Warranty Conditions

For the warranty to be valid, the following steps must be taken:

Please contact our customer service by email or phone. If the product under warranty has to be sent in for repair, the seller bears costs. After expiry of the warranty, the buyer bears the costs of transport and insurance. If the fault is covered by our warranty, you will receive a new or repaired equipment in return.

Warranty claims are invalid in case of damage resulting from:

- + misuse or improper handling
- + environmental influences (moisture, heat, electrical surge, dust, etc.)
- + failure to follow the current safety measures for the equipment
- + failure to follow the operating instructions
- + use of force (e. g. hitting, kicking, falling)
- + interventions which were not carried out by one of our authorized service centres
- + unauthorised repair attempts

Proof of Purchase and Serial Number

Please make sure that you are able to provide the appropriate receipt when claiming on your warranty. So that we can clearly identify the model of your equipment, and for the purposes of our quality control, you will need to give the serial number of your equipment, when contacting the service team. Where possible please have your serial number and your customer number ready when you call our service hotline. It will help us to deal with your request swiftly.







































If you cannot find the serial number on your fitness equipment, our service team is at your disposal to offer further information.

Service outside of the Warranty Period

We are also happy to issue an individual cost estimate if there is a problem with your fitness equipment after the warranty has expired, or in cases which do not fall under the terms of the warranty, e. g. normal wear and tear. Please contact our customer service team to find a quick and cost-effective solution to your problem. In such a case you will be responsible for the delivery costs.

Communication

Many problems can be solved just by speaking to us as your specialist supplier. We know how important it is to you as a user of the fitness equipment to have problems solved quickly and simply, so you can enjoy working out with minimal interruption. For that reason, we also want to resolve your queries quickly and in a straightforward manner. Thus, please always keep your customer number and the serial number of the faulty equipment handy.

DE	DK	UK
<p>TECHNIK</p> <p> +49 4621 4210-900</p> <p> +49 4621 4210-698</p> <p> technik@fitshop.de</p> <p> Öffnungszeiten entnehmen Sie unserer Homepage.</p> <p>SERVICE</p> <p> 0800 20 20277 (kostenlos)</p> <p> 04621 4210 - 0</p> <p> info@fitshop.de</p> <p> Öffnungszeiten entnehmen Sie unserer Homepage: https://stg.fit/statita</p>	<p>TEKNIK OG SERVICE</p> <p> 80 90 16 50</p> <p>+49 4621 4210-945</p> <p> info@fitshop.dk</p> <p> Åbningstider kan findes på hjemmesiden: https://stg.fit/statit7</p>	<p>CUSTOMER CARE POWERHOUSE</p> <p> +44 141 737 2249 or +44 141 876 3972</p> <p> customercare@fitshop.co.uk</p> <p> You can find the opening hours on our homepage: https://stg.fit/statitd</p>
	FR	BE
	<p>TECHNIQUE & SERVICE</p> <p> +33 (0) 189 530984</p> <p>+49 4621 42 10 933</p> <p> info@fitshop.fr</p> <p> Vous trouverez les heures d'ouverture sur notre site Internet: https://stg.fit/statit4</p>	<p>TECHNIQUE & SERVICE</p> <p> 02 732 46 77</p> <p>+49 4621 4210 933</p> <p> info@fitshop.be</p> <p> Vous trouverez les heures d'ouverture sur notre site Internet: https://stg.fit/statit8</p>
ES	NL	INT
<p>TECNOLOGÍA Y SERVICIOS</p> <p> 911 238 029</p> <p> info@fitshop.es</p> <p> Consulta nuestro horario de apertura en la página web: https://stg.fit/statit5</p>	<p>TECHNISCHE DIENST & SERVICE</p> <p> +31 172 619961</p> <p> service@fitshop.nl</p> <p> De openingstijden vindt u op onze homepage: https://stg.fit/statit3</p>	<p>TECHNICAL SUPPORT & SERVICE</p> <p> +49 4621 4210-944</p> <p> service-int@fitshop.de</p> <p> You can find the opening hours on our homepage: https://stg.fit/statita</p>
PL	AT	CH
<p>DZIAŁ TECHNICZNY I SERWIS</p> <p> 22 307 43 21</p> <p>+49 4621 42 10-948</p> <p> info@fitshop.pl</p> <p> Godziny otwarcia można znaleźć na stronie głównej: https://stg.fit/statit6</p>	<p>TECHNIK & SERVICE</p> <p> 0800 20 20277 (Freecall)</p> <p>+49 4621 42 10-0</p> <p> info@fitshop.at</p> <p> Öffnungszeiten entnehmen Sie unserer Homepage: https://stg.fit/statitb</p>	<p>TECHNIK & SERVICE</p> <p> 0800 202 027</p> <p>+49 4621 42 10-0</p> <p> info@fitshop.ch</p> <p> Öffnungszeiten entnehmen Sie unserer Homepage: https://stg.fit/statit9</p>

Please find a detailed overview including address and opening hours for all stores of Powerhouse Fitness in the UK on the following website:

www.fitshop.co.uk/storelocator

WE LIVE FITNESS

WEBSHOP AND SOCIAL MEDIA

The Fitshop Group is Europe's largest specialist for home fitness equipment with currently 70 stores and one of the world's most renowned online mail order companies for fitness equipment.

Fitshop UK is part of the Fitshop Group. Private customers order via the 25 web shops in the respective national language or have their desired equipment assembled on site. In addition, the company supplies fitness studios, hotels, sports clubs, companies and physio practices with professional equipment for endurance and strength training.

The Fitshop group offers a wide range of fitness equipment from renowned manufacturers, high-quality in-house developments and comprehensive services, such as a build-up service and sports scientific advice before and after the purchase. The company employs numerous sports scientists, fitness trainers and competitive athletes.

Visit us also on our social media platforms or our blog!

**FIT
SHOP**

<https://www.fitshop.co.uk/>
www.fitshop.co.uk/blog/



www.facebook.com/fitshop.co.uk



www.instagram.com/fitshop_uk



www.youtube.com/@fitshop_uk

TAURUS

 cardiostrong

BODYCRAFT

BodyMax

TAURUS®

Taurus MS40 Pro