

TAURUS®

Assembly and Operating Instructions

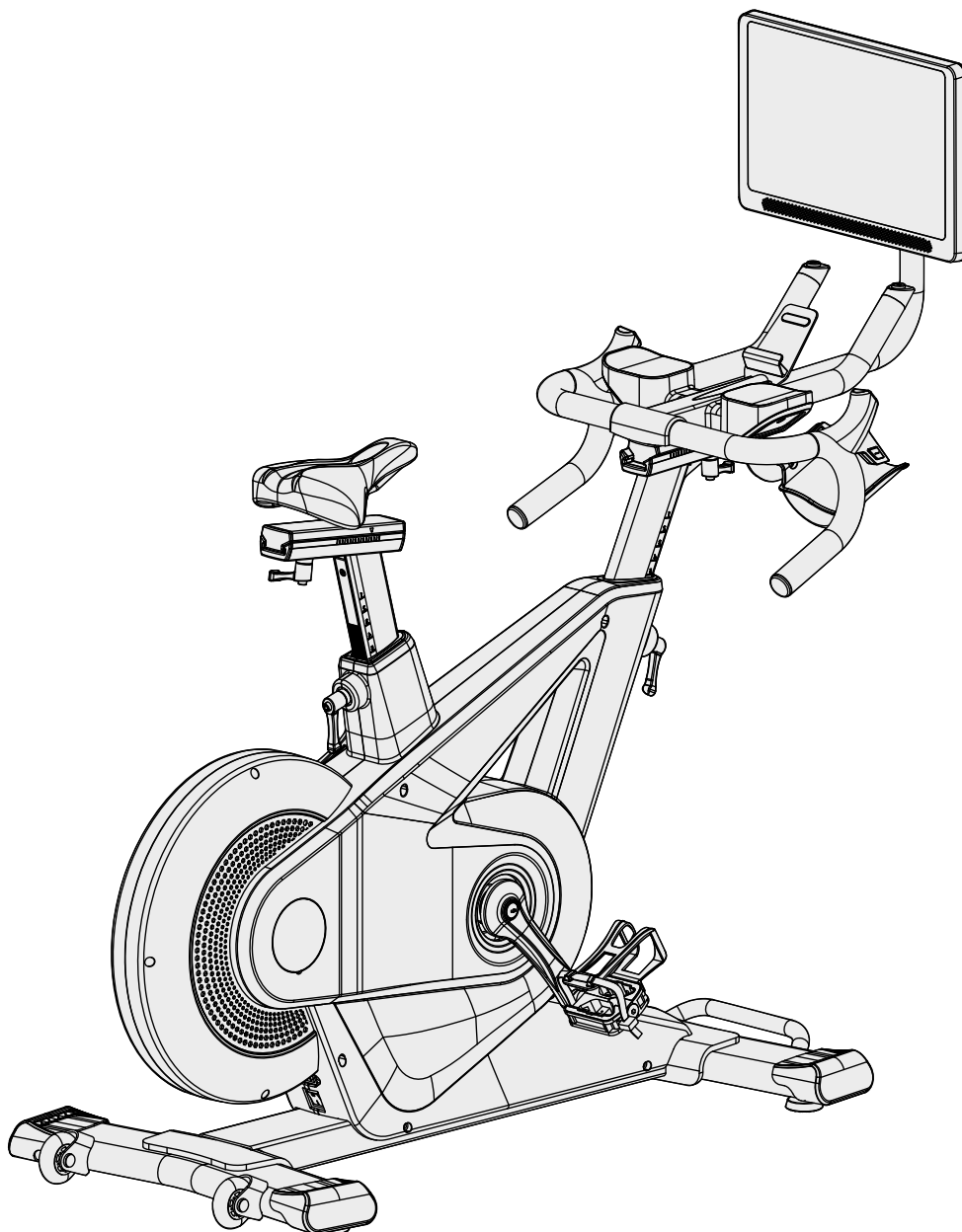

max. 180 kg



~ 60 Min



60 kg

L 169 | B 60 | H 162

FSUKTFRACERT.01.01

SKU: TF-RACER-T

Taurus Racer Pro Touch

Content

1	GENERAL INFORMATION	8
1.1	Technical Data	8
1.2	Personal Safety	9
1.3	Electrical Safety	10
1.4	Set-Up Place	11
2	ASSEMBLY	12
2.1	General Instructions	12
2.2	Scope of Delivery	13
2.3	Assembly	15
3	OPERATING INSTRUCTIONS	24
3.1	Console Display	24
3.2	Button Functions	25
3.3	Further Functions	26
3.4	Programmes	27
3.4.1	Quick-Start Programme/Target Programme	28
3.4.2	Pre-set Programmes	29
3.4.3	Interval Programme	30
3.4.4	Heart Rate Controlled Programmes	31
3.4.5	Watt Programme	33
3.4.6	Virtual Training Routes	34
3.5	Multimedia and Software Updates	37
3.6	Compatibility Training Apps	39
3.6.1	Connection with Kinomap	40
4	STORAGE AND TRANSPORT	41
4.1	General Instructions	41
4.2	Transportation Wheels	41
5	TROUBLESHOOTING, CARE AND MAINTENANCE	42
5.1	General Instructions	42
5.2	Faults and Fault Diagnosis	42
5.3	Error Codes and Troubleshooting	43
5.4	Maintenance and Inspection Calendar	44
6	DISPOSAL	44
7	RECOMMENDED ACCESSORIES	45

8	ORDERING SPARE PARTS	46
8.1	Serial Number and Model Name	46
8.2	Parts List	47
8.3	Exploded Drawing	52
9	WARRANTY	53
10	CONTACT	55

Dear customer,

Thank you for choosing quality training equipment from the TAURUS® brand. Taurus offers sports and fitness equipment for home users with high demands on quality, functionality and longevity. Also, Taurus is a well-known and experienced brand for equipping professional rooms for fitness studios and business customers. The focus of Taurus fitness equipment is on what matters most in sports: maximum performance! Therefore, the devices are developed in close consultation with athletes and sports scientists. Because athletes know best what makes perfect fitness equipment.

Further information can be found at www.fitshop.co.uk

Intended Use

The equipment may only be used for its intended purpose.

This fitness equipment is suitable for home use, semi-professional use and commercial or professional use. The semi-professional sector includes, for example, institutional facilities such as hospitals, schools, hotels and associations. Professional use refers to commercial use, e.g. in a fitness studio.

Legal Notice

Fitshop GmbH
Europe's No. 1 for home fitness

International Headquarters
Flensburger Straße 55
24837 Schleswig
Germany

Management:
Christian Grau
Sebastian Campmann
Dr. Bernhard Schenkel
No. HRB 1000 SL
Local Court Flensburg
European VAT Number: DE813211547

Disclaimer

© TAURUS is a registered brand of the company Fitshop GmbH. All rights reserved. Any use of this trademark without the explicit written permission of Fitshop is prohibited.

Product and manual are subject to change. Technical data can be changed without advance notice.

FITSHOP

Europe's No.1 for Home Fitness

ABOUT THIS MANUAL

Please carefully read the entire manual before installation and first use. The manual will help you to quickly set up the system and explains how to safely use it. Make sure that all persons exercising with the equipment (especially children and persons with physical, sensory, mental or motor disabilities) are informed about this manual and its contents in advance. In case of doubt, responsible persons must supervise the use of the equipment.

Due to ongoing changes and software optimisations, the manual may have to be updated. If you notice any discrepancies during assembly or use, please refer to the manual uploaded to the webshop. The latest manual is always available there.



This equipment has been manufactured according to the latest safety knowledge. As far as possible, potential safety hazards which could cause injury have been eliminated. Make sure to carefully follow the instructions and that all parts are securely in place. If required, read through the instructions again to correct any mistakes.

Training devices must be classified according to accuracy and use. Accuracy classes are only applicable to devices that display training data.

Accuracy classes

Class A: high accuracy.

Class B: medium accuracy.

Class C: low accuracy.

The use classes explain the intended use of the training device.

Use classes

Class S (studio): professional and/or commercial use.

These training devices are intended for the use in training rooms of facilities such as sports clubs, school facilities, hotels, clubs and studios whose access and supervision is specifically regulated by the owner (person with legal responsibility).

Class H (home use): use at home.

These stationary training devices are intended for the use in private homes where access to the training device is regulated by the owner (person with legal responsibility).

Please pay close attention to the safety and maintenance instructions given here. The contract partner cannot be held liable for damage to health, accidents or damage to the equipment when it is not used in accordance with these instructions.

The following safety instructions may appear in this manual:

► **ATTENTION**

This notice indicates potentially hazardous situations which, if not avoided, may result in property damage.

⚠ **CAUTION**

This notice indicates potentially hazardous situations which, if not avoided, may result in slight or minor injuries!

⚠ **WARNING**

This notice indicates potentially hazardous situations which, if not avoided, may result in death or serious injuries!

⚠ **DANGER**

This notice indicates potentially hazardous situations which, if not avoided, will result in death or serious injuries!

ⓘ **NOTICE**

This notice indicates further useful information.

Retain these instructions in a safe place for future reference, maintenance or when ordering replacement parts.

1.1 Technical Data

TFT Display of

- + Speed in km/h
- + Rotations per minute
- + Training time in min
- + Training distance
- + Calorie consumption in kcal
- + Heart rate (when using the chest strap)
- + Watt

Resistance system:	induction brake system
Resistance levels:	80
Flywheel mass:	12 kg

Wattage	
Min. and max. watt at 60 RPM:	30 - 650 W
Min. and max. watt at 100 RPM:	58 - 1094 W

Weight and Dimensions

Packaging dimensions (L x W x H) approx.:	125.5 cm x 27.5 cm x 94 cm
Set-up dimensions (L x W x H) approx.:	168.5 cm x 60 cm x 162 cm

Article weight (gross, incl. packaging) approx.:	66.5 kg
Article weight (net, excl. packaging) approx.:	60 kg

Maximum user weight:	180 kg
----------------------	--------

Q-factor:	16.5 cm
-----------	---------

Use class:	S
------------	---

1.2 Personal Safety

DANGER

- + Before you start using the equipment, you should consult your physician that this type of exercise is suitable for you from a health perspective. Particularly affected are persons who: have a hereditary disposition to high blood pressure or heart disease, are over the age of 45, smoke, have high cholesterol values, are overweight and/or have not exercised regularly in the past year. If you are under medical treatment that affects your heart rate, medical advice is absolutely essential.
- + Note that excessive training can seriously endanger your health. Please also note that heart rate monitoring systems can be inaccurate. If you notice any signs of weakness, nausea, dizziness, pain, shortness of breath, or other abnormal symptoms, stop exercising immediately and seek advice from your doctor if necessary.
- + The owner must communicate all warnings and instructions to the user.

WARNING

- + This equipment may not be used by children under the age of 14.
- + Children should not be allowed unsupervised access to the equipment.
- + Persons with disabilities must have a medical license and must be under strict observation when using the equipment.
- + The equipment is strictly for use by one person at a time.
- + If your equipment provides a safety key, the clip of the safety key must be attached to your clothing before starting your training. In the event of a fall, the EMERGENCY STOP of the equipment can be initiated.
- + There is a risk of injury from spinning pedals and/or an exposed flywheel in the absence of a freewheel. Never get on or off the equipment when the pedals or the flywheel are still moving. Always make sure that the pedals and the flywheel have come to a complete stop.
- + Support yourself with at least one hand on the handlebar when getting on and off the equipment. Only dismount from the equipment when the pedals have come to a complete stop.
- + Keep your hands, feet and other body parts, hair, clothing, jewellery and other objects well clear of moving parts.
- + During use, wear suitable sports clothing rather than loose or baggy clothing. When wearing sports shoes, make sure they have suitable soles, preferably made of rubber or other non-slip materials. Shoes with heels, leather soles, studs or spikes are unsuitable. Never exercise barefoot.

CAUTION

- + If your equipment needs to be connected to the power supply with a mains cable, make sure that the cable is not a potential tripping hazard.
- + Make sure that nobody is within the range of motion of the equipment during training so as not to endanger you or other persons.
- + Always tighten the pedal strap before you start training to prevent your feet from slipping.

⚠ CAUTION

- + Be aware that if adjustment devices are left protruding, they may impede the user's movement.

▶ ATTENTION

- + Do not insert any objects of any kind into the openings of the device.
- + To protect the equipment from use by unauthorised third parties, always remove the power cable when not in use and store it in a safe place that is inaccessible to unauthorised persons (e.g. children).
- + Class B and C crank training equipment is not suitable for high accuracy purposes.

1.3 Electrical Safety

⚠ DANGER

- + In order to reduce the risk of an electric shock, always unplug the equipment from the mains socket immediately after your workout, before assembly or dismantling, and before maintenance or cleaning. Do not pull on the cable.

⚠ WARNING

- + Do not leave the equipment unattended while the mains cable is plugged into the mains socket. During your absence, the mains cable must be removed from the mains socket to prevent improper use by third parties or children.
- + If the mains cable or plug is damaged or defective, contact your contract partner. Until repair, the equipment must not be used.

▶ ATTENTION

- + The equipment requires a mains connection of 220-230 V with 50 Hz mains voltage.
- + The equipment may only be connected directly to an earthed socket using the supplied mains cable. Extension cables must conform to VDE guidelines. Always completely unwind the mains cable.
- + The socket must be protected by a fuse with a minimum fuse rating of "16 A, slow blow".
- + Do not make any changes to the mains cable or the mains plug.
- + Keep the mains cable away from water, heat, oil and sharp edges. Do not route the mains cable underneath the equipment or under a carpet or rug, and do not place any objects on top of it.
- + If your purchased item is equipped with a TFT console, software updates must be carried out regularly. Follow the instructions on the console to perform the update(s).
- + The software systems on gym equipment with TFT consoles are set up only for the pre-installed apps. Do not install any additional apps.

ⓘ NOTICE

- + The pre-installed apps on TFT consoles are produced and provided by external manufacturers. Fitshop does not take any responsibility for the availability, functionality or contents of these apps.

1.4 Set-Up Place

⚠ WARNING

- + Do not place the equipment in main corridors or escape routes.

⚠ CAUTION

- + Choose a location in which to place the equipment such that there is enough free space/clearance to the front, the rear and to the sides of the equipment.
- + The training room should be well ventilated during training and not be exposed to any draughts.
- + Choose the place in which to set up the equipment such that there is enough free space/clearance to the front, the rear and to the sides of the equipment.
- + The free area in the direction from which the exercise equipment is accessed must be at least 0.6 m larger than the exercise area.
- + The set-up and mounting surface of the equipment should be flat, loadable and solid.

▶ ATTENTION

- + The device may only be used in one building, in sufficiently tempered and dry rooms (ambient temperatures between 10°C and 35°C). The equipment should not be used outdoors or in rooms with high humidity (over 70%) like swimming pools.
- + A floor protective mat/equipment underlay can help to protect high-quality floor coverings (parquet, laminate, cork, carpets) from dents and sweat and can help to level out slight unevenness.
- + For Class S equipment, the exercise equipment may only be used in areas where access, supervision and control are specifically regulated by the owner.

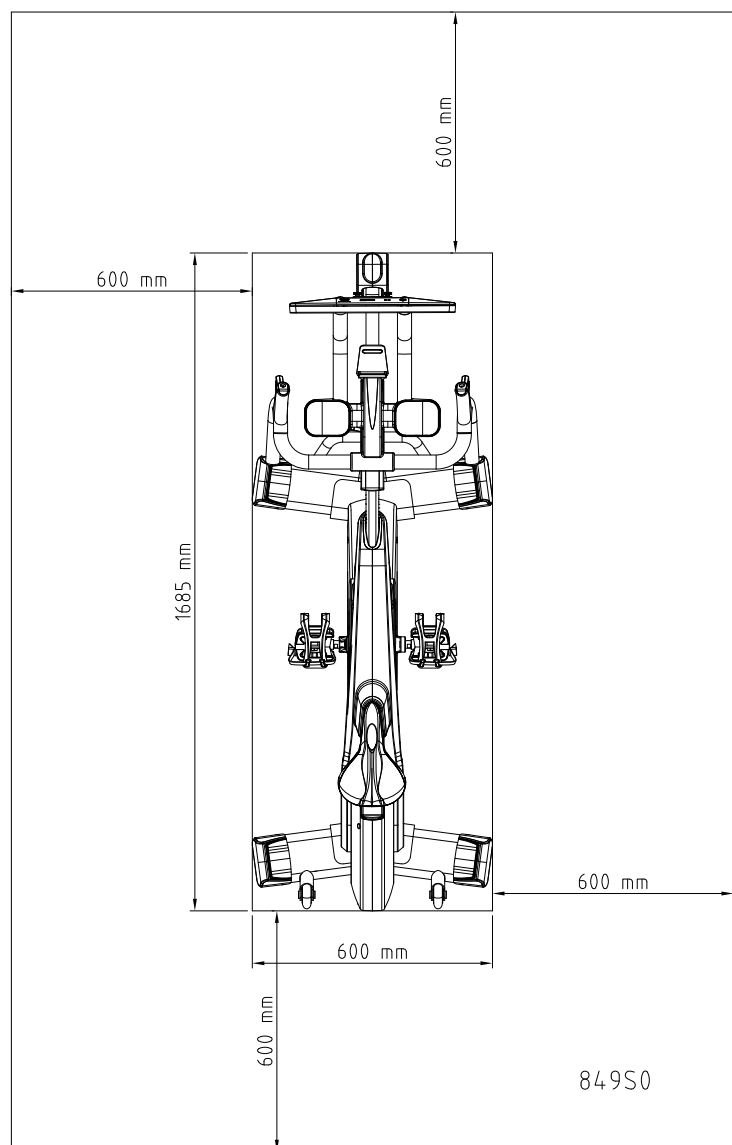

2.1 General Instructions

DANGER

- + Do not leave any tools, packaging materials such as foils or small parts lying around, as otherwise there is a danger of suffocation for children. Keep children away from the equipment during assembly.

WARNING

- + Pay attention to the instructions attached to the equipment in order to reduce the risk of injuries.

CAUTION

- + Ensure to have sufficient room for movement in each direction during assembly.
- + The assembly of the equipment must be carried out by at least two adults. If in doubt, seek the help of a third technically skilled person.

ATTENTION

- + To prevent damage to the equipment and the floor, assemble the equipment on a mat or packaging board.

NOTICE

- + In order to make the assembly as simple as possible, some screws and nuts to be used can already be pre-assembled.
- + Ideally, assemble the equipment at its later set-up place.

2.2 Scope of Delivery

The scope of delivery consist of the following parts. At the beginning, check whether all parts and tools belonging to the device are included in the scope of delivery and whether damage has occurred. In the event of complaints, the contractual partner must be contacted directly.

 **CAUTION**

If parts of the scope of delivery are missing or damaged, the assembly must not be carried out.

Part No.	Description	Qty.
1	Main frame	1
2	Rear stabilizer	1
4	Front stabilizer	1
8	Computer supporting tube	1
36	Handlebar	1
42L & 42R	Left and right handbar protective cover	1
43	Handbar protective cover	1
51L & 51R	Pedal set	1
54L & 54R	Left and right bottle holder	1
66	Power cord	1
76	Computer	1
	Screw kit	1

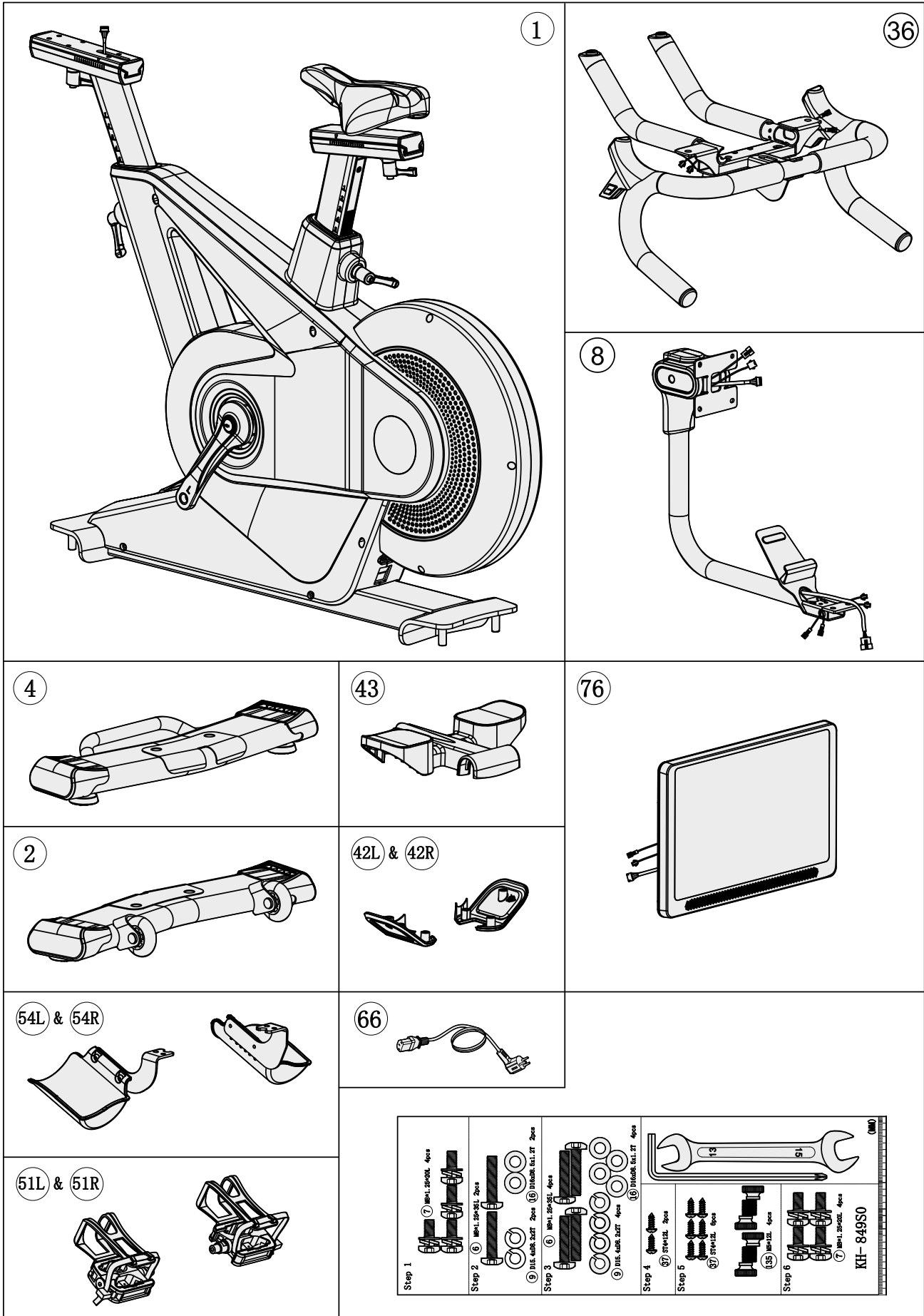

2.3 Assembly

Before assembly, take a close look at the individual assembly steps shown and carry out the assembly in the order given.

① NOTICE

- + First loosely screw all parts together and check that they fit properly. Tighten the screws using the tool only when you are instructed to do so.
- + If you have difficulty recognising the graphics, we recommend that you open and/or download the PDF instructions stored in the webshop on your end device (e.g. smartphone, tablet or PC). There you have the option of zooming in closer. Please note that the Adobe Acrobat Reader programme must be installed on your end device in order to open the file.

Step 1: Assembly of the Stabilizers

Assemble the front and rear stabilizer (4 & 2) to the main frame (1) with two screws (7) each.

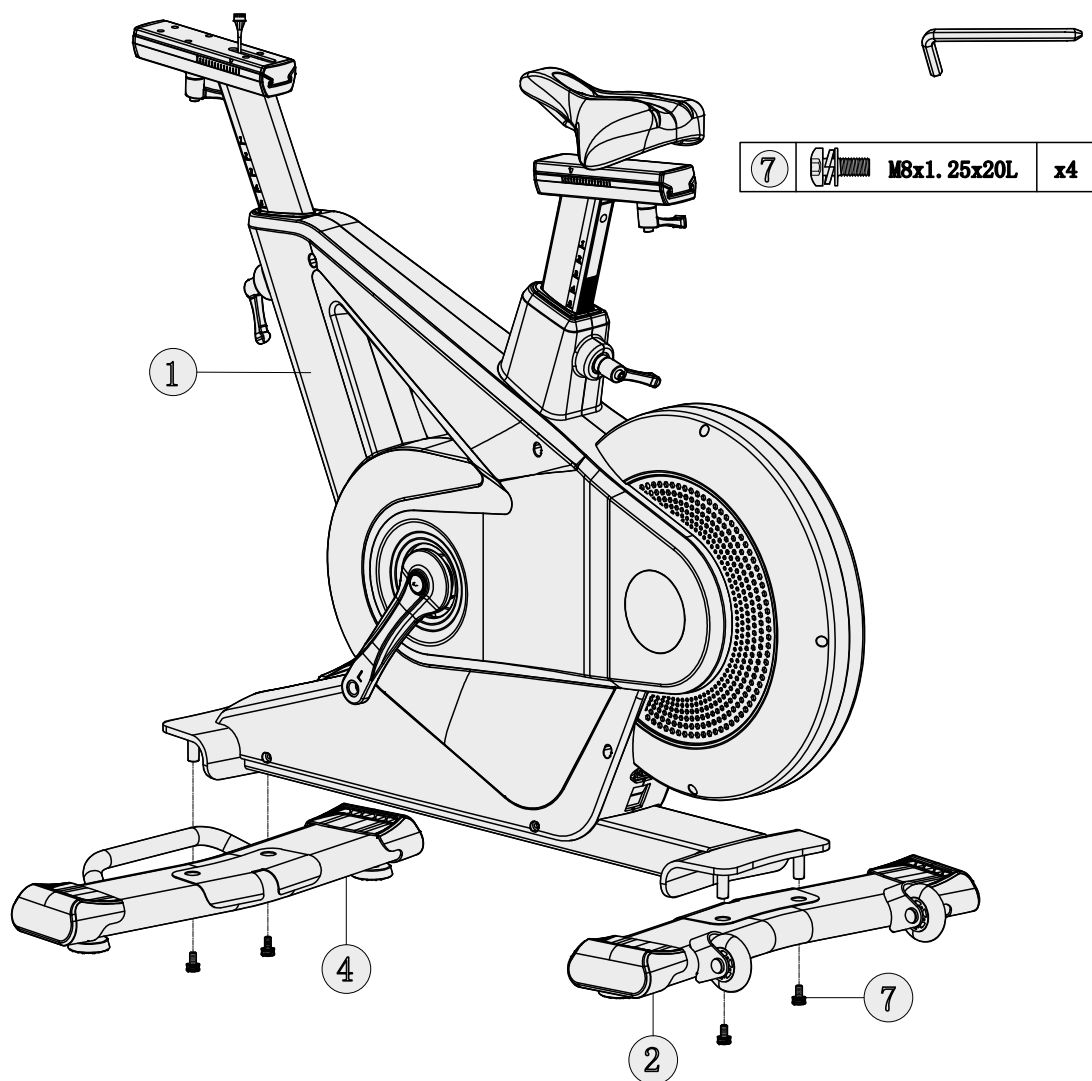

Step 2: Assembly of the Handlebar

1. Pass the middle computer cable (64) through the respective opening of the handlebar (36)

► **ATTENTION**

Be careful not to pinch the cables during the following step.

2. Assemble the handlebar (36) to the handlebar adjustable tube (17) with two screws (6), two spring washers (9) and two washers (16).

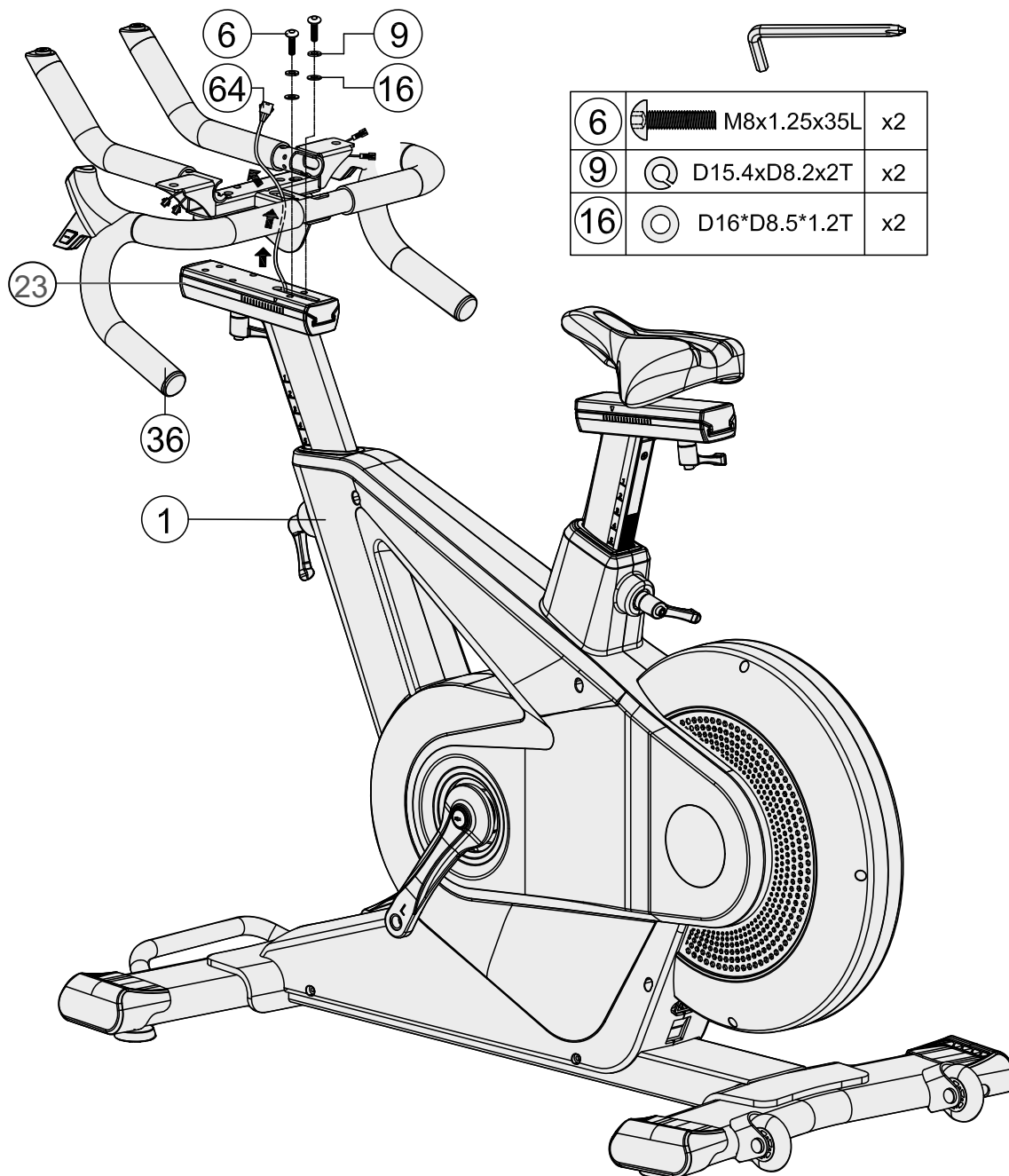

Step 3: Assembly of the Computer Supporting Tube

1. Connect the two left quick key cables (92L & 93L) to their corresponding counterparts (32L).
2. Connect the middle computer cable (64) to its corresponding counterpart (63).
3. Connect the two right quick key cables (92R & 93R) to their corresponding counterparts (32R).

► **ATTENTION**

Be careful not to pinch the cables during the following step.

4. Assemble the computer supporting frame (8) to the handlebar (36) with four bolts (6), four spring washers (9) and four flat washers (16).

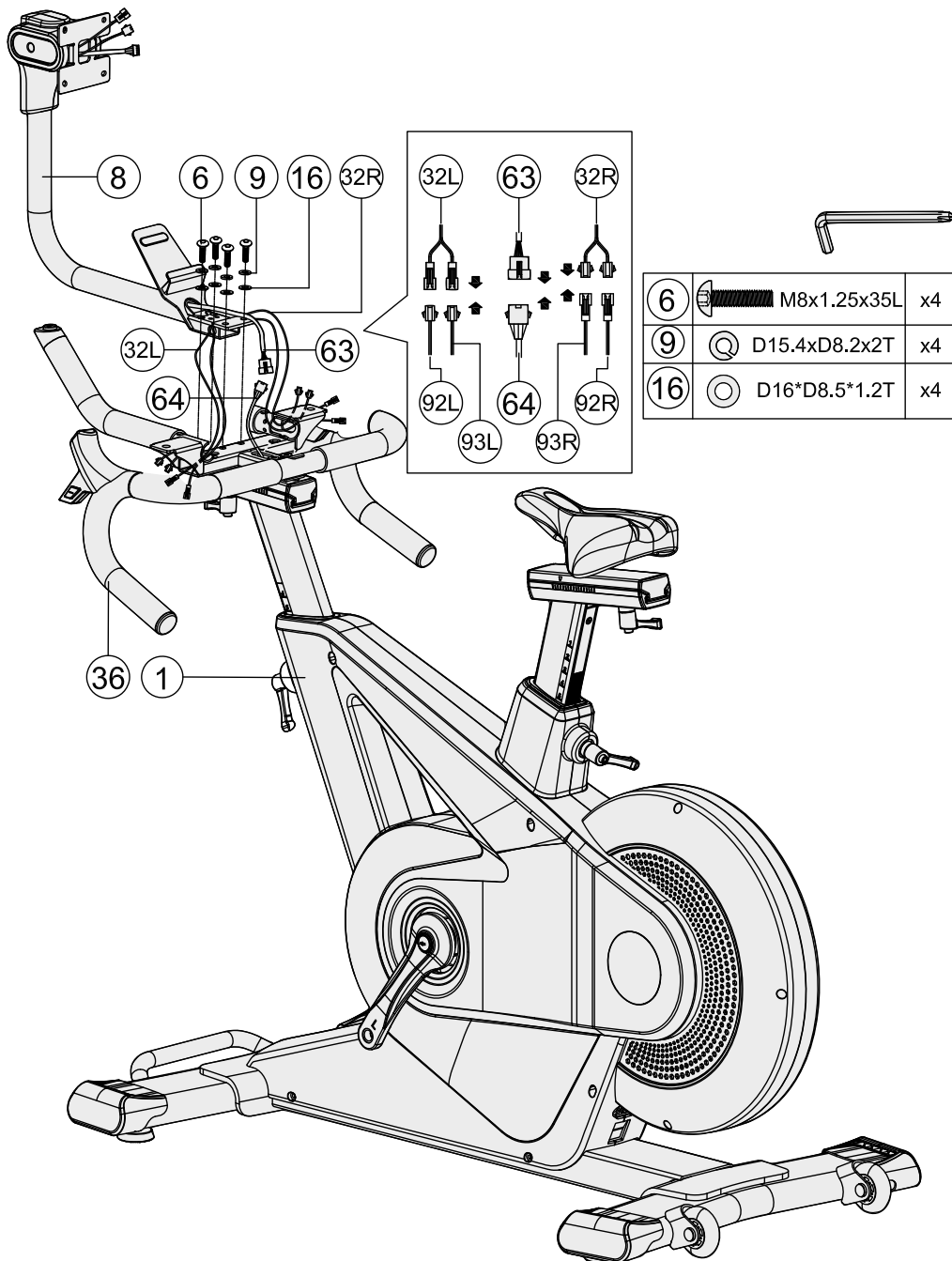

Step 4: Assembly of the Handbar Protective Cover

Assemble the handbar protective cover (43) to the handlebar (36) with two screws (37).

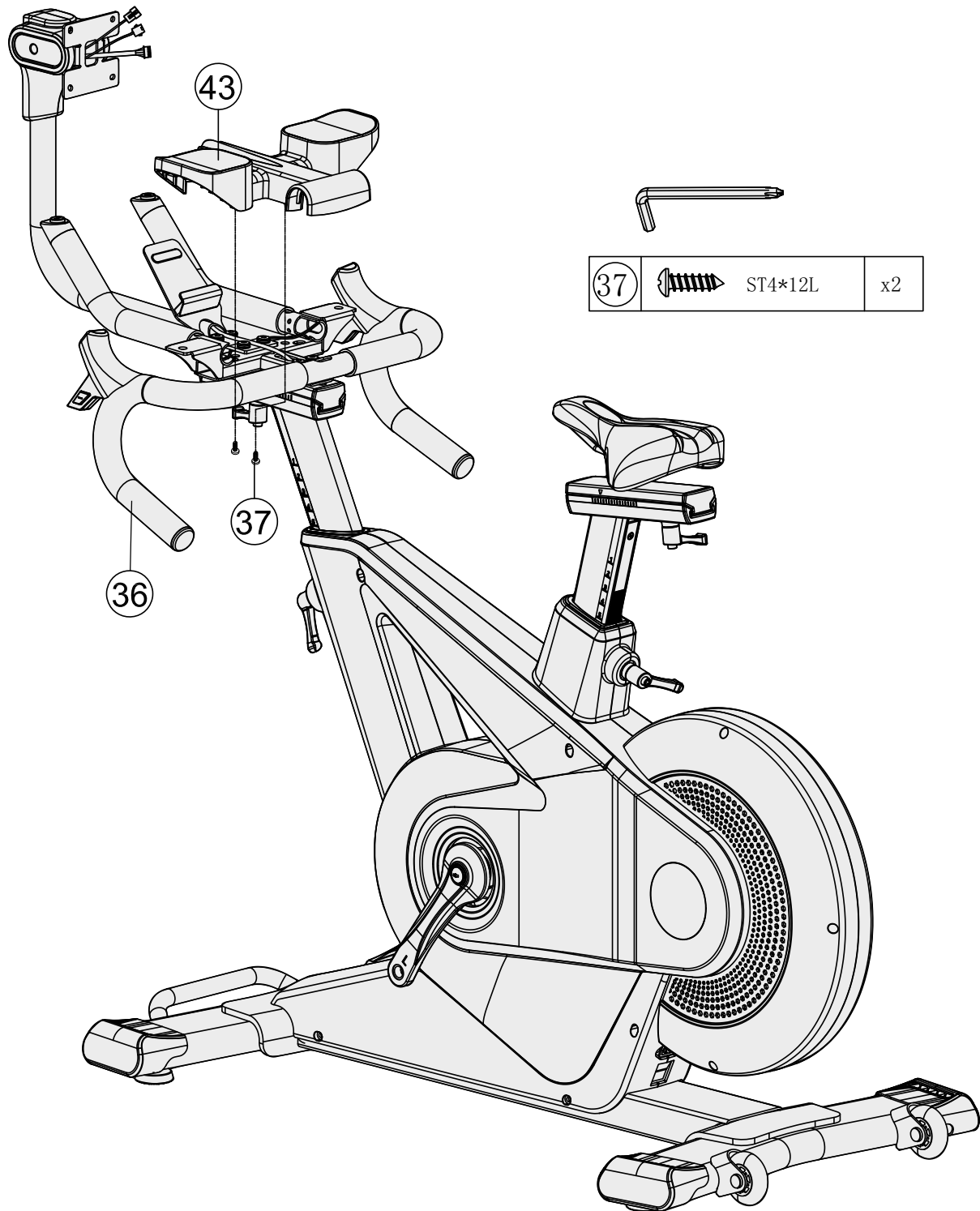

Step 5: Assembly of the Computer

1. Connect the left quick upper cable (32L) to their corresponding counterparts (76).
2. Connect the upper computer cable (63) to its corresponding counterpart (76).
3. Connect the right quick upper cable (32R) to their corresponding counterparts (76).

► **ATTENTION**

Be careful not to pinch the cables during the following step.

Assemble the computer (76) to the computer supporting tube (8) with four knurled hand screws (135).

4. Assemble the left and right handbar protective cover (42L & 42R) with three screws (37).

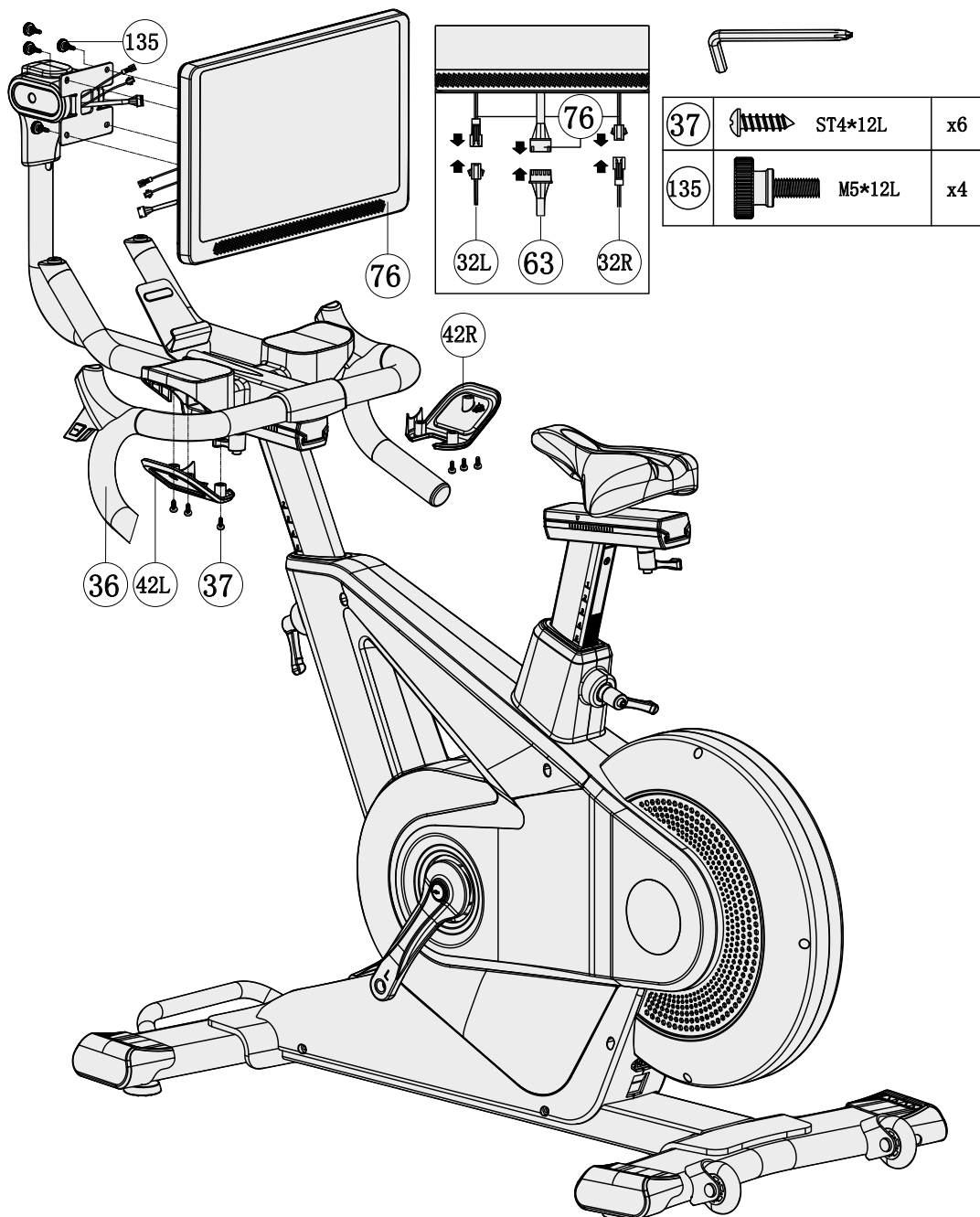

Step 6: Assembly of the Pedals and the Bottle holders

⚠ CAUTION

Make sure to screw in the pedals completely.

1. Mount the left pedal (51L) to the left crank arm (48L) with the tool by turning it counterclockwise.
2. Mount the right pedal (51R) on the right crank arm (48R) with the tool, turning clockwise.
3. Mount the left and right bottle holder (54L & 54R) to the handlebar (36) with two screws (7) each.
4. Now tighten all screw connections with the tool.

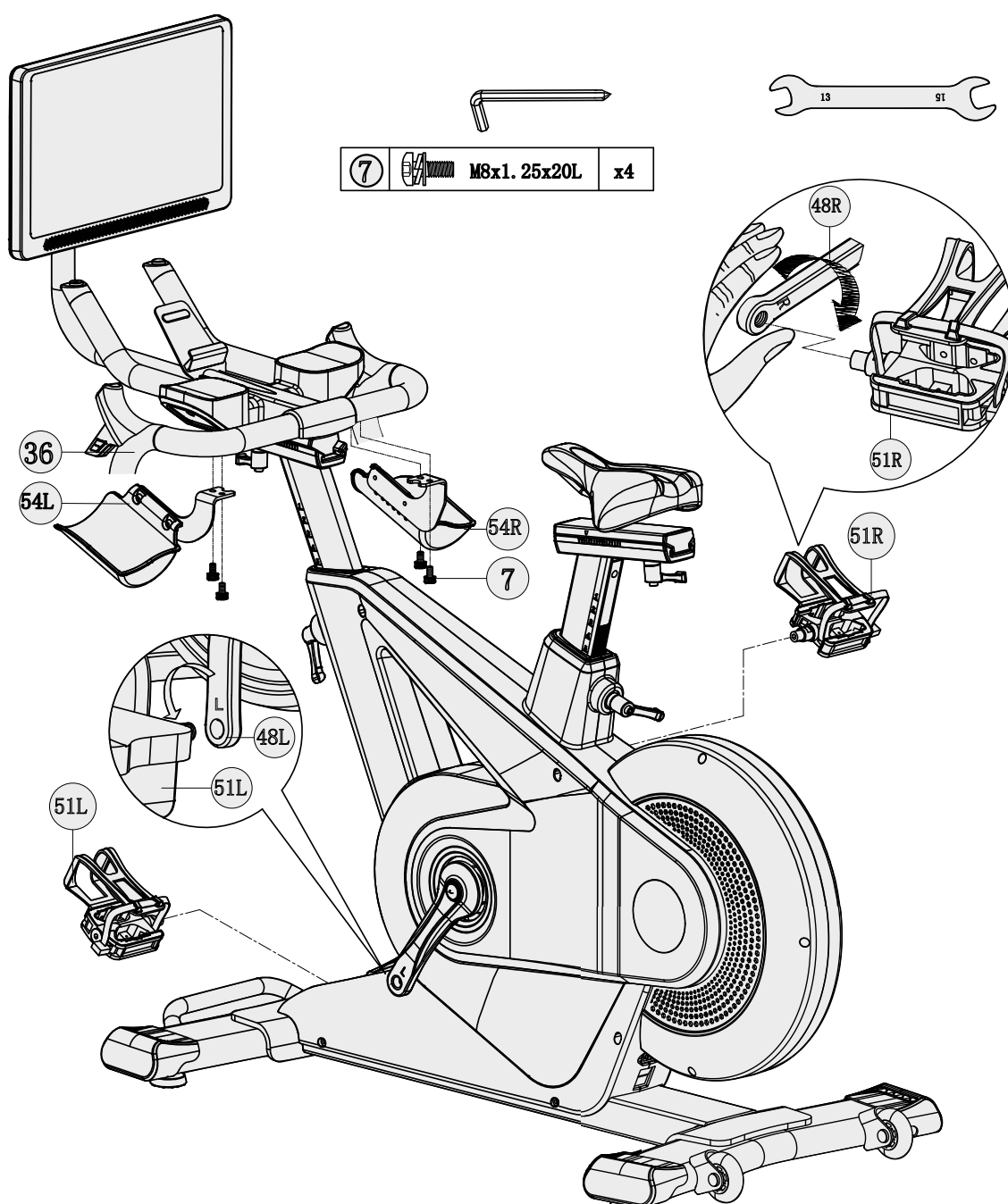

Step 7: Adjustment of the Seat

Height Adjustment

⚠ CAUTION

The seat post is marked with "STOP" for the minimum insertion depth. When adjusting, make sure not to exceed the minimum insertion depth.

1. Loosen and pull the L knob to adjust the height of the seat post.

⚠ CAUTION

In the following step, make sure the knob audibly engages in one of the adjustment holes.

2. Release the L knob.
3. Retighten the L knob.

Horizontal Adjustment

1. Loosen and pull the L knob underneath the seat until it can be moved forwards and backwards.
2. Move the seat into the desired position.

⚠ CAUTION

In the following step, make sure the knob audibly engages in one of the adjustment holes.

Release the L knob.

3. Retighten the L knob.

Tilt Adjustment (A-3)

1. Loosen the bolt connection underneath the seat until the tilt can be adjusted.
2. Adjust the desired tilt.
3. Retighten the bolt connection.

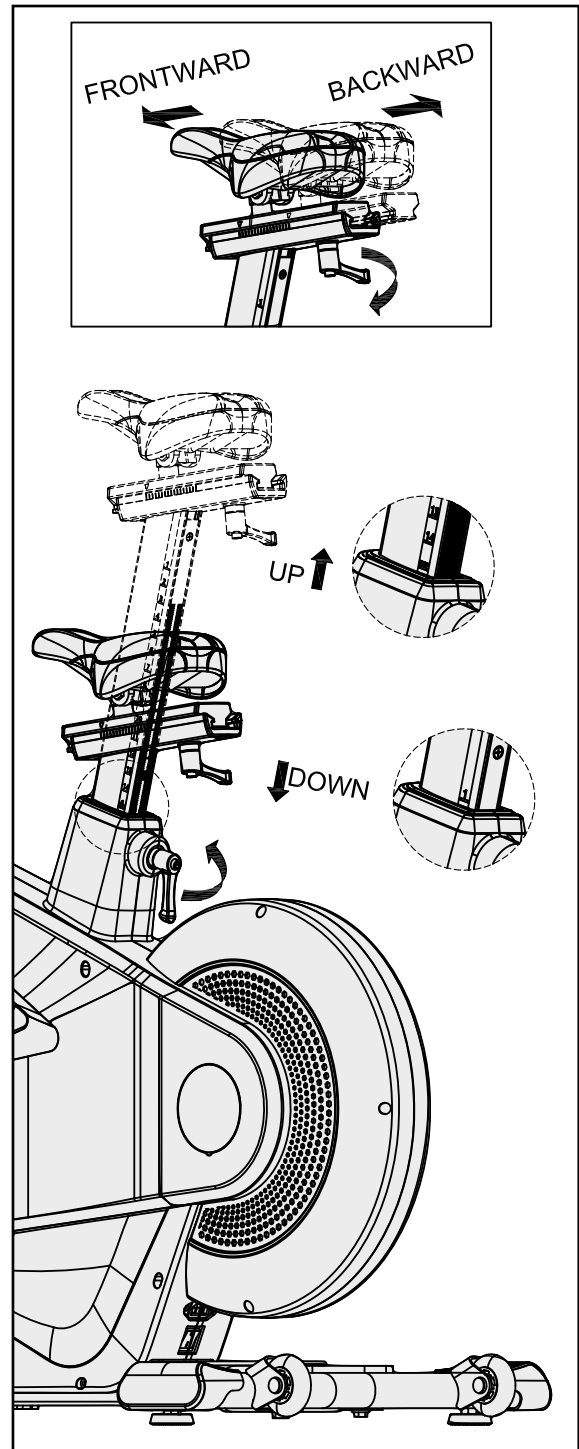

Step 8: Adjustment of the Handlebar

Height Adjustment

⚠ CAUTION

The front post is marked with "STOP" for the minimum insertion depth. When adjusting, make sure not to exceed the minimum insertion depth.

1. Loosen and pull the L knob to adjust the height of the front post.

⚠ CAUTION

In the following step, make sure the knob audibly engages in one of the adjustment holes.

2. Release the L knob.
3. Retighten the L knob.

Horizontal Adjustment

1. Turn the L knob to the left until the handlebar can be moved.
2. Adjust the handlebar into the desired position.
3. Retighten the L knob by turning it to the right.

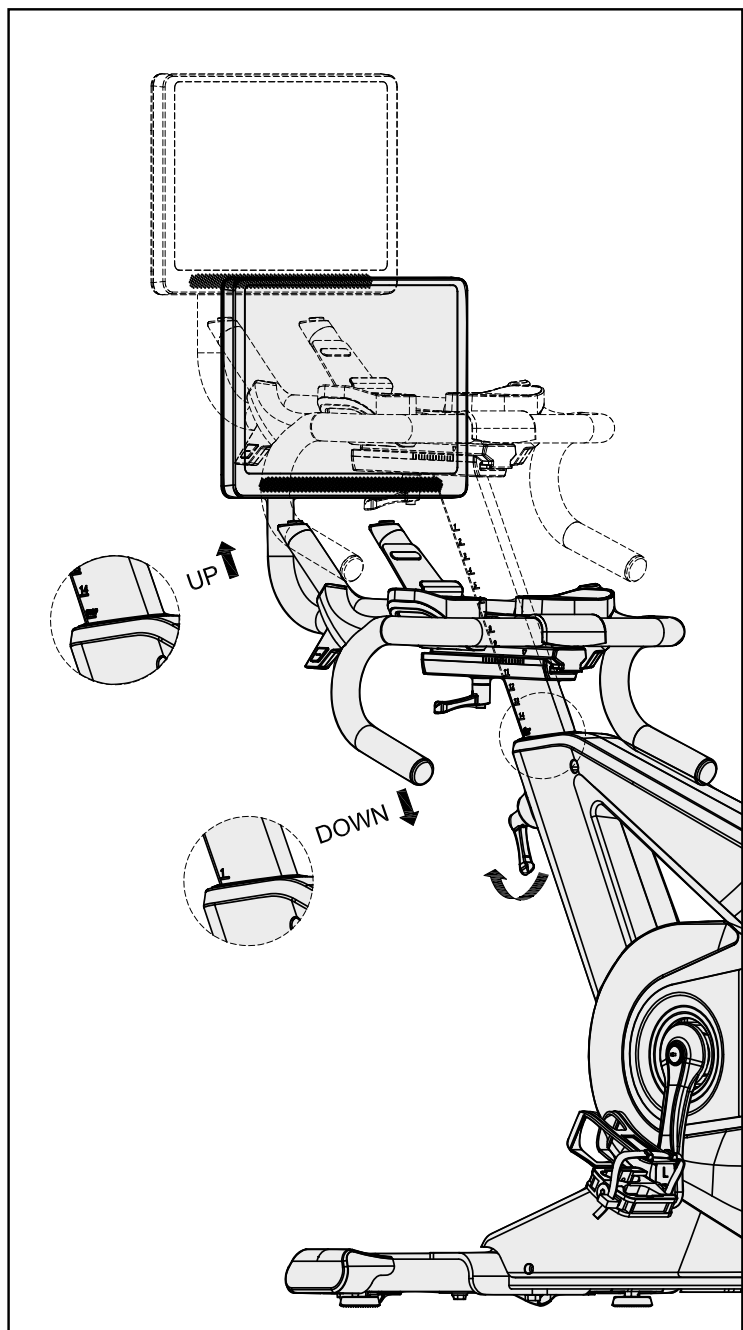
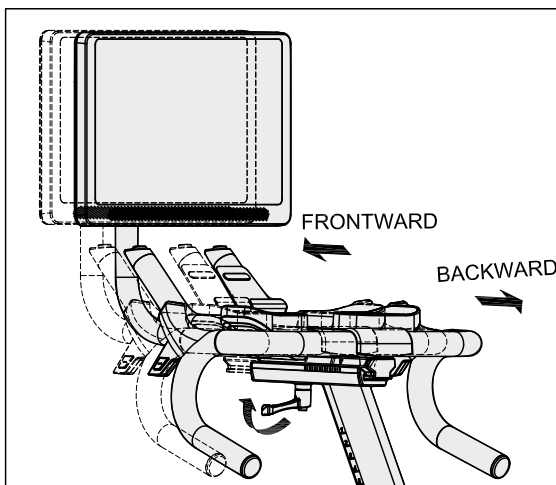

Step 9: Alignment of the Feet

If the floor is uneven, you can stabilize the equipment by turning the two setting screws under the main frame.

1. Lift the equipment on the desired side and rotate the setting screws under the main frame.
2. Rotate the screws clockwise in order to remove them and to raise the equipment.
3. Rotate them counterclockwise in order to lower the equipment.

Step 10: Connecting the Equipment to the Mains Supply

► **ATTENTION**

The equipment must not be connected to a multiple socket, otherwise it cannot be guaranteed that the equipment will be supplied with sufficient power. Technical errors can result.

Plug the power plug into a wall outlet that complies with the instructions in the chapter on electrical safety.

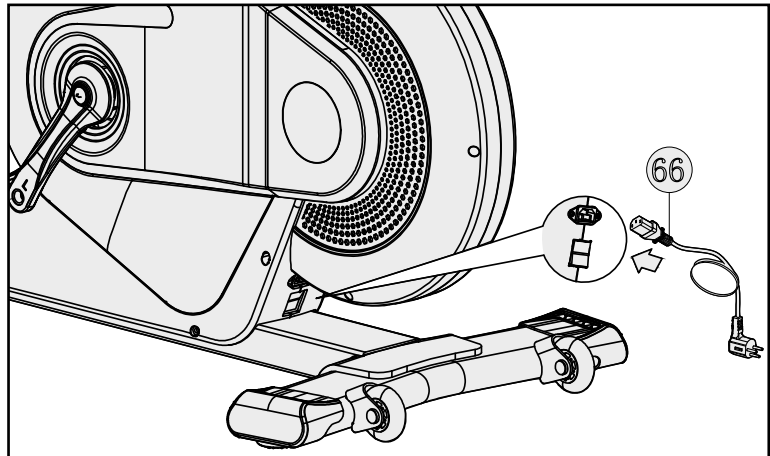

Correctly Getting On and Off

1. To get on, grip the handles with both hands and first step onto the left pedal with your left foot or onto the right pedal with your right foot and then place your foot onto the other pedal.
2. To get off, grip the handles with both hands and place one foot next to the equipment and then the other foot.

3 OPERATING INSTRUCTIONS

① NOTICE

- + Familiarise yourself with all the functions and setting options of the device before starting training. Have the proper use of this product explained to you by a specialist.
- + Always start your training with low intensity and increase evenly and gently. End your training with a cool-down phase. If you are unsure, please consult your physician.

3.1 Console Display









TIME	+ Display of the training time + Display range 0:00 - 99:99
SPEED	+ Display of the current speed
DISTANCE	+ Display of the training distance + Display range 0 - 99.9 km or mi
CALORIES	+ Display of the calorie consumption + Display range 0 - 9990 kcal
Heart Rate	+ Display of the current heart rate + Display of the heart rate + Display range 0 - 230 ① NOTICE This equipment does not have hand pulse sensors. To measure the heart rate, a chest strap is required.
WATT	+ Display of the Watt value + Display range 0-999

HR Zone	<ul style="list-style-type: none"> + Display of the heart rate zones + Display range very light, light, moderate, hard, maximum
BAI	<ul style="list-style-type: none"> + Display of the BAI consumption + Display range 0 - 999 <p>ⓘ NOTICE Body Activity Intelligence (BAI) is a universal and consistent metric that applies to all ages and genders. It evaluates whether your physical activity and training are sufficient for improving your overall health and physical condition.</p>
RPM	<ul style="list-style-type: none"> + Display of the current revolutions per minute (RPM) + Display range 0 - 999

3.2 Button Functions

Start/Pause:	+ Tap to start and/or pause the training
Stop	+ Tap to stop the training
Up	+ Tap to increase a value
Down	+ Tap to decrease a value

3.3 Further Functions

	Settings	Here you will find all setting options.
	Volume	Here you can adjust the volume.
	Brightness	Here you can adjust the brightness.
	Timezone	Here you can adjust the date or the current time zone.
	Wifi	Here you can connect the console to a wifi network.
	Heart Rate	Here you can connect the console to a chest strap.
	Multimedia	Here you can access different media: Netflix, Youtube, Spotify, Kinomap, Firefox, Facebook, Twitter Instagram

3.4 Programmes

There are a variety of programmes available to you. These include

- + Quick Start programme: 1
- + Target programme: 1
- + Pre-set programmes: 12
- + Interval programme: 1
- + Heart rate programmes: 4
- + Watt programme: 1

You can also set your own virtual training routes via Google Maps.

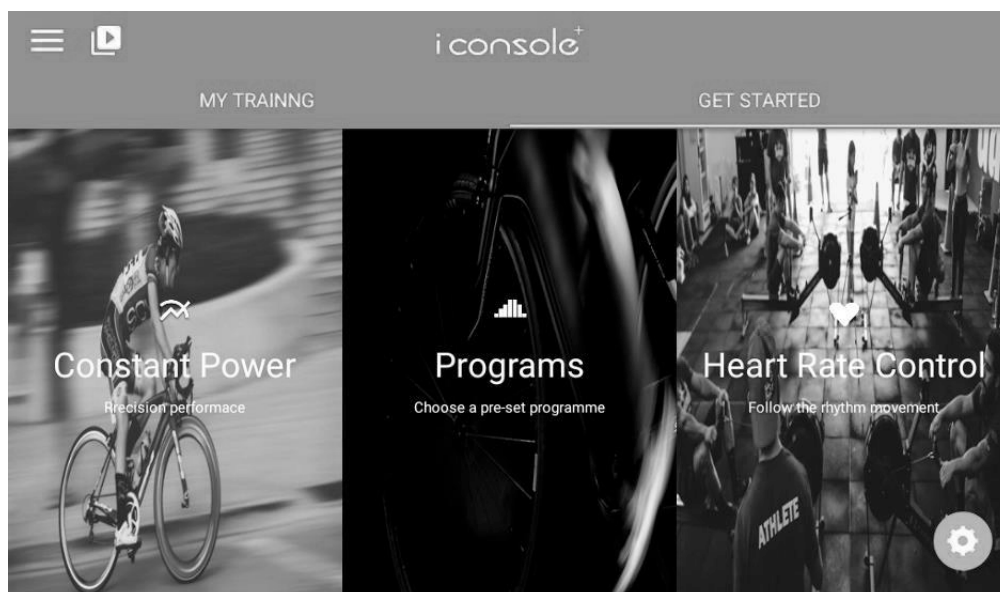
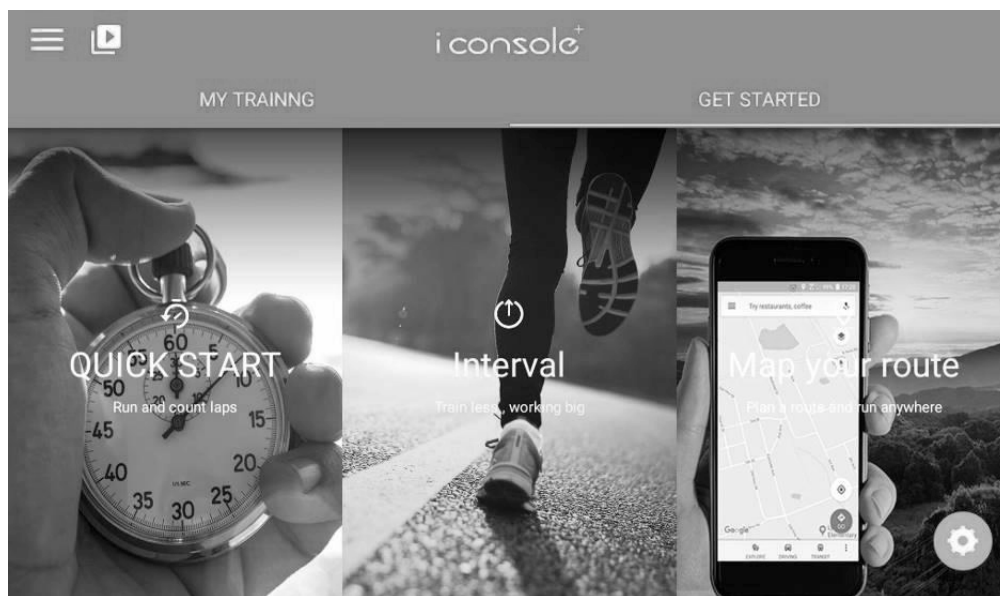

3.4.1 Quick-Start Programme/Target Programme

1. Tap QUICK START in the main menu.
2. Set the values for the desired distance, time and/or calories for your training.

① NOTICE

You can set one or more parameters. The set values are counted down to 0, the others are counted up accordingly.

3. To start the training, tap START.

You can manually adjust the resistance during the workout.

4. To pause the training, tap PAUSE.
5. To stop the training, tap STOP.

→ *When the training is finished, a summary of the recorded training parameters is displayed.*

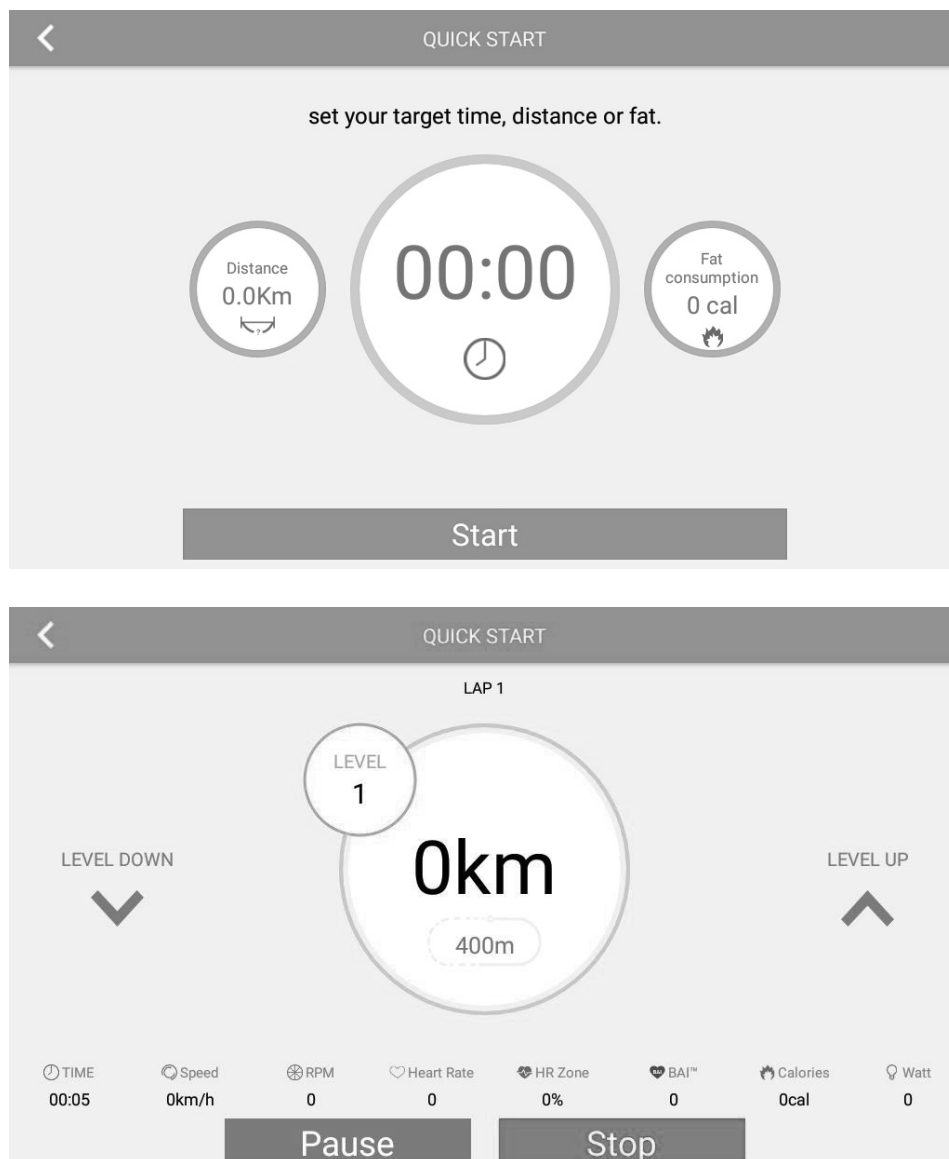

3.4.2 Pre-set Programmes

1. Tap PROGRAMS in the main menu.
2. Set the desired training time.
3. Select one of the 12 pre-set programmes.
4. To start the training, tap START.

You can manually adjust the resistance during the training.

5. To pause the training, tap PAUSE.
6. To stop the training, tap STOP.

→ *When the training is finished, a summary of the recorded training parameters is displayed.*

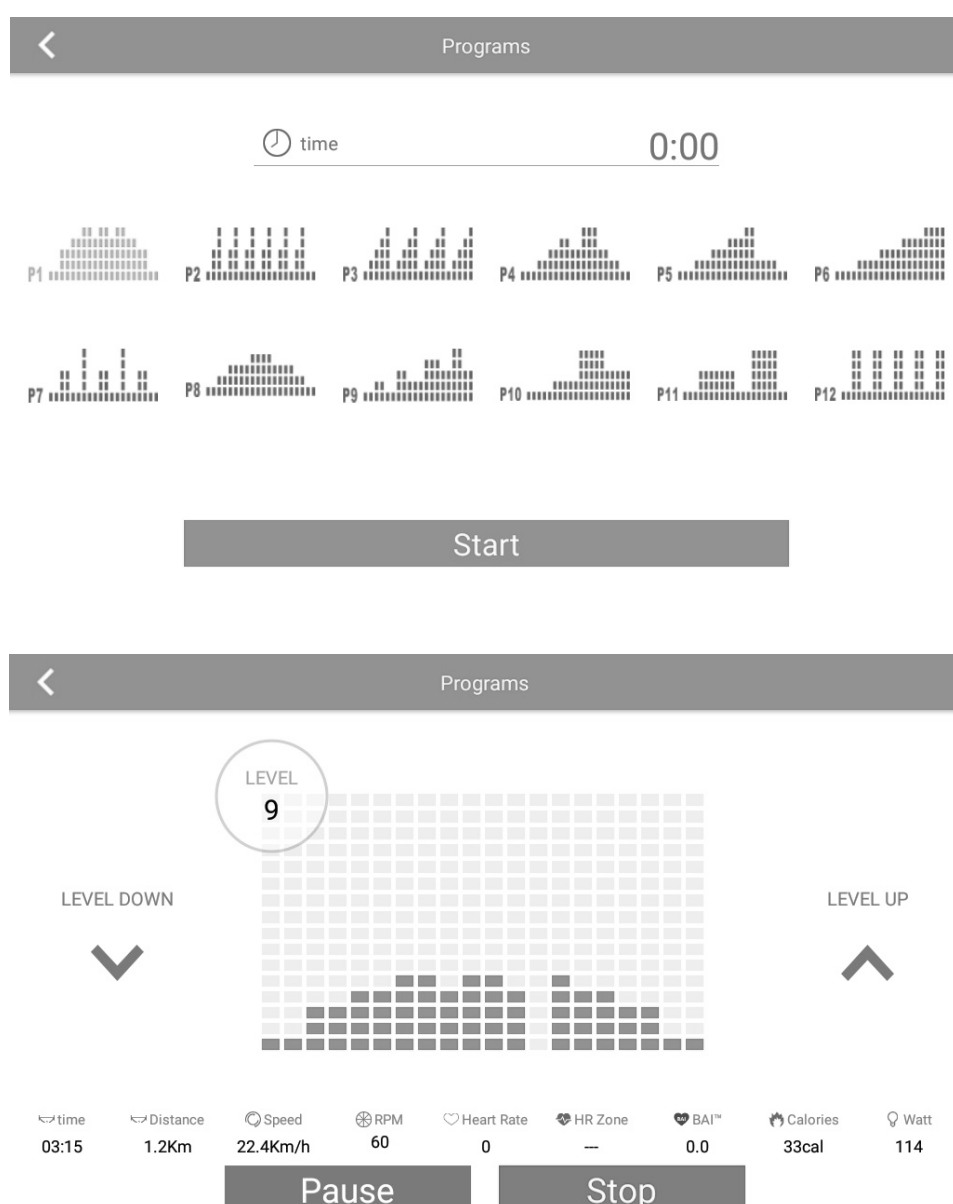

3.4.3 Interval Programme

1. Tap INTERVAL in the main menu.
2. Set the values for the desired number of cycles, time, resistance and revolutions per minute for your workout.
3. To start the training, tap START.

The workout starts with a 1-minute warm-up.

You can manually adjust the resistance during the training.

4. To pause the training, tap PAUSE.
5. To stop the training, tap STOP.

→ *When the training is finished, a summary of the recorded training parameters is displayed.*

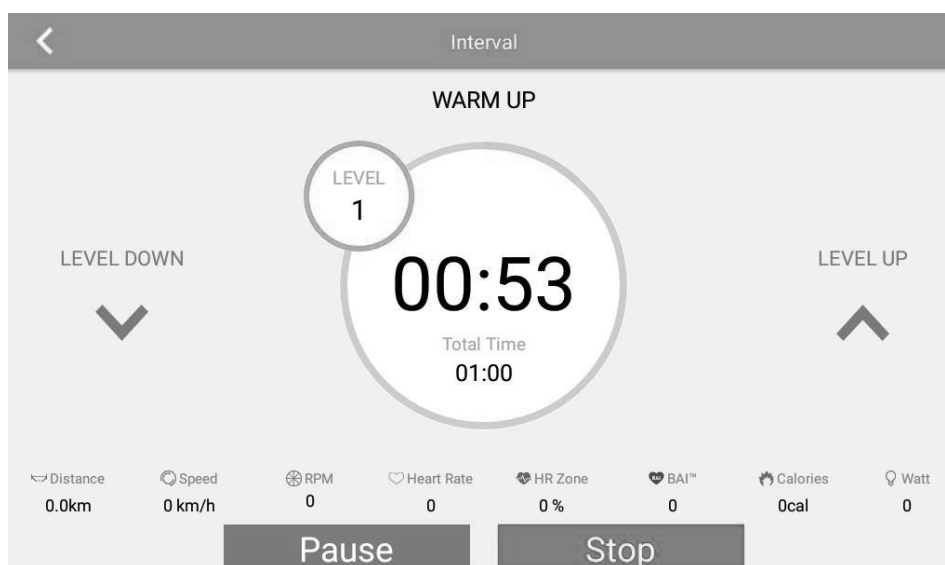
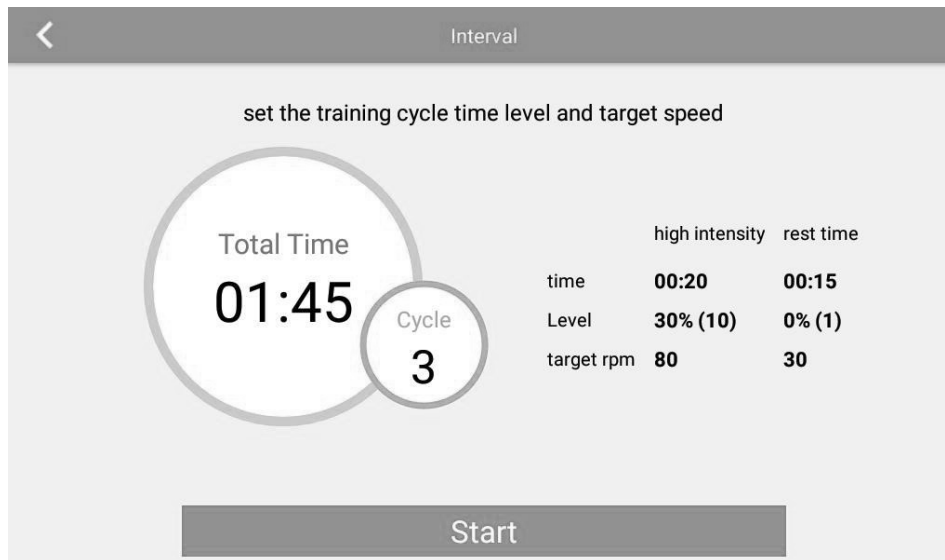

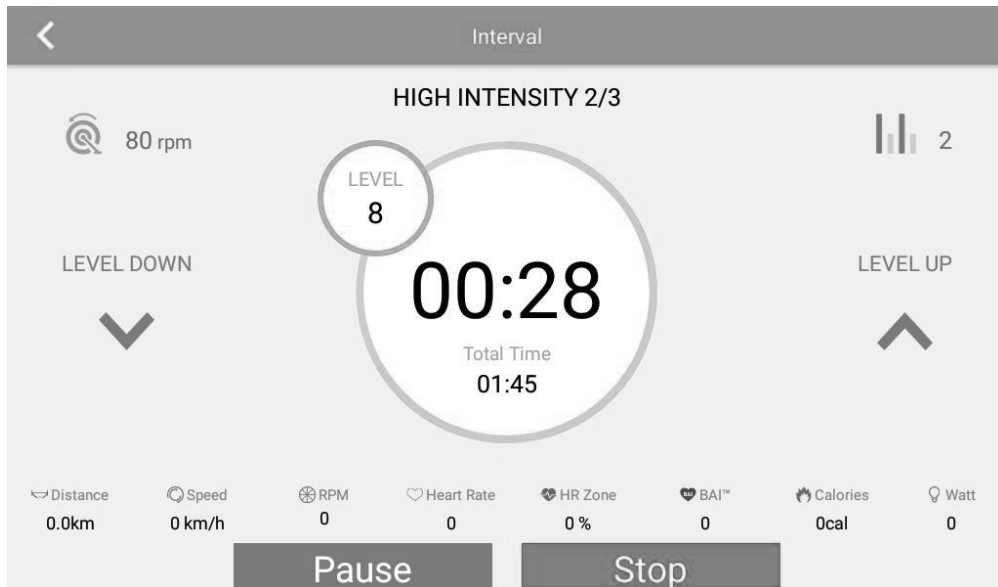

3.4.4 Heart Rate Controlled Programmes

⚠ WARNING

Your training equipment is not a medical device. The heart rate measurement of this equipment may be inaccurate. Various factors can affect the accuracy of the heart rate measurement. The heart rate measurement serves only as a training aid.

ℹ NOTICE

For this programme, a chest strap is required.

You can choose between three preset heart rate programmes and one programme, where you individually set a pulse value (55 %, 75 %, 90 % of your max. pulse and TAG PULSE).

In the heart rate programmes, the resistance is automatically adjusted depending on your heart rate. Your maximum heart rate is determined by the console depending on your entered age.

1. Tap HEART RATE CONTROL in the main menu.
2. Enter your age and the desired training time.
3. Select either 55%, 75%, 90% or Target Pulse.
 - 3.1. If you selected Target Pulse, now set the desired pulse value.
4. To start the training, tap START.

The resistance is adjusted according to your heart rate. The resistance cannot be adjusted manually.

ℹ NOTICE

If the console does not receive a pulse signal for 30 seconds, the programme will automatically stop.

5. To pause the training, tap PAUSE.
6. To pause the training, tap STOP.

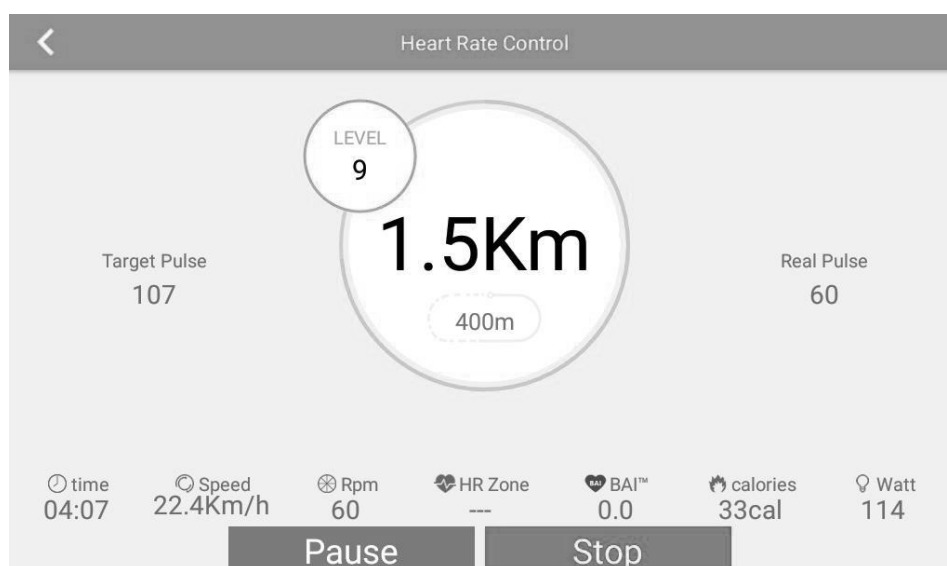
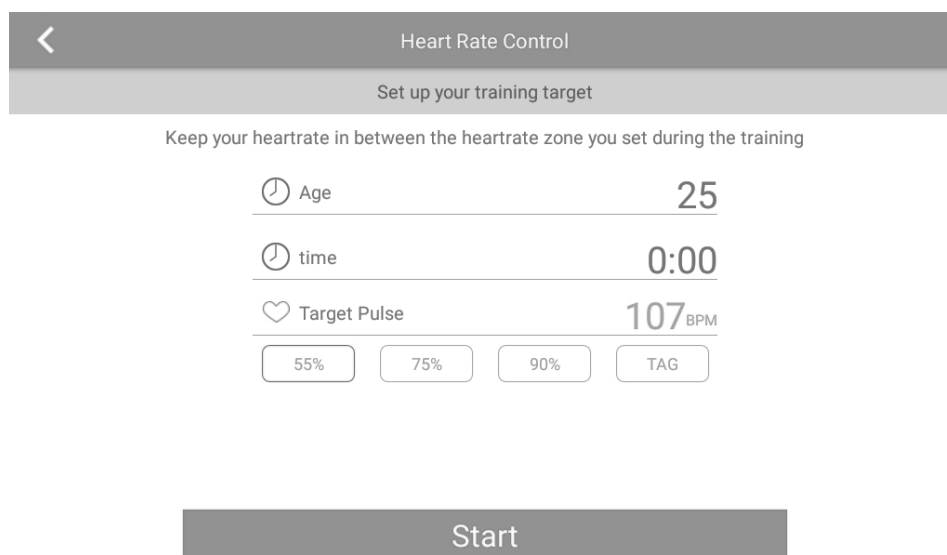

→ When the training is finished, a summary of the recorded training parameters is displayed.



3.4.5 Watt Programme

1. Tap CONSTANT POWER in the main menu.
2. Set the values for the desired training time, target wattage and target cadence for your training.
3. To start the training, tap START.



The resistance level is automatically adjusted according to the wattage you set.

4. To pause the training, tap the following icon .
5. To stop the training, tap the following icon .

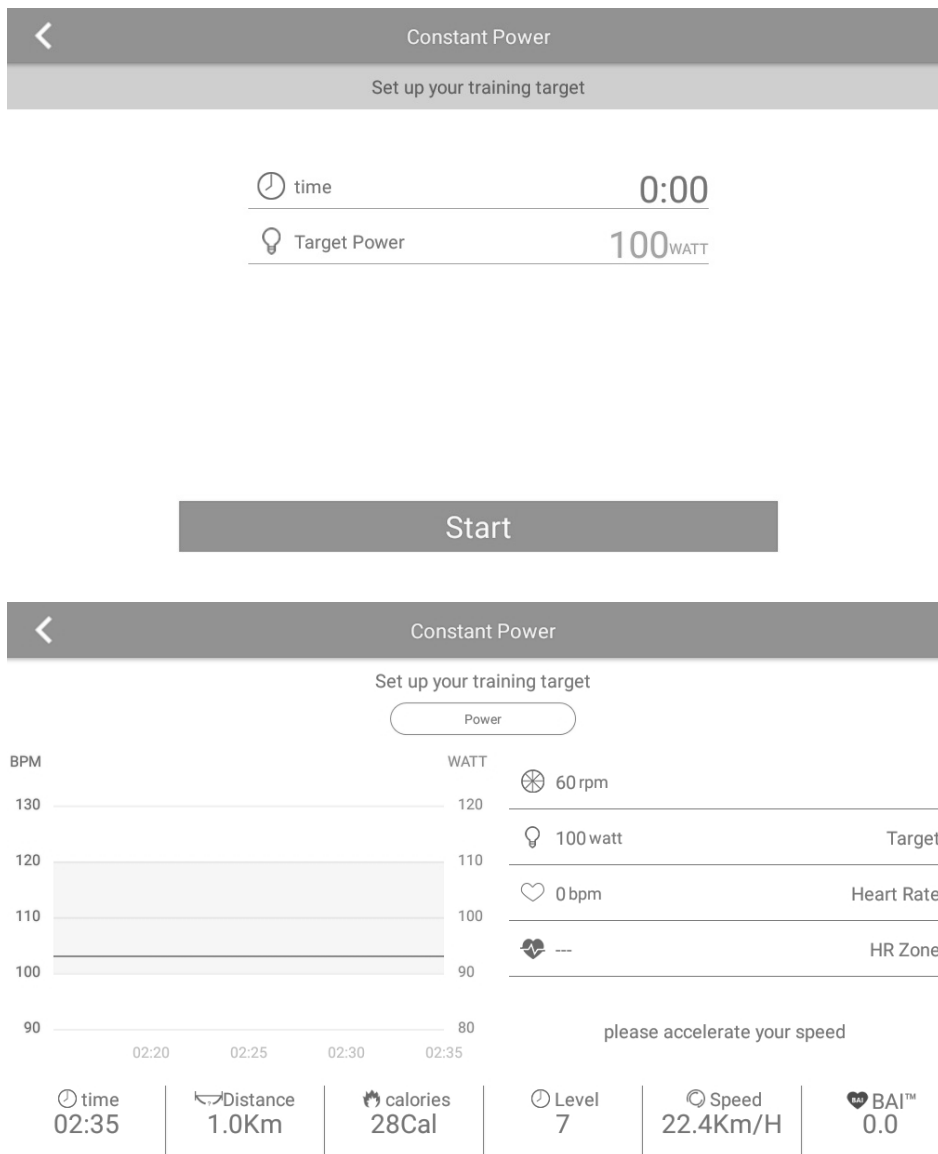
→ When the training is finished, a summary of the recorded training parameters is displayed.









3.4.6 Virtual Training Routes



1. Tap MAP YOUR ROUTE in the main menu.
2. After you have started this mode, you must determine your current position. To do this, tap the following icon .
3. To switch to the worldwide Google Maps view, tap the following icon .

NOTICE

If you are within China, you can also select the default region by tapping the following icon .

4. Select your start position and tap until the following icon appears .
5. Select your end position and tap it again until the following icon appears .
6. If desired, select one or more stopovers on your route and tap a third (or correspondingly more) time(s) until the following icon appears .
7. To cancel your selection, tap the following icon .
8. To start the training, swipe the following icon from left to right .
9. To show or hide the training parameters, tap the following icon .
10. To switch between the map view, Google Street View and the satellite view, tap the following icon .

The resistance level is automatically adjusted according to the condition of the track. Alternatively, you can adjust the resistance level manually during the workout.

11. To pause the training, tap the following icon .
12. To end the training, tap the following icon .

→ *When the training is finished, a summary of the recorded training parameters is displayed.*

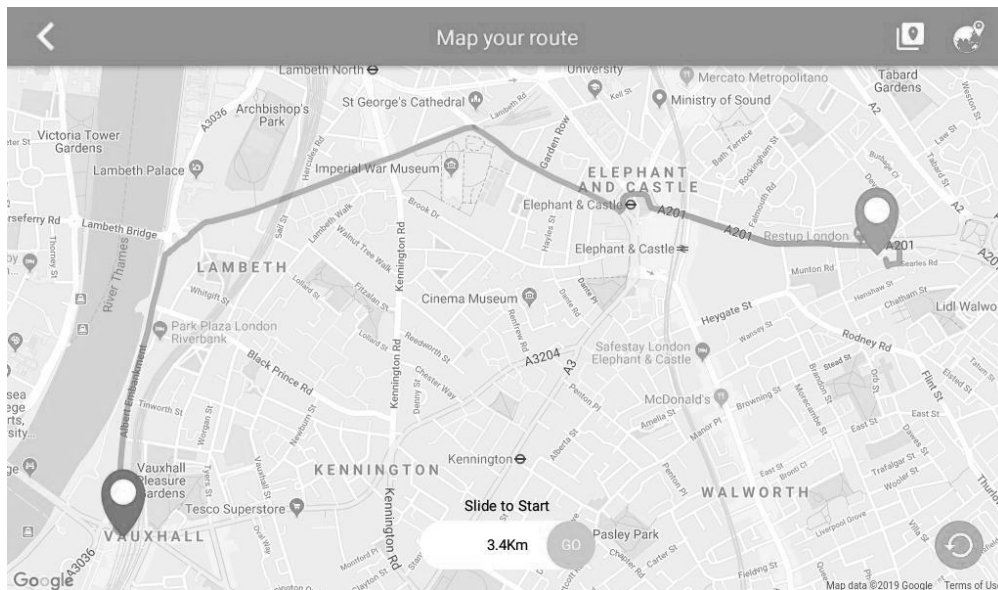
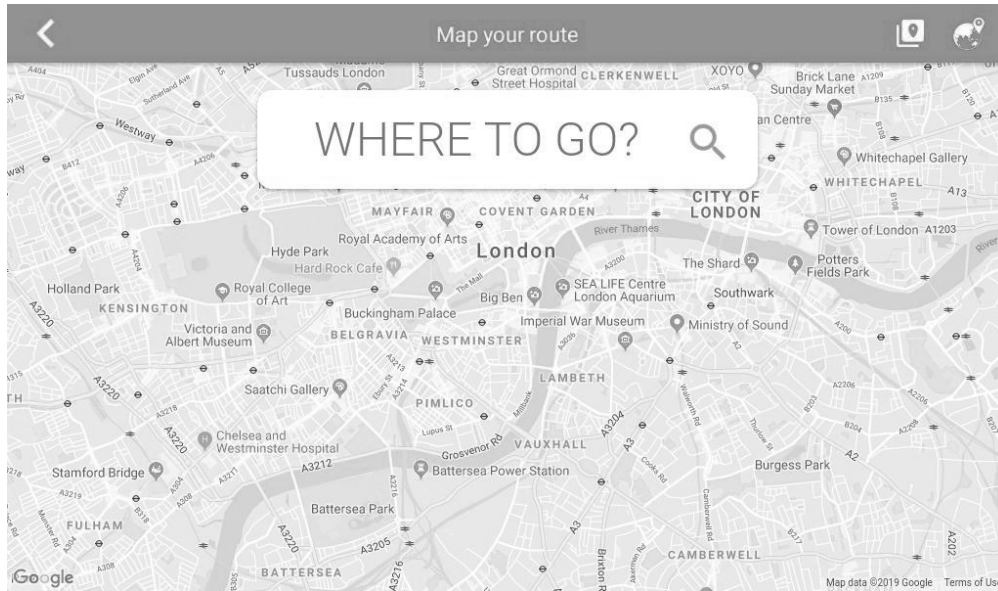

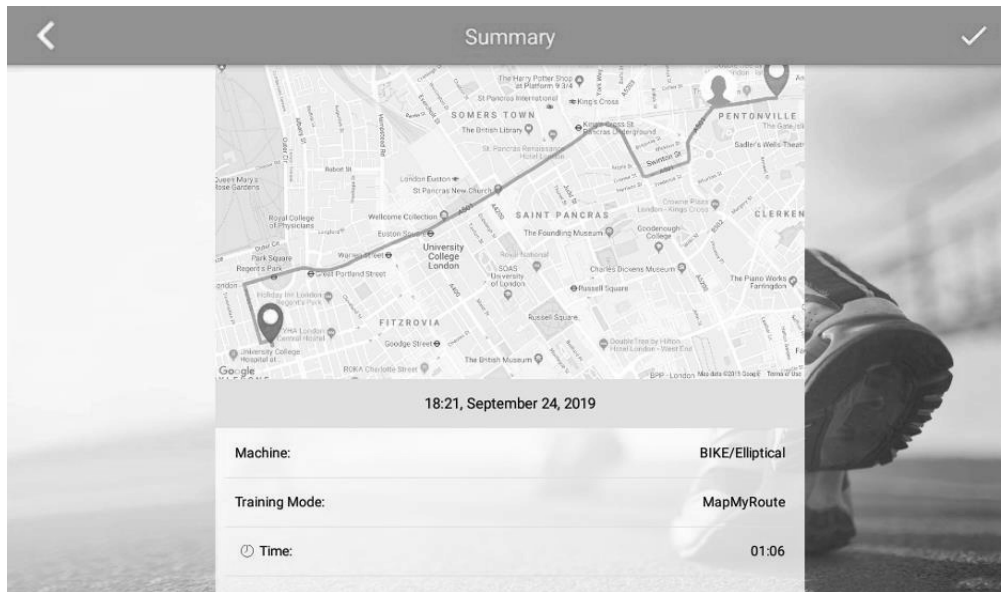
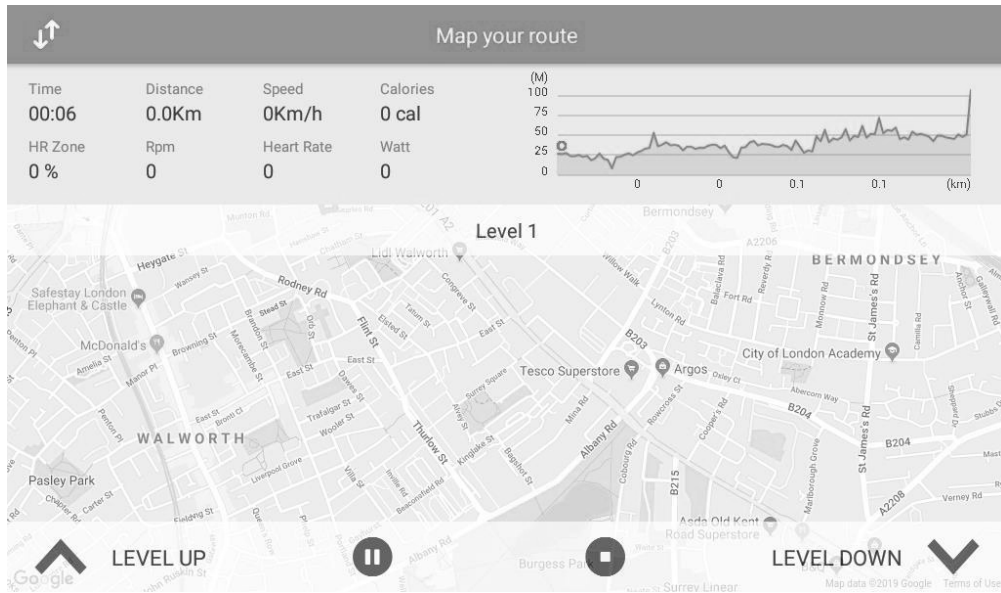

3.5 Multimedia and Software Updates

► ATTENTION

Check your TFT-console regularly for possible software updates. If available, make sure to carry out the updates soon. If the updates are not carried out over a longer period of time, this can lead to technical problems with the console.

To make sure the pre-installed apps are working correctly, they must be updated regularly as well. Follow the instructions on the screen to perform the updates.

Please note: The system is set up only for the pre-installed apps. Do not install any additional apps as their proper functionality can not be guaranteed. The installation of other apps might cause technical issues.

ⓘ NOTICE

- + The pre-installed apps are produced and provided by external manufacturers. Changes and availability within these apps might occur. Fitshop does not take any responsibility and can not be held liable for the availability, functionality or contents of these apps.

There are a variety of apps available to you. These include:

- + Netflix
- + Youtube
- + Spotify
- + Kinomap
- + Internet browser
- + Facebook
- + Twitter
- + Instagram

You can access all of the above apps during training. You can show or hide the training parameters by tapping the following icon .

To return to the main menu, tap the following icon .

To go back one page within the apps, tap the following icon .

To start the training, tap the following icon .

To stop the training, tap the following icon .

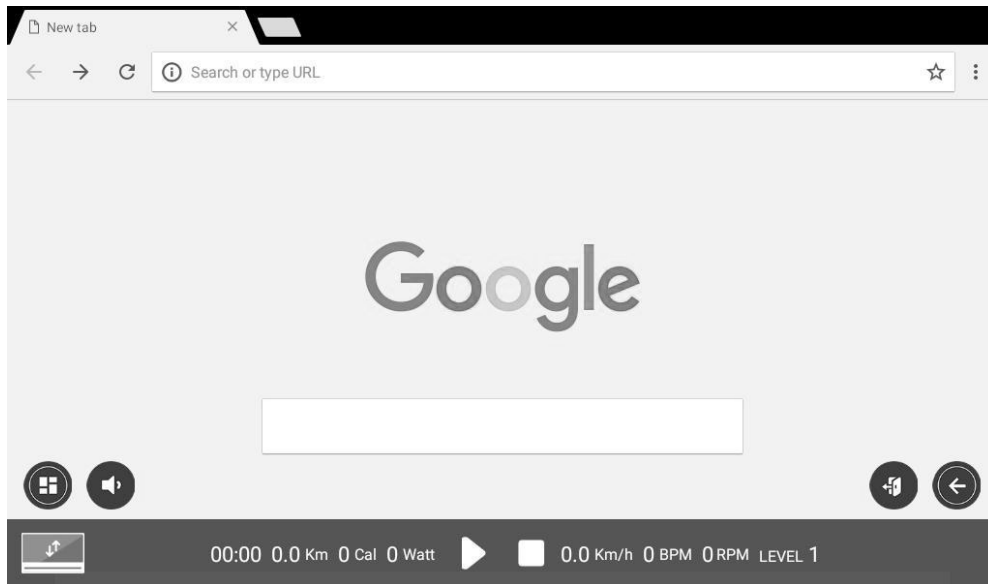

Example of an app

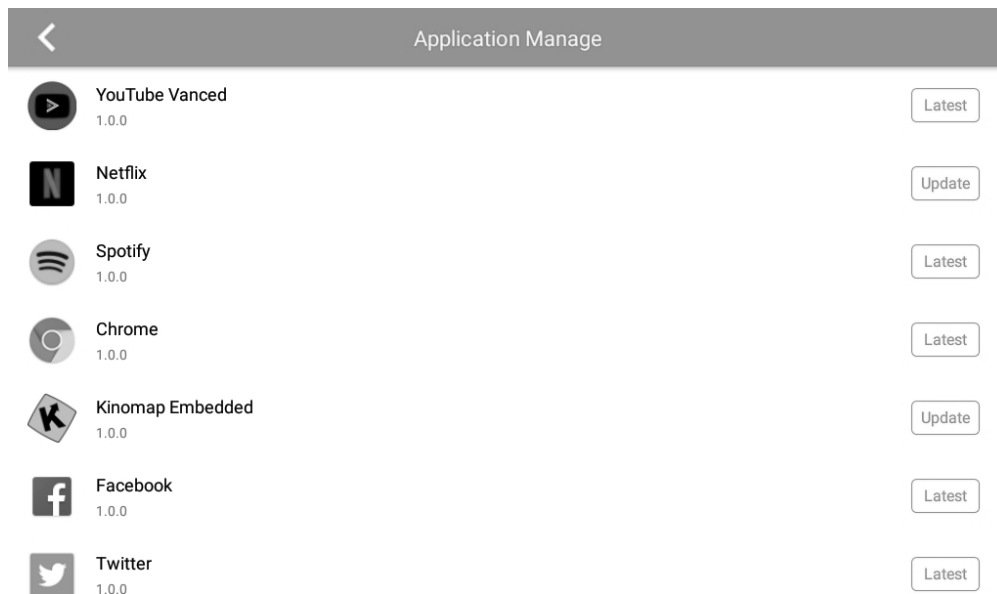

Overview of apps and possible software updates

3.6 Compatibility Training Apps

This indoor cycle is equipped with a wireless technology interface which allows you to connect the console to different training apps via your mobile device such as smartphone or tablet. You can find and download the training apps in the app stores of Google or Apple.

i NOTICE

- + Make sure that FTMS is always turned on when connecting the console to third-party apps. It can otherwise result in malfunctions of the apps.

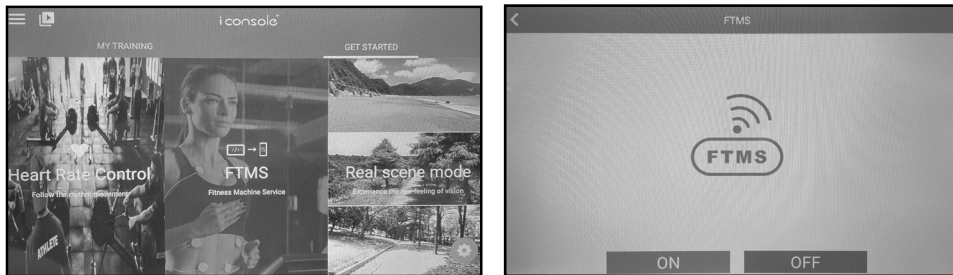

- + Your mobile device must be compatible with the wireless technology interface of the indoor cycle.
- + Make sure that wireless technology is activated on your mobile device and that the console is active. To activate the console, simply tap any button.
- + Third-party apps are produced and provided by external manufacturers. Changes and availability of these apps may occur and/or differ. Fitshop holds no responsibility for the availability, functionality or content of these apps.
- + Paid subscriptions may be required for the access and/or full functionality of the training apps.

Your fitness equipment is compatible with several training apps. These include:

- + Kinomap
 - + iConsole+
 - + ZWIFT
1. Make sure that wireless technology is activated on your mobile device and the console of the indoor cycle is active.
 2. Open the training app.
 3. Select your fitness equipment. You can find the name on a small sticker on the back of the console.
 4. Follow the instructions given in the app.

3.6.1 Connection with Kinomap

i NOTICE

- + Please note that a paid subscription is required for the full functionality of Kinomap.
- + Third party apps are produced and provided by external manufacturers. Changes and availability within these apps might occur. Fitshop does not take any responsibility and can

not be held liable for the availability, functionality or contents of these apps.

- + Make sure wireless technology is enabled on your mobile device and the console is active. Otherwise, simply tap any button.

1. Open Kinomap on your mobile device.
2. On the main screen, select "More" in the bar at the bottom.
3. Now select "Device management" on this page. Currently connected devices are displayed here.
4. To add a new device, tap the "+" at the top right.

ⓘ **NOTICE**

There may be slight differences in menu navigation between Android and iOS operating systems.

5. Now select the type of device. You can choose from roller trainer, exercise bike, treadmill, cross trainer, indoor cycle and rowing machine. For the Taurus Racer, select Indoor Cycle.
6. On the next page you will see the different brands. Select "Taurus" and then the Taurus Racer.
7. Now all wireless technology sources in the surrounding area are displayed. Select a wireless technology source that begins with i-Console The number that follows is also written on a small sticker on the back of the console.

The device is now added.

8. Return to the main menu, select a track and enjoy a great track video.

4.1 General Instructions

⚠ WARNING

- + The storage location should be chosen so that improper use by third parties or children can be prevented.
- + If your equipment does not have transportation wheels, the equipment must be disassembled before transportation.

▶ ATTENTION

- + Make sure that the equipment is protected from moisture, dust and dirt in the selected storage location. The storage location should be dry and well ventilated and have a constant ambient temperature between 10°C and 35°C.

4.2 Transportation Wheels

▶ ATTENTION

If you want to transport your equipment over particularly sensitive and soft floor coverings, such as parquet, planks or laminate, lay out the transport route with cardboard or similar to avoid possible floor damage.

1. Stand behind the equipment and lift it until the weight is transferred to the transportation wheels. After that, you easily can move the equipment to a new position. For long transport distances the equipment should be disassembled and safely packed.
2. Select the new location by following the instructions in the section of this manual.

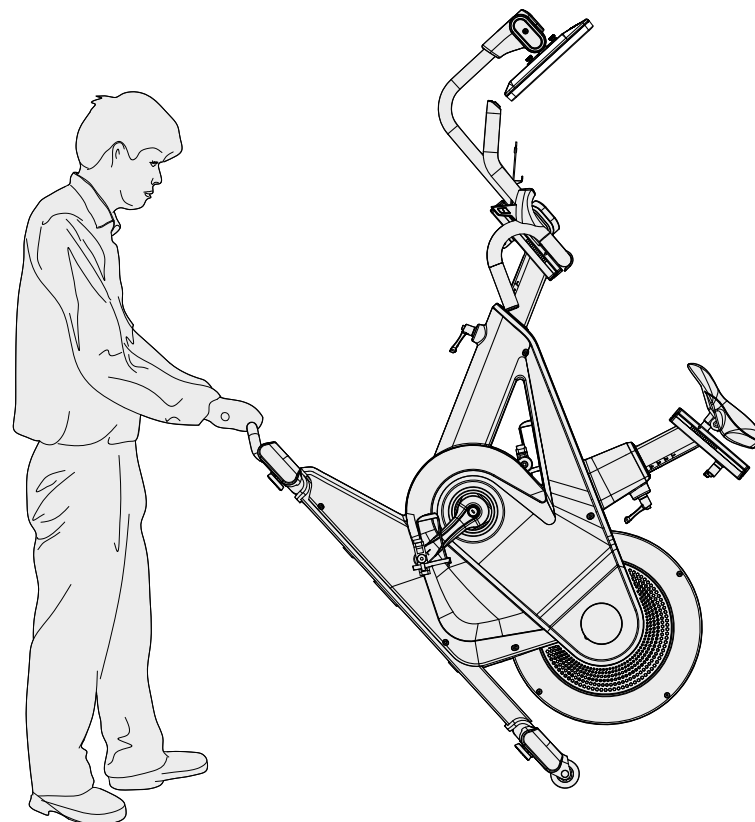

5.1 General Instructions

⚠ WARNING

- + Do not make any improper changes to the equipment.

⚠ CAUTION

- + Damaged or worn components may affect your safety and the life of the equipment. Therefore, immediately replace damaged or worn components. In such a case, contact the contract partner. The equipment must not be used until it has been repaired. If necessary, use only original spare parts.

▶ ATTENTION

- + In addition to the instructions and recommendations for maintenance and care given here, additional service and/or repair work may be necessary; this must only be carried out by authorised service technicians.

5.2 Faults and Fault Diagnosis

The equipment undergoes regular quality controls during production. Nevertheless, faults or malfunctions may occur. Frequently, individual parts are responsible for these disturbances, an exchange is usually sufficient. Please refer to the following overview for the most common errors and how to correct them. If the equipment still does not function properly, contact your contract partner.

Fault	Cause	Solution
Cracking in the pedal area	Pedals loose	Tighten the pedals
Equipment wobbles	Equipment is not level	Align the feet
Handlebar/saddle wobbles	Loose screws	Tighten screws firmly
Display is blank/is not working	Batteries empty or loose cable connection	Replace batteries or check cable connections

No pulse display	<ul style="list-style-type: none"> + Sources of interference in the room + unsuitable chest strap + Wrong position of chest strap + Chest strap defective or battery empty + Pulse display defective 	<ul style="list-style-type: none"> + Eliminate sources of interference (e.g. mobile phone, WLAN, lawn mower and vacuum cleaner robot, etc. ...) + Use a suitable chest strap (see RECOMMENDED ACCESSORIES). + Reposition chest strap and/or moisten electrodes + Changing batteries + Check if pulse display by hand pulse possible
------------------	---	--

5.3 Error Codes and Troubleshooting

The electronics of the equipment continuously carries out tests. In case of deviations, an error code appears on the display and normal operation is stopped for your safety.

Please contact the contract partner for technical support.

5.4 Maintenance and Inspection Calendar

To avoid damage from body sweat, the equipment must be cleaned with a damp towel (no solvents!) after each training session.

The following routine tasks must be performed at the specified intervals:

Part	Weekly	Monthly
Display console	C	I
Plastic covers	C	I
Screws and cable connections		I
Check pedals for tightness		I
Legend: C = clean; I = inspect		

6 DISPOSAL

At the end of its operational life, this equipment cannot be disposed of in normal household waste. Instead, it must be disposed of via an electricals recycling centre. Further information can be obtained from your local authority's recycling service.



The materials can be recycled as per their symbols. Through the reuse, recycling of materials or other forms of recovery of old equipment, you make an important contribution to the protection of the environment.

7 RECOMMENDED ACCESSORIES

To make your training experience even more efficient and pleasant, we recommend that you add suiting accessories to your fitness equipment. For indoor cycles this could for example be a **floor mat**, which makes your fitness equipment stand more securely and also protects the floor from sweat or **silicone spray** to keep moving parts in good shape. For many indoor bikes it is possible to replace the **saddle** or **pedals**, as these are usually the same mounts used on bicycles.

If you have purchased a fitness machine with pulse training and want to train your heart rate, we strongly recommend that you use a compatible **chest strap**, as this ensures optimum transmission of the heart rate.

Our range of accessories offers the highest quality and makes training even better. If you would like to find out more about compatible accessories, please go to the detail page of the product in our webshop (the easiest way is to enter the article number in the search field above) and go to the recommended accessories on this page. Of course, you can also contact our customer service: by telephone, e-mail, in one of our branches or via our social media channels. We will be happy to advise you!



chest strap



floor mat



lubricant

8.1 Serial Number and Model Name

In order to provide you with the best possible service, please have the model name, article number, serial number, exploded drawing and parts list ready. The corresponding contact options can be found in chapter 10 of this operating manual.

NOTICE

The serial number of your equipment is unique. It's located on a white sticker. The exact position of this sticker is shown in the following illustration.

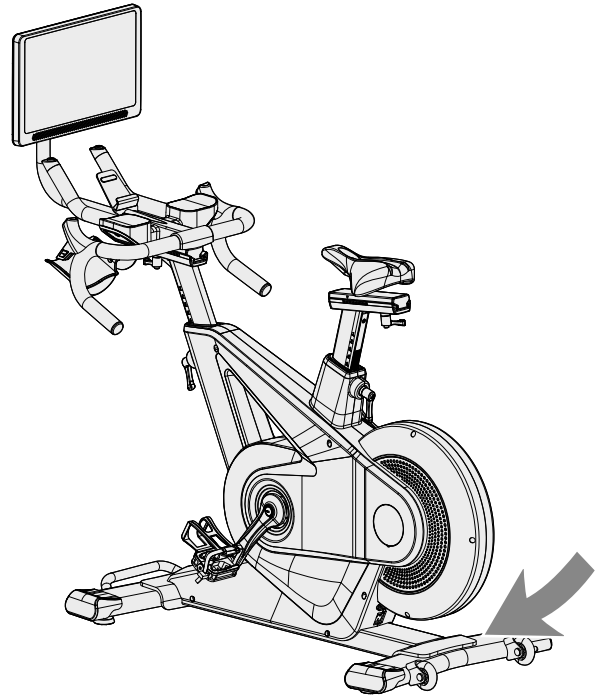

Enter the serial number in the appropriate field.

Serial number:

Brand / Category:

Model Name:

SKU:

8.2 Parts List

No.	Name	Supplier Parts No.	Specification	Qty.
1	Main frame	849S0-3-1000-J3		1
2	Rear stabilizer	849S0-3-2112-J1		1
3	Adjustable wheel	76100-6-2174-B0	D50*M10*1.5	4
4	Front stabilizer	849S0-3-2100-J1		1
5	Oval Cap	849S0-6-2190-B0	125.5*54.6*88.6L	4
6	Allen bolt M8*1.25*35L	50308-5-0035-F0	M8*1.25*35L,8.8level	6
7	ScrewM8x1.25x20L	25600-6-3191-F0	M8x1.25x20L,8.8level	8
8	Computer supporting tube	849S0-3-2460-J1		1
9	Spring washerD15.4xD8.2x2T	55108-2-1520-FA	D15.4xD8.2x2T	6
10L	Back chain cover(left)	849S0-6-4512-B0	D474*52.7	1
10R	Back chain cover(right)	849S0-6-4513-B0	D474*55.2	1
11	Round cycle for chain cover(1)	849S0-6-4510-B0	96*46*9.2	1
12	Round cycle for chain cover(2)	849S0-6-4511-B0	89*50.2*9.2	1
13	Seat post	849S0-3-2200-AF1	Laser marking	1
14	Inner insert	849S0-6-1071-B0	21.5*80*200L	2
15	Inner insert(2)	849S0-6-1093-B0	20*80*200L	2
16	Flat washerD16*D8.5*1.2T	55108-1-1612-FA	D16*D8.5*1.2T	6
17	Front post	849S0-3-2000-AF1	Two-side laser marking	1
18	L knob	52710-2-0020-RA	M10*20L	2
19	Cap(1)	849S0-6-2286-B0	55.7*29.4*18	4
20	Cap(2)	849S0-6-2287-B0	56.6*26.4*18	4
21	Bearing#6004-2RS	58006-6-1040-01	#6004-2RS(C0)	2
22	Waved washerD27*D20.3*0.5T	55120-5-2705-DA	D27*D20.3*0.5T	1
23	Handlebar adjustable tube	849S0-6-2018-AF2	56.3*30*210L	1
24	C-clip(D22.5*D18.5*1.2T)	55519-1-2312-DA	D22.5*D18.5*1.2T	2
25L	Chain cover supporting tube(left)	849S0-6-3111-J0	20*40*1.5T*50L	1
25R	Chain cover supporting tube(right)	849S0-6-3112-J0	38*38*1.5T*50L	1

26	Crank axle	849S0-6-2702-01	D20*128L	1
27	Pulley	58008-6-1041-00	D300*25.5*2.8T, 8 slots	1
28	Allen nutM10*1.5*8T	55210-2-2008-FA	M10*1.5*8T	5
29	Round head screw	54010-5-0020-F0	M10*1.5*20L	5
30	Belt	58004-6-1127-00	560 PJ8	1
31	Round magnet	174R4-6-2574-00	M02,Including base	1
32L	Qucik Upper cable(1)	849S0-6-2542-01	800L	1
32R	Qucik Upper cable(2)	849S0-6-2539-01	800L	1
33	Brake handlebar	849S0-6-2083-00	80.3*54*21.4	2
34	Cover of brake	849S0-6-2084-B0	96.8*69.6*33	2
35	Positioning block	849S0-6-2082-B0	35.5*24*14.2	2
36	Handlebar	849S0-3-2400-B2		1
37	ScrewST4*1.41*12L	52804-2-0012-F0	ST4*1.41*12L	8
38	ScrewST4.2*15L	52842-2-0015-F0	ST4.2*15L	20
39	ScrewST4*1.41*13L,D10	54704-2-0013-F0	ST4*1.41*13L,D10	1
40L	Computer bracket(left)	849S0-6-2568-B0	141.3*107.5*46.8	1
40R	Computer bracket(right)	849S0-6-2569-B0	141.3*107.5*38.8	1
41	Elbow pad sleeve	849S0-6-3488-B0	109*84*6T	2
42L	Left handbar protective cover	849S0-6-3780-B0	116*94.4*61	1
42R	Right handbar protective cover	849S0-6-3782-B0	116*94.4*61	1
43	Handbar protective cover	849S0-6-3784-B0	338.2*238.5*68.8	1
44	Flat washerD26*D21*1.5T	55120-1-2615-NA	D26*D21*1.5T	1
45	Side cap	19000-6-4582-e70	D99*11	2
46L	Left chain cover	849S0-6-4501-B0	898*80.1*675.4	1
46R	Right chain cover	849S0-6-4502-B0	898*77.8*675.4	1
47	ScrewST4.2*1.4*10L	53342-2-0010-F0	ST4.2*1.4*10L	14
48L	left crank	58007-6-1093-J1	170LxM20*1.5PLeft tooth, large square	1
48R	right crank	849S0-3-2704-J2		
49	Anti-loosen nutM10*1.25*9T	734S0-6-2775-N0	M10*1.25*9T,8.8level	2
50	screwcover	734S0-6-2779-B0	D29*11.5L	2
51L&51R	Pedal set(L&R)	58029-6-1161-B4	JD-004V M20*1.5P+Black SPD with beak and foot strap	1

52	screwM6*1.0P*16L	815S1-6-3191-F0	M6*1.0P*16L,8.8level	4
53L	Fixed plate(L)	849S0-6-2427-J0	154*75*4T	1
53R	Fixed plate(R)	849S0-6-2428-J0	154*75*4T	1
54L	Bottle holder(L)	850A1-6-2091-B1	148*119.8*83.5*5T	1
54R	Bottle holder®	850A1-6-2092-B1	148*119.8*83.5*5T	1
55	EMS system	849S0-3-3102-00	D270*D30*50,12kg	1
56	Pin	71600-6-4586-60	D6*26.5*7.7	14
57	Switching mode power supplier	261D8-6-2411-00	With a light source	1
58	Socket	26100-6-2413-00		1
59	ScrewST4*1.41*10L	51004-2-0010-F0	ST4*1.41*10L	2
60	Live wire	734S0-6-3480-00	150L	1
61	Neutral wire	734S0-6-3479-00	150L	1
62	Grounding cable	734S0-6-3486-00	200L	2
63	Upper computer cable	849S0-6-2572-00	700L	1
64	Middle computer cable	849S0-6-2587-01	500L, 250 Spool	1
65	Lower computer cable	849S0-6-2573-02	300L,	1
66	Power supply cord	26100-6-1775-02	1700L	1
67L	Button(-)	849S0-6-2534-RA1	31.7*21*10.5	1
67R	Button(+)	849S0-6-2533-RA1	31.7*21*10.5	1
68	Controller	747S0-6-2597-01	EMS-7600	1
69	Saddle	58001-6-1424-B0	VL-4290,	1
69A	Saddle lock	849S0-6-1074-F0	D22.2*M8(Opposite side 13 nut)	1
70	System external wire	821G0-6-3177-01	100L	1
71L	Button protective cover(L)	849S0-6-3672-B0	69.2*58*11.7, with hole	1
71R	Button protective cover(R)	849S0-6-3673-B0	69.2*58*11.2	1
72	Seat adjustable tube	849S0-3-4000-A40		1
73	Sensor cable	805S0-6-2576-00	500L	1
74	Power transmission line	849S0-6-2552-00	300L	1
75L	Trigger protective cover(L)	849S0-6-3674-B0	69.2*58*11.2	1
75R	Trigger protective cover(R)	849S0-6-3675-B0	69.2*58*11.7,with hole	1
76	ComputerSV8509-84	849S0-6-2501-B1	SV8509-84, 15.6",TFT	1
77	C-clipS-17(1T)	55517-1-0010-00	S-17(1T)	1

78	Waved washerD17*D22*0.3T	55117-5-2203-DA	D17*D22*0.3T	3
79	Bearing6203-2RS	58006-6-1026-01	6203-2RS Plastic cover	2
80	Plastic flat washer	55110-1-2404-BF	D10*D24*0.4T	3
81	Allen boltM8*1.25*30L	50308-5-0030-C0	M8*1.25*30L,8.8level	1
82	Flat washerD28*D8.5*3T	55108-1-2830-NA	D28*D8.5*3T	1
83	Handlebar plug	849S0-6-2475-F0	D35*15L	2
84	Spring	58003-6-1024-N0	D2.2*D14*65L	1
85	Fixing plate for idle wheel	744G0-3-1600-00		1
86	Plastic flat washer	55110-1-5010-BF	D50*D10*1.0T	1
87	Allen nutM8*1.25*8T	55208-2-2006-NA	M8*1.25*8T	1
88	Nylon nutM8*1.25*8T	55208-1-2008-NA	M8*1.25*8T	2
89	Handlebar grips(1)	849S0-6-2468-B1	D24*3.5T*270L	2
90	Handlebar grips(2)	849S0-6-2469-B1	D24*3.5T*530L	2
91	Protection Strip	815S5-6-2278-B0	50*10*3T	1
92L	Lower cable of quick key(1)	849S0-6-2544-01	650L	1
92R	Lower cable of quick key(2)	849S0-6-2536-01	650L	1
93L	Quick Keys Group 1	849S0-6-2540-B2	400L, Silver	1
93R	Quick Keys Group 2	849S0-6-2541-B2	400L, Silver	1
94	Bushing	58002-6-1099-00	D22.2*D8.2*7T	4
95	Fixed shaft	849S0-6-2371-N0	D8*31.5L*M4*0.7P	2
96	ScrewM4*0.7*12L	51404-2-0012-CU0	M4*0.7*12L	4
97	Flat washerD16*D5*1.0T	55105-1-1610-FA	D16*D5*1.0T	4
98	Screw trim cover group	849S0-3-2350-00	D19.5*D5*5T	4
99	Cushion	55306-4-0013-B9	D9*D5.8*13	5
100	Block	849S0-6-4073-00	23.5*10.6*25L	2
101	Round wheel	84302-6-2175-RA0	D70.5*23,pantone1795C	2
102	BoltM5*0.8*10L	52605-5-0010-F0	M5*0.8*10L,8.8level	6
103	ScrewM6*1.0*10L	54006-5-0010-F0	M6*1.0*10L,8.8level	6
104	Flat washerD25*D10*2.0T	55110-1-2520-FA	D25*D10*2.0T	2
105	BoltM5*0.8*12L	52605-2-0012-F0	M5*0.8*12L	2
106	Seat tube limit piece	849S0-6-2273-F0	486*19*2T	2
107	Countersunk small taper screws	51405-2-0010-F0	M5*0.8*10L	4
108	ScrewM5*0.8*10L	54805-2-0010-N0	M5*0.8*10L,Full Teeth	2

109	ScrewM6*1.0*20L	54006-5-0020-F0	M6*1.0*20L,8.8level	1
110	ScrewM6*1*12L	54806-2-0012-N0	M6*1*12L	6
111	Flat washerD13*D6.5*1.0T	55106-1-1310-NA	D13*D6.5*1.0T	2
112	ScrewM5*0.8*20L	54805-2-0020-N0	M5*0.8*20L,Full Teeth	1
113	Allen nutM5*0.8*5T	55205-2-2005-NA	M5*0.8*5T	1
114	Spring	58003-6-1081-N0	D1.2*D19.6*15.3L	2
115	Anchor Post	849S0-6-1172-F1	19.7*19.7*14.5L	2
116	Nut Cap	849S0-6-1171-F0	D30*12L*M24*2.0p	2
117	L knob	849S0-6-1072-RA0	M12*25L	2
118	Handle	849S0-6-5103-J2	D25.4*1.4T*373L	1
119	Cushion	849S0-6-1081-B0	194.3*107*1.2T	2
120	ScrewST2.3*8L	54723-2-0008-C0	ST2.3*8L	4
121	ScrewST2.3*12L	51023-2-0012-F0	ST2.3*12L	2
122	ScrewST2.9*13L	51029-2-0013-CU0	ST2.9*13L	4
123	Computer fixing plate	849S0-6-2402-J0	97*96*3T	1
124	Universal u-seat	849S0-6-3751-J0	78.5*41.5*4T	1
125	BoltM10*1.5*60L	50110-2-0060-F4	M10*1.5*60L	1
126	Flat washerD20*D11*2T	55110-1-2020-FA	D20*D11*2T	2
127	Sleeve(2)	387C2-6-1616-N0	D17*D10.5*26L	1
128	ScrewM10*1.5*8T	55210-2-2008-FA	M10*1.5*8T	1
129	BoltM8*1.25*60L	50308-5-0060-F3	M8*1.25*60L	1
130	Bushing	58002-6-1026-N0	D8.2xD12.7x33	1
131	Flat washerD18*D8.5*1.0T	55108-1-1810-W8	D18*D8.5*1.0T	2
132	BoltM5*0.8*10L	52605-5-0010-F0	M5*0.8*10L	2
133	Tablet pad	849S0-6-2466-B0	70*22.8*21	1
134	ScrewST2.9x9.5L	53329-2-0009-F0	ST2.9x9.5L	2
135	Knurled hand screw	849S0-6-3493-00	M5*12	4
136	Magnetic rings	26100-6-1079-00	D31*16	2
137	External teeth lock gasket	55105-6-1006-FA	D10*D5.3*0.6T	2
138	ScrewM5*0.8*35L	50805-2-0035-N0	M5*0.8*35L	1
	Allen cross wrentch	58030-6-1031-N1	M6,8.8	1
	Open-end wrentch	58030-6-1050-C0	153*6.5T	1

8.3 Exploded Drawing

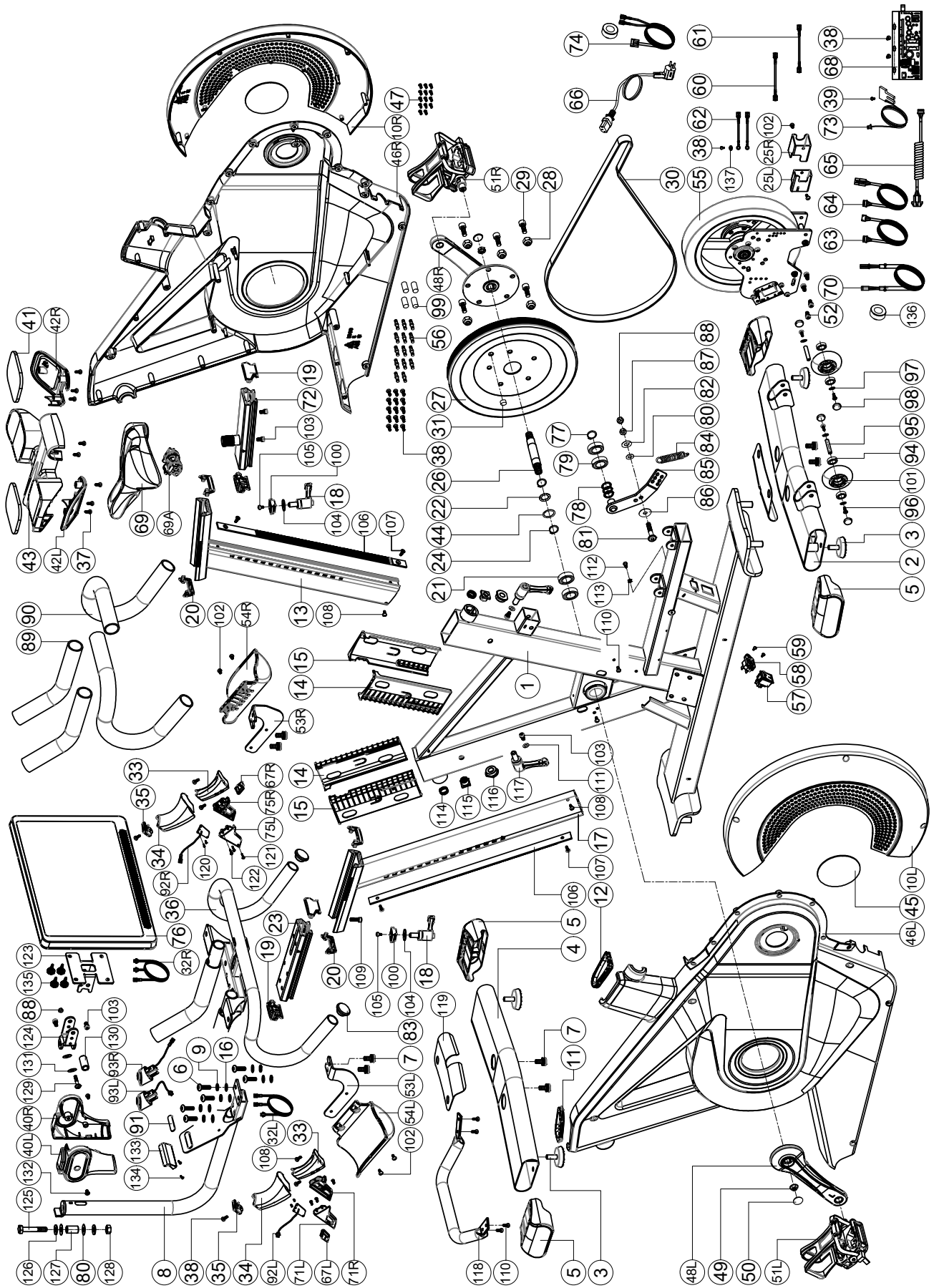

Products from TAURUS® are subject to strict quality control. However, if a fitness equipment purchased from us does not work perfectly, we take it very seriously and ask you to contact our customer service as indicated. We are happy to help you by phone via our service hotline.

Error Descriptions

Your fitness equipment is developed for long-term, high-quality training. However, should a problem arise, please first read the operating instructions. For further assistance, please contact your contract partner or call our service hotline. To ensure your problem is solved as quickly as possible, please describe the defect as exactly as possible.

In addition to the statutory warranty, we provide a warranty for every fitness equipment purchased from us according to the following provisions.

Your statutory rights are not affected.

Warrantee

The warrantee is the first/original buyer.

Warranty periods

The following warranty periods begin on delivery of the fitness equipment.

Warranty period

The warranty periods, shown on our web shop, begin on delivery of the fitness equipment. The respective warranty periods for your equipment can be found on its product website.

Repair Costs

According to our choice, there will either be a repair, a replacement of individual damaged parts or a complete replacement. Spare parts, that have to be mounted while assembling the equipment, have to be replaced by the warrantee personally and are not a part of repair. After the expiration of the warranty period, the responsibility for parts costs, repair costs, installation costs and delivery costs lies with the warranty holder.

The terms of use are defined as follows:

- + Home use: solely for private use in private households up to 3 hours per day
- + Semi-professional use: up to 6 hours per day (e. g. rehabilitation centres, hotels, clubs, company gyms)
- + Professional use: more than 6 hours per day (e. g. commercial gyms)

Warranty Service

Within the warranty period, equipment which develops faults as a result of material or manufacturing defects, will be repaired or replaced at our discretion. Ownership of equipment or parts of equipment which have been replaced is transferred to us. The warranty period is not extended nor does a new warranty period begin following repair or replacement under the warranty.

Warranty Conditions

For the warranty to be valid, the following steps must be taken:

Please contact our customer service by email or phone. If the product under warranty has to be sent in for repair, the seller bears costs. After expiry of the warranty, the buyer bears the costs of transport and insurance. If the fault is covered by our warranty, you will receive a new or repaired equipment in return.

Warranty claims are invalid in case of damage resulting from:

- + misuse or improper handling
- + environmental influences (moisture, heat, electrical surge, dust, etc.)
- + failure to follow the current safety measures for the equipment
- + failure to follow the operating instructions
- + use of force (e. g. hitting, kicking, falling)
- + interventions which were not carried out by one of our authorized service centres
- + unauthorised repair attempts

Proof of Purchase and Serial Number

Please make sure that you are able to provide the appropriate receipt when claiming on your warranty. So that we can clearly identify the model of your equipment, and for the purposes of our quality control, you will need to give the serial number of your equipment, when contacting the service team. Where possible please have your serial number and your customer number ready when you call our service hotline. It will help us to deal with your request swiftly.

If you cannot find the serial number on your fitness equipment, our service team is at your disposal to offer further information.





































Service outside of the Warranty Period

We are also happy to issue an individual cost estimate if there is a problem with your fitness equipment after the warranty has expired, or in cases which do not fall under the terms of the warranty, e. g. normal wear and tear. Please contact our customer service team to find a quick and cost-effective solution to your problem. In such a case you will be responsible for the delivery costs.

Communication

Many problems can be solved just by speaking to us as your specialist supplier. We know how important it is to you as a user of the fitness equipment to have problems solved quickly and simply, so you can enjoy working out with minimal interruption. For that reason, we also want to resolve your queries quickly and in a straightforward manner. Thus, please always keep your customer number and the serial number of the faulty equipment handy.

10 CONTACT

DE	DK	UK
<p>TECHNIK</p> <p> +49 4621 4210-900</p> <p> +49 4621 4210-698</p> <p> technik@fitshop.de</p> <p> Öffnungszeiten entnehmen Sie unserer Homepage.</p>	<p>TEKNIK OG SERVICE</p> <p> 80 90 16 50</p> <p>+49 4621 4210-945</p> <p> info@fitshop.dk</p> <p> Åbningstider kan findes på hjemmesiden: https://stg.fit/statit7</p>	<p>CUSTOMER CARE</p> <p> +44 141 737 2249 or +44 141 876 3972</p> <p> customercare@fitshop.co.uk</p> <p> You can find the opening hours on our homepage: https://stg.fit/statitd</p>
<p>SERVICE</p> <p> 0800 20 20277 (kostenlos)</p> <p> 04621 4210 - 0</p> <p> info@fitshop.de</p> <p> Öffnungszeiten entnehmen Sie unserer Homepage: https://stg.fit/statita</p>	<p>FR</p> <p>TECHNIQUE & SERVICE</p> <p> +33 (0) 189 530984</p> <p>+49 4621 42 10 933</p> <p> info@fitshop.fr</p> <p> Vous trouverez les heures d'ouverture sur notre site Internet: https://stg.fit/statit4</p>	<p>BE</p> <p>TECHNIQUE & SERVICE</p> <p> 02 732 46 77</p> <p>+49 4621 4210 933</p> <p> info@fitshop.be</p> <p> Vous trouverez les heures d'ouverture sur notre site Internet: https://stg.fit/statit8</p>
<p>ES</p> <p>TECNOLOGÍA Y SERVICIOS</p> <p> 911 238 029</p> <p> info@fitshop.es</p> <p> Consulta nuestro horario de apertura en la página web: https://stg.fit/statit5</p>	<p>NL</p> <p>TECHNISCHE DIENST & SERVICE</p> <p> +31 172 619961</p> <p> service@fitshop.nl</p> <p> De openingstijden vindt u op onze homepage: https://stg.fit/statit3</p>	<p>INT</p> <p>TECHNICAL SUPPORT & SERVICE</p> <p> +49 4621 4210-944</p> <p> service-int@fitshop.de</p> <p> You can find the opening hours on our homepage: https://stg.fit/statita</p>
<p>PL</p> <p>DZIAŁ TECHNICZNY I SERWIS</p> <p> 22 307 43 21</p> <p>+49 4621 42 10-948</p> <p> info@fitshop.pl</p> <p> Godziny otwarcia można znaleźć na stronie głównej: https://stg.fit/statit6</p>	<p>AT</p> <p>TECHNIK & SERVICE</p> <p> 0800 20 20277 (Freecall)</p> <p>+49 4621 42 10-0</p> <p> info@fitshop.at</p> <p> Öffnungszeiten entnehmen Sie unserer Homepage: https://stg.fit/statitb</p>	<p>CH</p> <p>TECHNIK & SERVICE</p> <p> 0800 202 027</p> <p>+49 4621 42 10-0</p> <p> info@fitshop.ch</p> <p> Öffnungszeiten entnehmen Sie unserer Homepage: https://stg.fit/statit9</p>

Please find a detailed overview including address and opening hours for all stores of Fitshop UK on the following website:

www.fitshop.co.uk/storelocator

WE LIVE FITNESS

WEBSHOP AND SOCIAL MEDIA

The Fitshop Group is Europe's largest specialist for home fitness equipment with currently 70 stores and one of the world's most renowned online mail order companies for fitness equipment.

Fitshop UK is part of the Fitshop Group. Private customers order via the 25 web shops in the respective national language or have their desired equipment assembled on site. In addition, the company supplies fitness studios, hotels, sports clubs, companies and physio practices with professional equipment for endurance and strength training.

The Fitshop group offers a wide range of fitness equipment from renowned manufacturers, high-quality in-house developments and comprehensive services, such as a build-up service and sports scientific advice before and after the purchase. The company employs numerous sports scientists, fitness trainers and competitive athletes.

Visit us also on our social media platforms or our blog!



<https://www.fitshop.co.uk/>
www.fitshop.co.uk/blog/



www.facebook.com/fitshop.co.uk



www.instagram.com/fitshop_uk



www.youtube.com/@fitshop_uk

TAURUS

 cardiostrong 

BODYCRAFT

BodyMax

Notes

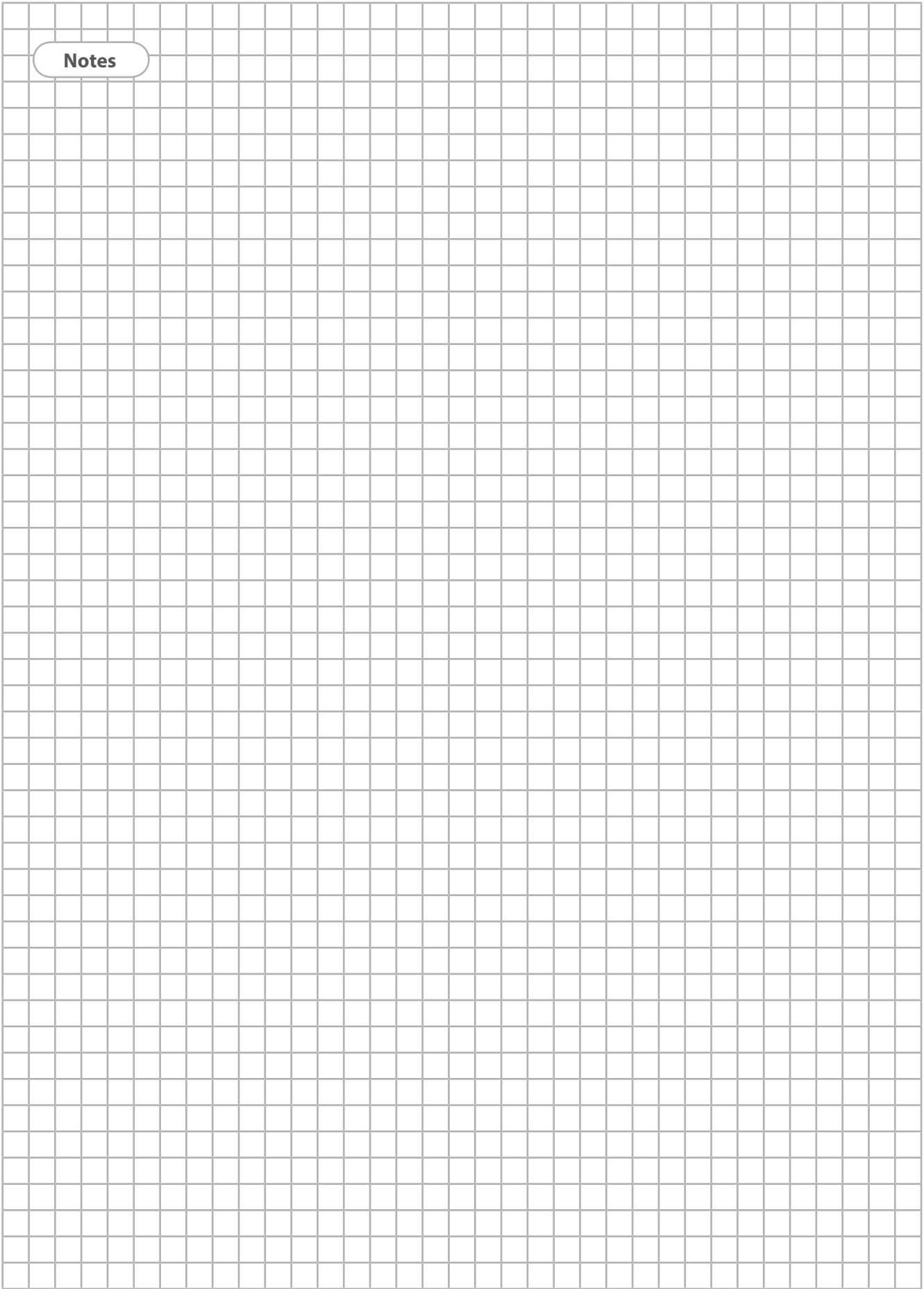

Notes

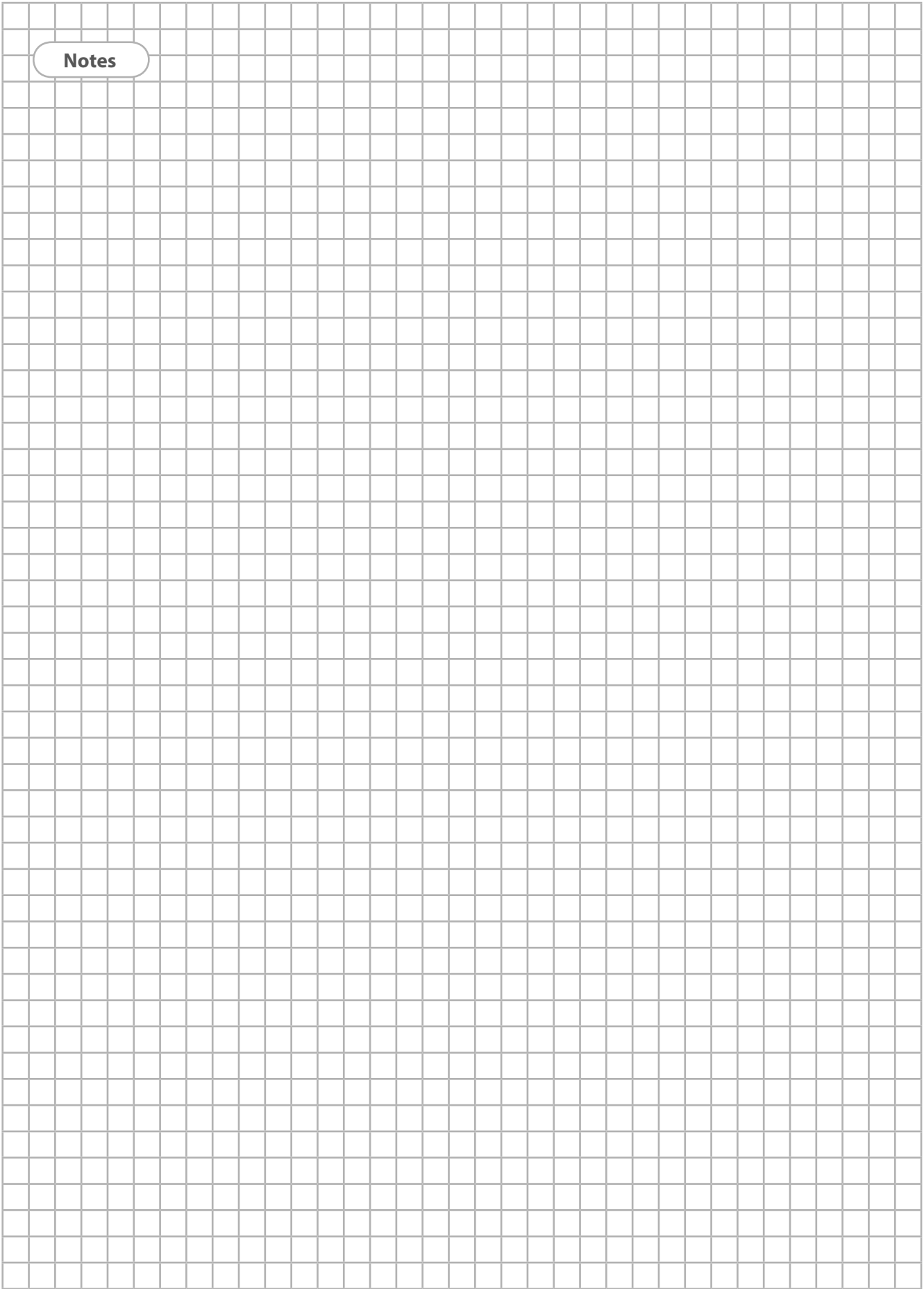

TAURUS®

Taurus Racer Pro Touch