

# TAURUS®

## Assembly and Operating Instructions

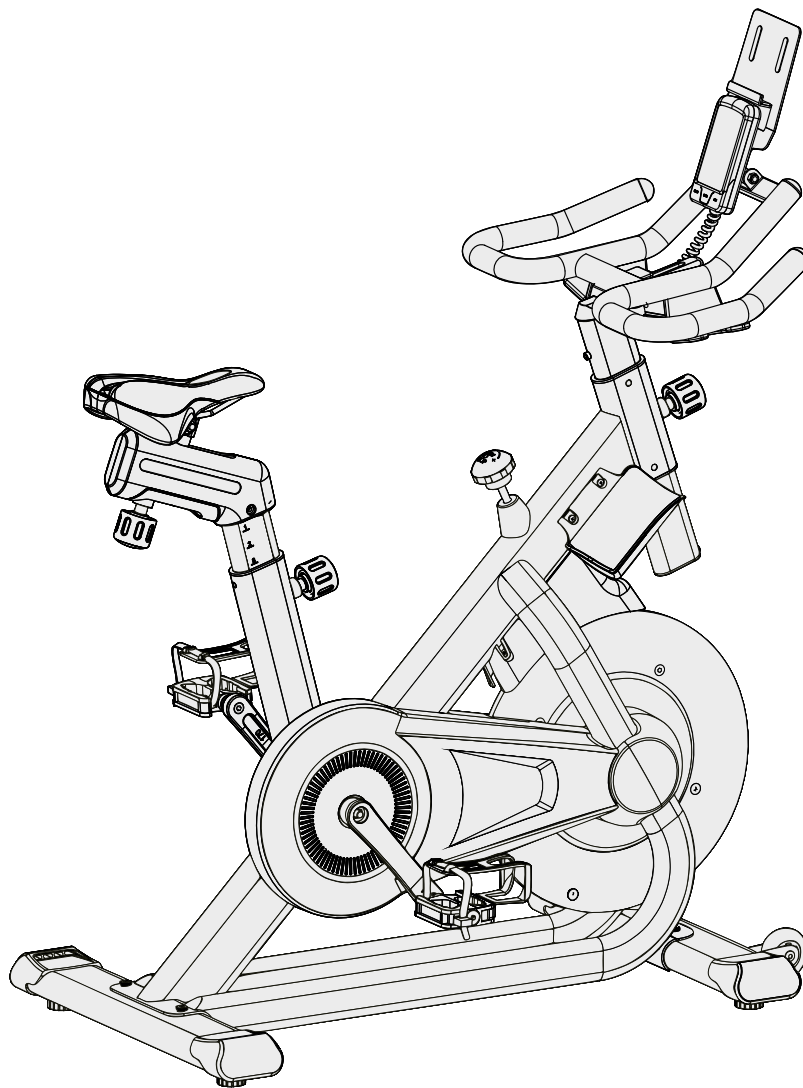

max. 150 kg



~ 60 Min. 



 47 kg

L 114 | W 58 | H 145

FSUKTFIC70PROS.01.05

SKU:IC70PRO-S

**Taurus IC70 Smart**



# Content

<b>1</b>	<b>GENERAL INFORMATION</b>	<b>8</b>
1.1	Technical Data	8
1.2	Personal Safety	10
1.3	Electrical Safety	11
1.4	Set-Up Place	12
<b>2</b>	<b>ASSEMBLY</b>	<b>13</b>
2.1	General Instructions	13
2.2	Scope of Delivery	14
2.3	Assembly	16
2.4	Battery Replacement	22
<b>3</b>	<b>OPERATING INSTRUCTIONS</b>	<b>23</b>
3.1	Console Display	23
3.2	Button Functions	25
3.3	Emergency Brake	25
3.4	Turning on and Setting Up the Equipment	26
3.5	Energy Saving Mode	26
3.6	Training Instructions	27
3.6.1	Quick Start Function	27
3.6.2	Setting Target Values	28
3.7	Compatibility Training Apps	30
3.7.1	Connection with Kinomap	30
3.8	Wireless Technology and Fitness Apps	32
<b>4</b>	<b>STORAGE AND TRANSPORT</b>	<b>33</b>
4.1	General Instructions	33
4.2	Transportation Wheels	33
<b>5</b>	<b>TROUBLESHOOTING, CARE AND MAINTENANCE</b>	<b>34</b>
5.1	General Instructions	34
5.2	Faults and Fault Diagnosis	34
5.3	Error Codes and Troubleshooting	35
5.4	Maintenance and Inspection Calendar	35
<b>6</b>	<b>DISPOSAL</b>	<b>35</b>
<b>7</b>	<b>RECOMMENDED ACCESSORIES</b>	<b>36</b>

<b>8</b>	<b>ORDERING SPARE PARTS</b>	<b>37</b>
8.1	Serial Number and Model Name	37
8.2	Parts List	38
8.3	Exploded Drawing	42
<b>9</b>	<b>WARRANTY</b>	<b>43</b>
<b>10</b>	<b>CONTACT</b>	<b>45</b>

**Dear customer,**

Thank you for choosing a high-quality equipment of the brand TAURUS®. Taurus offers sports and fitness equipment for the sophisticated home sport and the equipment of fitness studios and business customers. With Taurus fitness equipment, the focus is on what sport is all about: maximum performance! Therefore, the equipment is developed in close consultation with athletes and sports scientists. Because athletes know best what makes perfect fitness equipment.

Further information can be found at [www.fitshop.co.uk](http://www.fitshop.co.uk)

**Intended Use**

The equipment may only be used for its intended purpose.

The equipment is suitable for home use and semi-professional use (e.g. hospitals, clubs, hotels, schools, etc.). The equipment is not suitable for commercial or professional use (e.g. fitness studio).

**Legal Notice**

Fitshop GmbH  
Europe's No. 1 for home fitness

International Headquarters  
Flensburger Straße 55  
24837 Schleswig  
Germany

Management:  
Christian Grau  
Sebastian Campmann  
Dr. Bernhard Schenkel  
No. HRB 1000 SL  
Local Court Flensburg  
European VAT Number: DE813211547

**Disclaimer**

© TAURUS is a registered brand of the company Fitshop GmbH. All rights reserved. Any use of this trademark without the explicit written permission of Fitshop is prohibited.

Product and manual are subject to change. Technical data can be changed without advance notice.

**FITSHOP**

Europe's No.1 for Home Fitness

## ABOUT THIS MANUAL

Please carefully read the entire manual before installation and first use. The manual will help you to quickly set up the system and explains how to safely use it. Make sure that all persons exercising with the equipment (especially children and persons with physical, sensory, mental or motor disabilities) are informed about this manual and its contents in advance. In case of doubt, responsible persons must supervise the use of the equipment.

Due to ongoing changes and software optimisations, the manual may have to be updated. If you notice any discrepancies during assembly or use, please refer to the manual uploaded to the webshop. The latest manual is always available there.



This equipment has been manufactured according to the latest safety knowledge. As far as possible, potential safety hazards which could cause injury have been eliminated. Make sure to carefully follow the instructions and that all parts are securely in place. If required, read through the instructions again to correct any mistakes.

Training devices must be classified according to accuracy and use. Accuracy classes are only applicable to devices that display training data.

### Accuracy classes

Class A: high accuracy.

Class B: medium accuracy.

Class C: low accuracy.

The use classes explain the intended use of the training device.

### Use classes

**Class S** (studio): professional and/or commercial use.

These training devices are intended for the use in training rooms of facilities such as sports clubs, school facilities, hotels, clubs and studios whose access and supervision is specifically regulated by the owner (person with legal responsibility).

**Class H** (home use): use at home.

These stationary training devices are intended for the use in private homes where access to the training device is regulated by the owner (person with legal responsibility).

Please pay close attention to the safety and maintenance instructions given here. The contract partner cannot be held liable for damage to health, accidents or damage to the equipment when it is not used in accordance with these instructions.

The following safety instructions may appear in this manual:

► **ATTENTION**

This notice indicates potentially hazardous situations which, if not avoided, may result in property damage.

⚠ **CAUTION**

This notice indicates potentially hazardous situations which, if not avoided, may result in slight or minor injuries!

⚠ **WARNING**

This notice indicates potentially hazardous situations which, if not avoided, may result in death or serious injuries!

⚠ **DANGER**

This notice indicates potentially hazardous situations which, if not avoided, will result in death or serious injuries!

ⓘ **NOTICE**

This notice indicates further useful information.

Retain these instructions in a safe place for future reference, maintenance or when ordering replacement parts.

## 1.1 Technical Data

### LCD Display:

- + Training time
- + Speed
- + Revolutions per minute (RPM)
- + Distance
- + Calories burned
- + Pulse (when using a compatible chest strap)
- + Watt
- + Resistance level

Resistance system:	manual magnetic brake system
Resistance levels:	99
Flywheel mass:	14 kg

Wattage	
Min. and max. watts at 60 RPM:	19 - 450 W
Min. and max. watts at 100 RPM:	38 - 1029 W

Battery type:	Alkaline battery 1.5V AA
---------------	--------------------------

### Weight and Dimensions

Packaging dimensions (L x W x H) approx.:	110 cm x 24.5 cm x 93 cm
Set-up dimensions (L x W x H) approx.:	114 cm x 58 cm x 145 cm

Article weight (gross, incl. packaging) approx.:	52.5 kg
Article weight (net, excl. packaging) approx.:	47.2 kg

Maximum user weight:	150 kg
----------------------	--------

Q-factor:	16.5 cm
-----------	---------

Use class:	S
------------	---



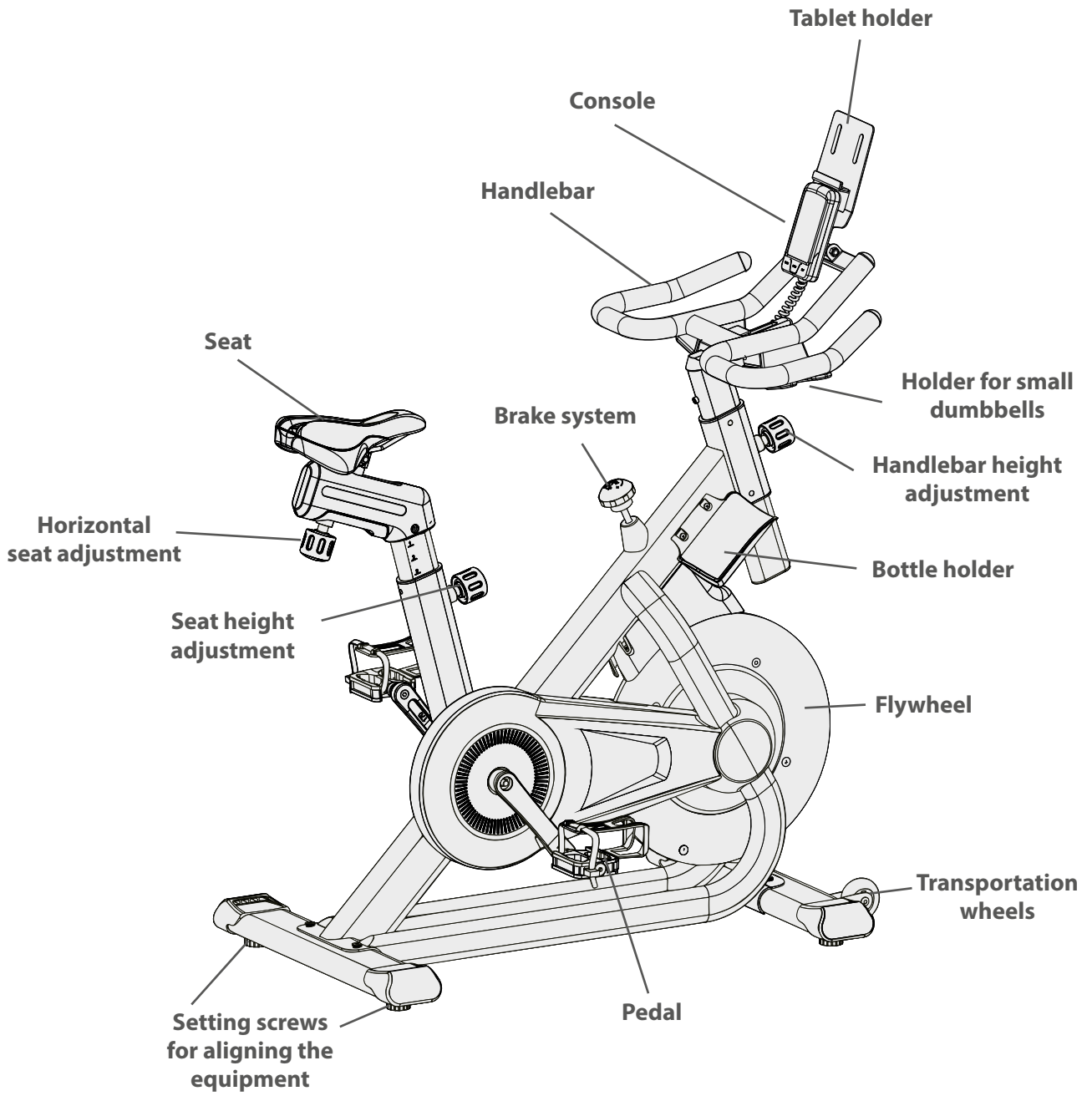

## 1.2 Personal Safety

### **DANGER**

- + Before you start using the equipment, you should consult your physician that this type of exercise is suitable for you from a health perspective. Particularly affected are persons who: have a hereditary disposition to high blood pressure or heart disease, are over the age of 45, smoke, have high cholesterol values, are overweight and/or have not exercised regularly in the past year. If you are under medical treatment that affects your heart rate, medical advice is absolutely essential.
- + Note that excessive training can seriously endanger your health. Please also note that heart rate monitoring systems can be inaccurate. If you notice any signs of weakness, nausea, dizziness, pain, shortness of breath, or other abnormal symptoms, stop exercising immediately and seek advice from your doctor if necessary.
- + The owner must communicate all warnings and instructions to the user.

### **WARNING**

- + This equipment may not be used by children under the age of 14.
- + Children should not be allowed unsupervised access to the equipment.
- + Persons with disabilities must have a medical license and must be under strict observation when using the equipment.
- + The equipment is strictly for use by one person at a time.
- + If your equipment provides a safety key, the clip of the safety key must be attached to your clothing before starting your training. In the event of a fall, the EMERGENCY STOP of the equipment can be initiated.
- + There is a risk of injury from spinning pedals and/or an exposed flywheel in the absence of a freewheel. Never get on or off the equipment when the pedals or the flywheel are still moving. Always make sure that the pedals and the flywheel have come to a complete stop.
- + Support yourself with at least one hand on the handlebar when getting on and off the equipment. Only dismount from the equipment when the pedals have come to a complete stop.
- + Keep your hands, feet and other body parts, hair, clothing, jewellery and other objects well clear of moving parts.
- + During use, wear suitable sports clothing rather than loose or baggy clothing. When wearing sports shoes, make sure they have suitable soles, preferably made of rubber or other non-slip materials. Shoes with heels, leather soles, studs or spikes are unsuitable. Never exercise barefoot.

### **CAUTION**

- + If your equipment needs to be connected to the power supply with a mains cable, make sure that the cable is not a potential tripping hazard.
- + Make sure that nobody is within the range of motion of the equipment during training so as not to endanger you or other persons.
- + Always tighten the pedal strap before you start training to prevent your feet from slipping.



### **CAUTION**

- + Be aware that if adjustment devices are left protruding, they may impede the user's movement.

### **▶ ATTENTION**

- + Do not insert any objects of any kind into the openings of the device.
- + To protect the equipment from use by unauthorised third parties, always remove the power cable when not in use and store it in a safe place that is inaccessible to unauthorised persons (e.g. children).
- + Class B and C crank training equipment is not suitable for high accuracy purposes.

## **1.3 Electrical Safety**



### **DANGER**

- + In order to reduce the risk of an electric shock, always unplug the equipment from the mains socket immediately after your workout, before assembly or dismantling, and before maintenance or cleaning. Do not pull on the cable.



### **WARNING**

- + Do not leave the equipment unattended while the mains cable is plugged into the mains socket. During your absence, the mains cable must be removed from the mains socket to prevent improper use by third parties or children.
- + If the mains cable or plug is damaged or defective, contact your contract partner. Until repair, the equipment must not be used.

### **▶ ATTENTION**

- + The equipment requires a mains connection of 220-230 V with 50 Hz mains voltage.
- + The equipment may only be connected directly to an earthed socket using the supplied mains cable. Extension cables must conform to VDE guidelines. Always completely unwind the mains cable.
- + The socket must be protected by a fuse with a minimum fuse rating of "16 A, slow blow".
- + Do not make any changes to the mains cable or the mains plug.
- + Keep the mains cable away from water, heat, oil and sharp edges. Do not route the mains cable underneath the equipment or under a carpet or rug, and do not place any objects on top of it.
- + If your purchased item is equipped with a TFT console, software updates must be carried out regularly. Follow the instructions on the console to perform the update(s).
- + The software systems on gym equipment with TFT consoles are set up only for the pre-installed apps. Do not install any additional apps.



### **NOTICE**

- + The pre-installed apps on TFT consoles are produced and provided by external manufacturers. Fitshop does not take any responsibility for the availability, functionality or contents of these apps.
- + Hereby, Fitshop GmbH declares that the radio equipment type Wireless Connection (2.402 – 2.480 GHz) complies with Directive 2014/53/EU. The full text of the EU Declaration of Conformity is available at the following website: [www.fitshop.com](http://www.fitshop.com).

## 1.4 Set-Up Place

### **WARNING**

- + Do not place the equipment in main corridors or escape routes.

### **CAUTION**

- + Choose a location in which to place the equipment such that there is enough free space/clearance to the front, the rear and to the sides of the equipment.
- + The training room should be well ventilated during training and not be exposed to any draughts.
- + Choose the place in which to set up the equipment such that there is enough free space/clearance to the front, the rear and to the sides of the equipment.
- + The free area in the direction from which the exercise equipment is accessed must be at least 0.6 m larger than the exercise area.
- + The set-up and mounting surface of the equipment should be flat, loadable and solid.

### **ATTENTION**

- + The device may only be used in one building, in sufficiently tempered and dry rooms (ambient temperatures between 10°C and 35°C). The equipment should not be used outdoors or in rooms with high humidity (over 70%) like swimming pools.
- + A floor protective mat/equipment underlay can help to protect high-quality floor coverings (parquet, laminate, cork, carpets) from dents and sweat and can help to level out slight unevenness.
- + For Class S equipment, the exercise equipment may only be used in areas where access, supervision and control are specifically regulated by the owner.

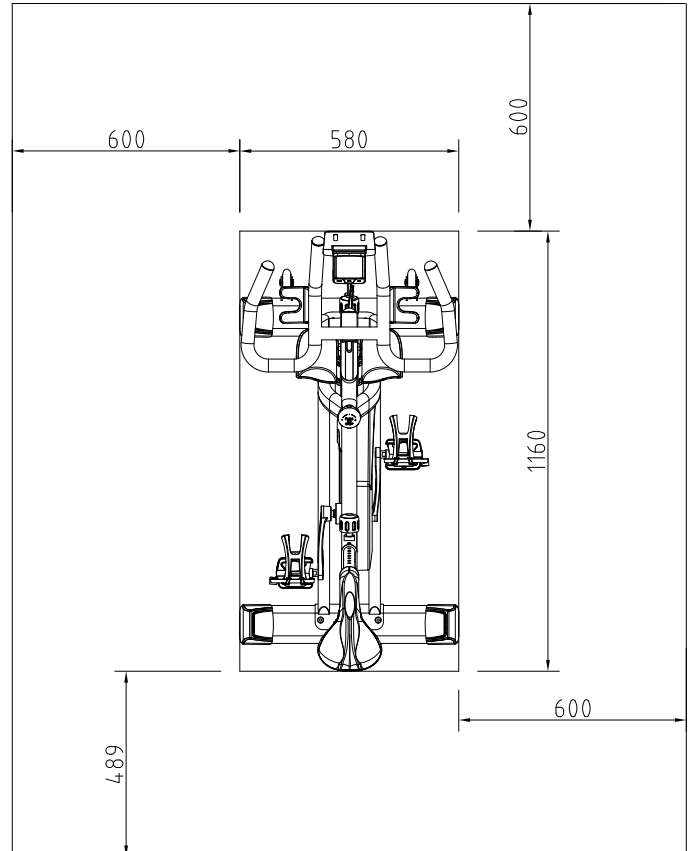

### 2.1 General Instructions



#### **DANGER**

- + Do not leave any tools, packaging materials such as foils or small parts lying around, as otherwise there is a danger of suffocation for children. Keep children away from the equipment during assembly.



#### **WARNING**

- + Pay attention to the instructions attached to the equipment in order to reduce the risk of injuries.



#### **CAUTION**

- + Ensure to have sufficient room for movement in each direction during assembly.
- + The assembly of the equipment must be carried out by at least two adults. If in doubt, seek the help of a third technically skilled person.



#### **ATTENTION**

- + To prevent damage to the equipment and the floor, assemble the equipment on a mat or packaging board.



#### **NOTICE**

- + In order to make the assembly as simple as possible, some screws and nuts to be used can already be pre-assembled.
- + Ideally, assemble the equipment at its later set-up place.

## 2.2 Scope of Delivery

The scope of delivery consist of the following parts. At the beginning, check whether all parts and tools belonging to the device are included in the scope of delivery and whether damage has occurred. In the event of complaints, the contractual partner must be contacted directly.



### CAUTION

If parts of the scope of delivery are missing or damaged, the assembly must not be carried out.



### NOTICE

Batteries are not included in the scope of delivery. The following batteries are required: 2x AA

Part no.	Description	Quantity
1	Main Frame	1
2	Front Stabilizer	1
3	Rear Stabilizer	1
4	Seat Post	1
6	Handlebar	1
9	Computer Fixing Plate	1
10	Computer	1
12L	Left Seat Protective Cover	1
12R	Right Seat Protective Cover	1
23L	Left Pedal	1
23R	Right Pedal	1
60	Seat	1
82L	Left Bottle Holder	1
82R	Right Bottle Holder	1
	Hardware Pack	1

1

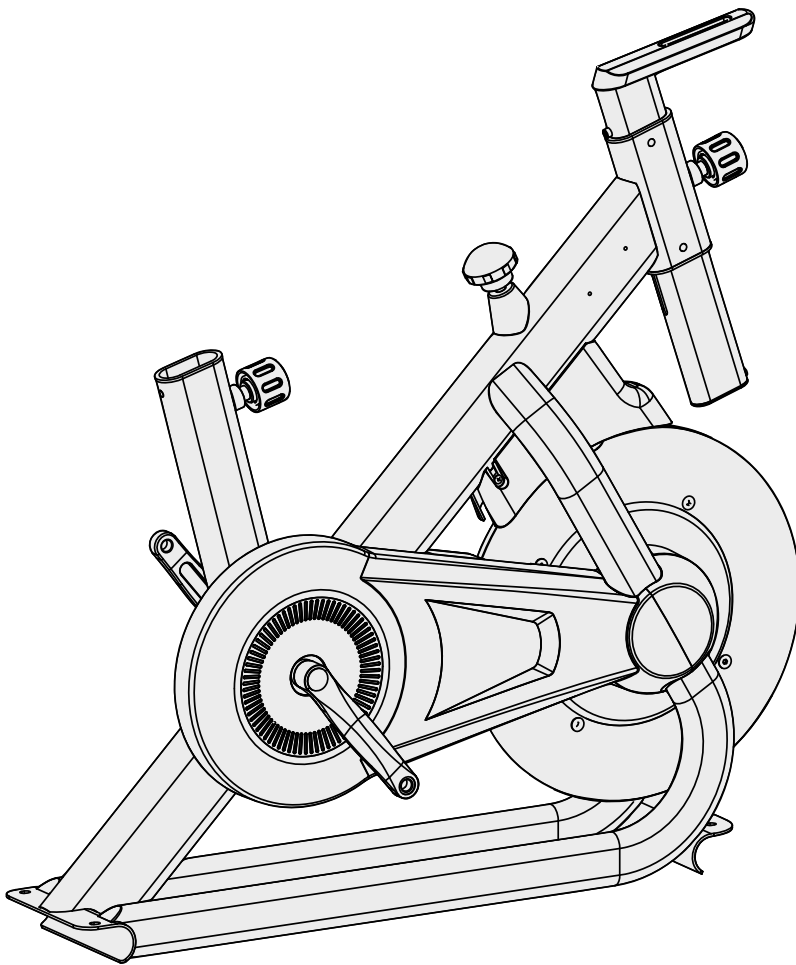

X1

4

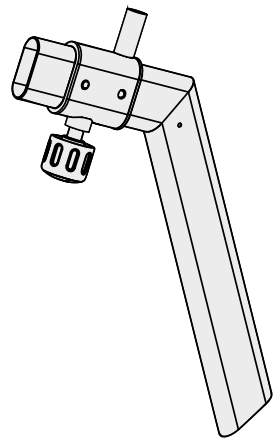

X1

6

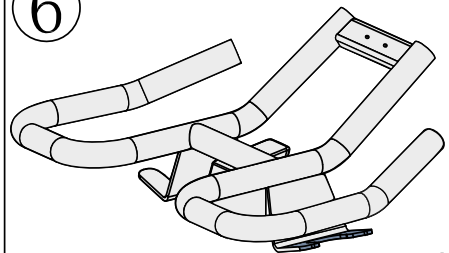

X1

2

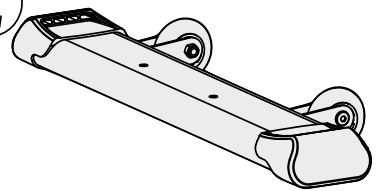

X1

60

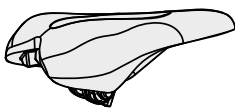

X1

9

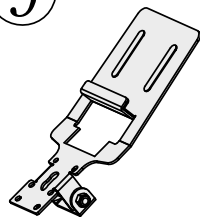

X1

23L & 23R

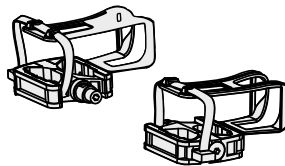

X1

12L & 12R

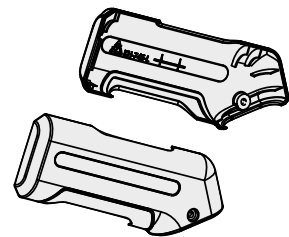

X1

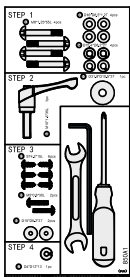

X1

10

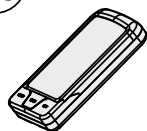

X1

82L & 82R

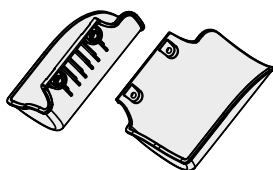

X1

3

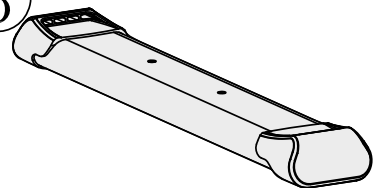

X1

## 2.3 Assembly

Before assembly, take a close look at the individual assembly steps shown and carry out the assembly in the order given.

### **NOTICE**

- + First loosely screw all parts together and check that they fit properly. Tighten the screws using the tool only when you are instructed to do so.
- + If you have difficulty recognising the graphics, we recommend that you open and/or download the PDF instructions stored in the webshop on your end device (e.g. smartphone, tablet or PC). There you have the option of zooming in closer.

### Step 1: Assembly of the Main Frame and the Stabilizers

### **NOTICE**

It can make the assembly easier if you place some styrofoam underneath the main frame when performing the assembly step.

1. Attach the front stabilizer (2) to the main frame (1) with two bolts (32), two spring washers (34) and two flat washers (33).
2. Attach the rear stabilizer (3) to the main frame (1) with two bolts (32), two spring washers (34) and two flat washers (33).
3. Tighten the bolts with the tool.
4. If added previously, now remove the styrofoam.

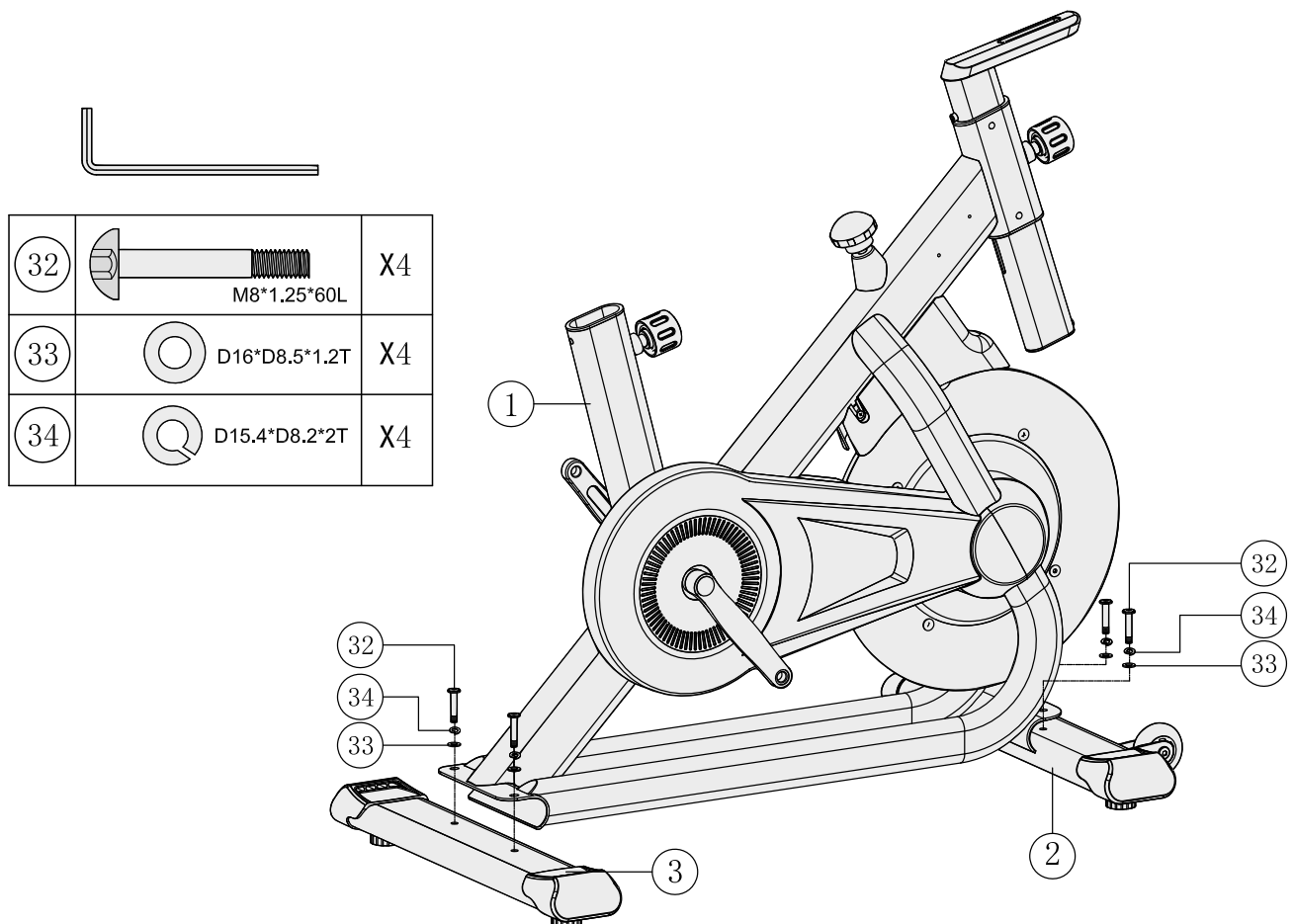



## Step 2: Assembly of the Handlebar, Seat Post and Pedals

1. Attach the handlebar (6) to the front post (5) with one L knob (90) and one flat washer (91).
2. Insert the seat post (4) into the main frame (1) by unscrewing and then pulling the L knob (50).



### CAUTION

In the following step, make sure the knob (50) audibly engages in one of the adjustment holes of the seat post (4).

3. Release the L knob (50), make sure it engages in one of the adjustment holes on the seat post (4) and retighten the knob (50).



### CAUTION

In the following step, make sure to screw in the pedals completely.

4. Attach the right pedal (23R) to the right crank (17R) with the wrench by turning clockwise.
5. Attach the left pedal (23L) to the left crank (17L) with the wrench by turning counterclockwise.

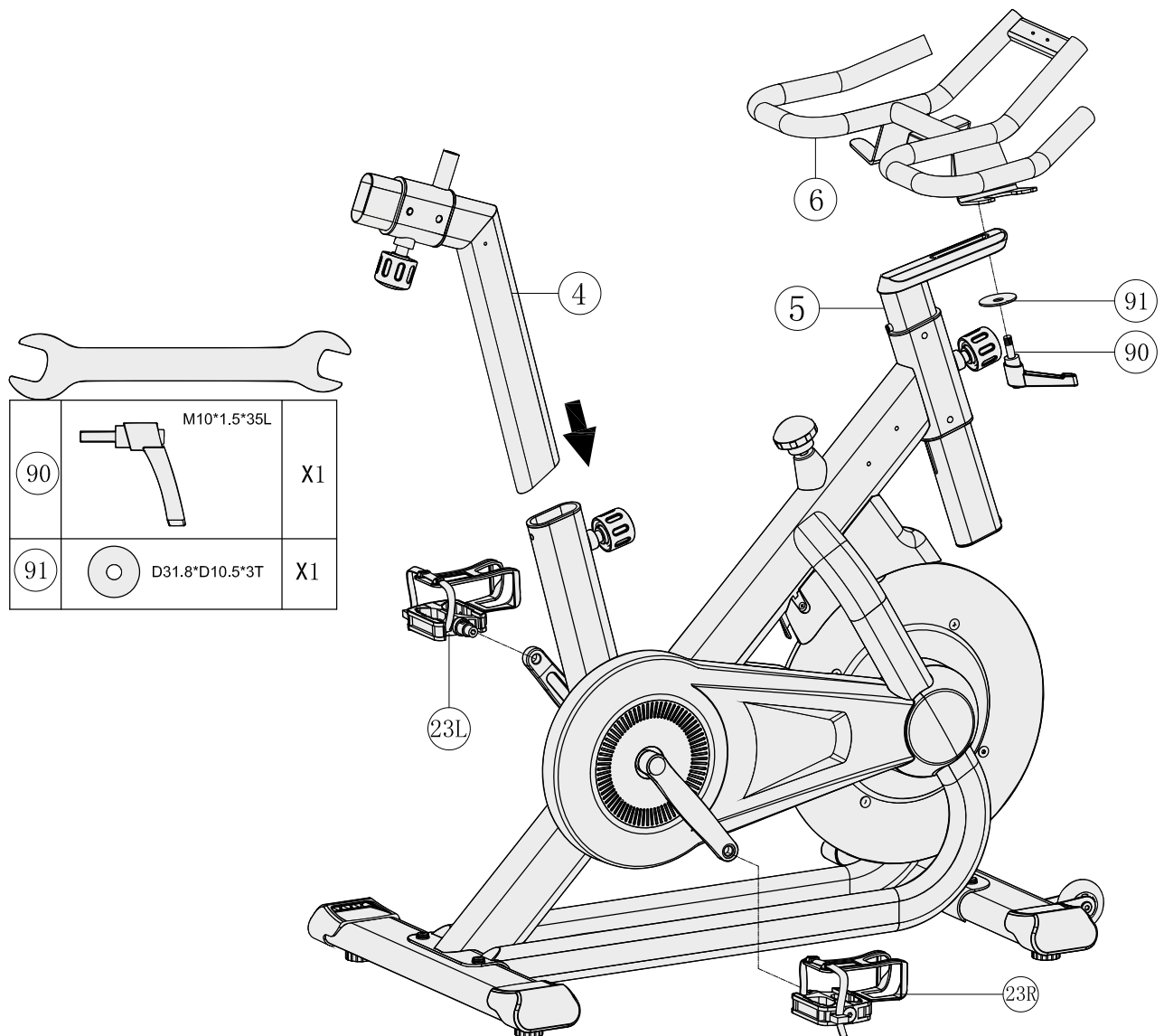

### Step 3: Assembly of the Computer Fixing Plate, Bottle Holders, Seat and Protective Covers

1. Attach the computer fixing plate (9) to the handlebar (6) with two bolts (88) and two flat washers (89).
2. Attach the left and right bottle holders (82L & 82R) to the main frame (1) with two screws (69) each.
3. Slightly loosen the bolt connection underneath the seat (60).
4. Attach the seat (60) to the seat post (4) and retighten the bolt connection with the wrench.
5. Attach the left and right seat protective covers (12L & 12R) to the seat post (4) with one screw (69) each.
6. Tighten the bolts and screws with the tools.

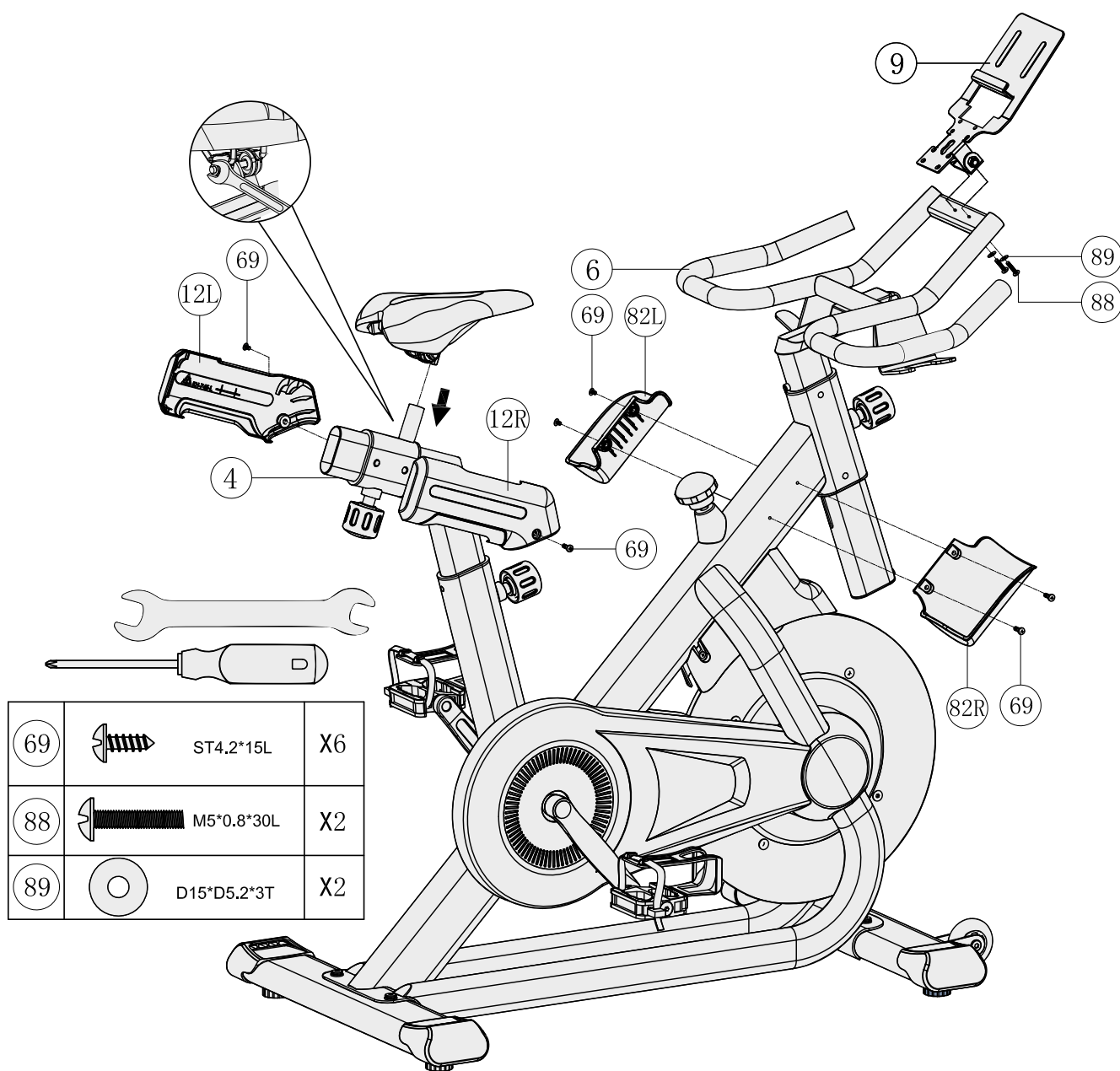

## Step 4: Assembly of the Computer

1. Remove the four pre-assembled screws (70) from the rear side of the computer (10).

### ► ATTENTION

Make sure not to pinch the cables when performing the following steps.

2. Pull the upper computer cable (104) through the hole of the computer fixing plate (9) as shown in Fig. A.
3. Attach a wire plug (61) to the upper computer cable (104) as shown in figure b and c.
4. Connect the upper computer cable (104) with the cable of the computer (10).
5. Attach the computer (10) to the computer fixing plate (9) with the previously removed screws (70) as shown in Fig. D.
6. Tighten the screws with the tool.

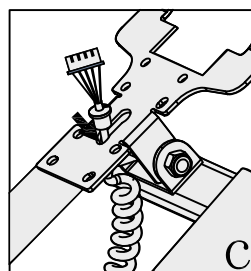
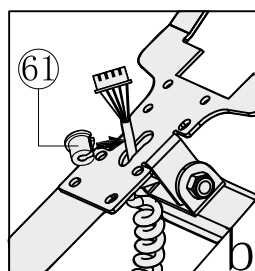
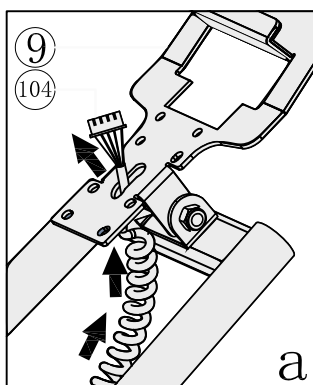

		M5*0.8*15L	X4
		D4*D12*13	X1

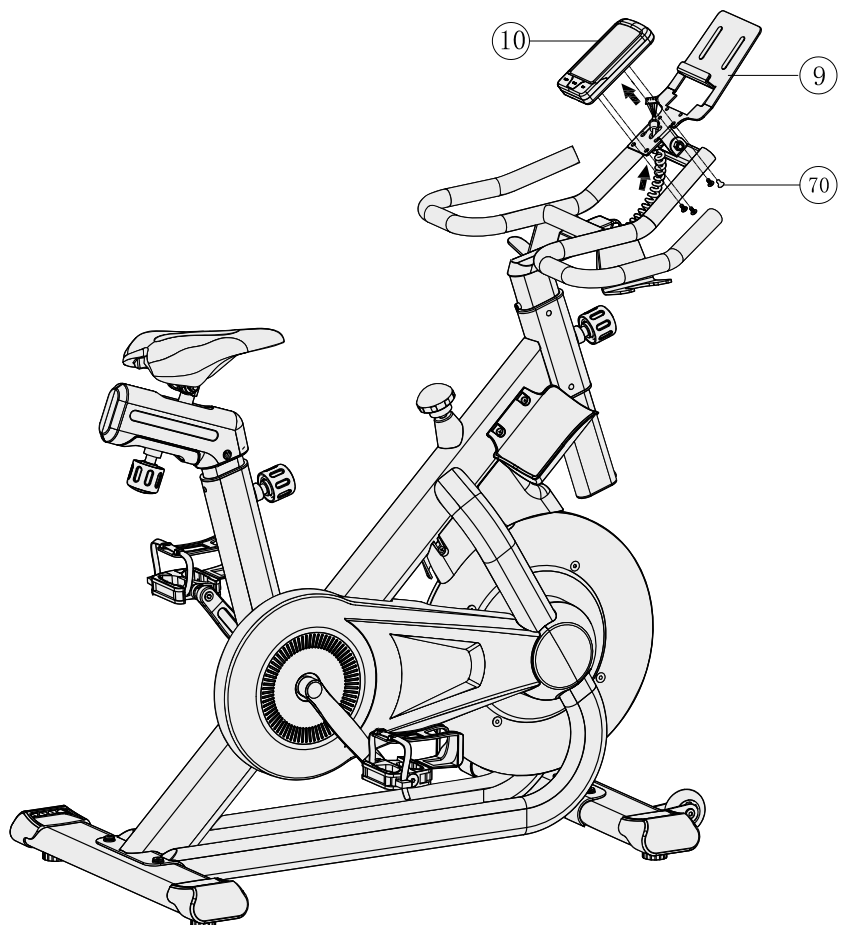
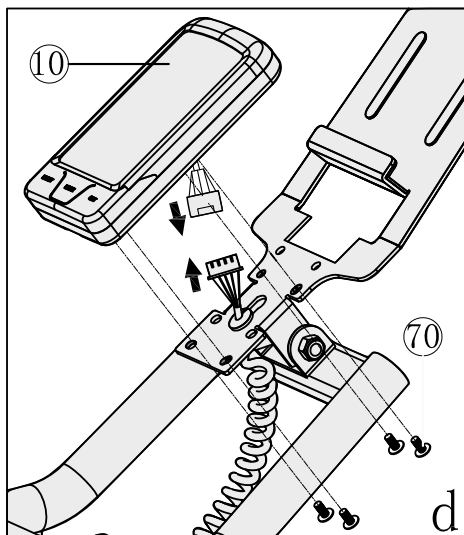

## Step 5: Alignment of the Feet

If the floor is uneven, you can stabilize the equipment by turning the two setting screws under the main frame.

1. Lift the equipment to the desired side and rotate the setting screws under the main frame.
2. Rotate the screws clockwise in order to remove them and to raise the equipment.
3. Rotate them counterclockwise in order to lower the equipment.

## Step 6: Adjustment of the Seat

### Height Adjustment (A-1)



#### CAUTION

The seat post is marked with "STOP" for the minimum insertion depth. When adjusting, make sure not to exceed the minimum insertion depth.

1. Loosen and pull the knob (50) to adjust the height of the seat post.



#### CAUTION

In the following step, make sure the knob audibly engages in one of the adjustment holes.

2. Release the knob (50).
3. Retighten the knob (50).

### Horizontal Adjustment (A-2)

1. Loosen and pull the knob (50) underneath the seat until it can be moved forward and backward.
2. Move the seat into the desired position.



#### CAUTION

In the following step, make sure the knob audibly engages in one of the adjustment holes. Release the knob (50).

3. Reighten the knob (50).

### Tilt Adjustment (A-3)

1. Loosen the bolt connection underneath the seat until the tilt can be adjusted.
2. Adjust the desired tilt.
3. Retighten the bolt connection.

## Step 7: Adjustment of the Handlebar

### Height Adjustment (B-1)



#### CAUTION

The front post is marked with "STOP" for the minimum insertion depth. When adjusting, make sure not to exceed the minimum insertion depth.

1. Loosen and pull the knob (50) to adjust the height of the front post.



#### CAUTION

In the following step, make sure the knob audibly engages in one of the adjustment holes.

2. Release the knob (50).
3. Retighten the knob (50).

### Horizontal Adjustment (B-2)

1. Turn the L knob (90) to the left until the handlebar can be moved.
2. Adjust the handlebar to the desired position.
3. Retighten the L knob (90) by turning it to the right.

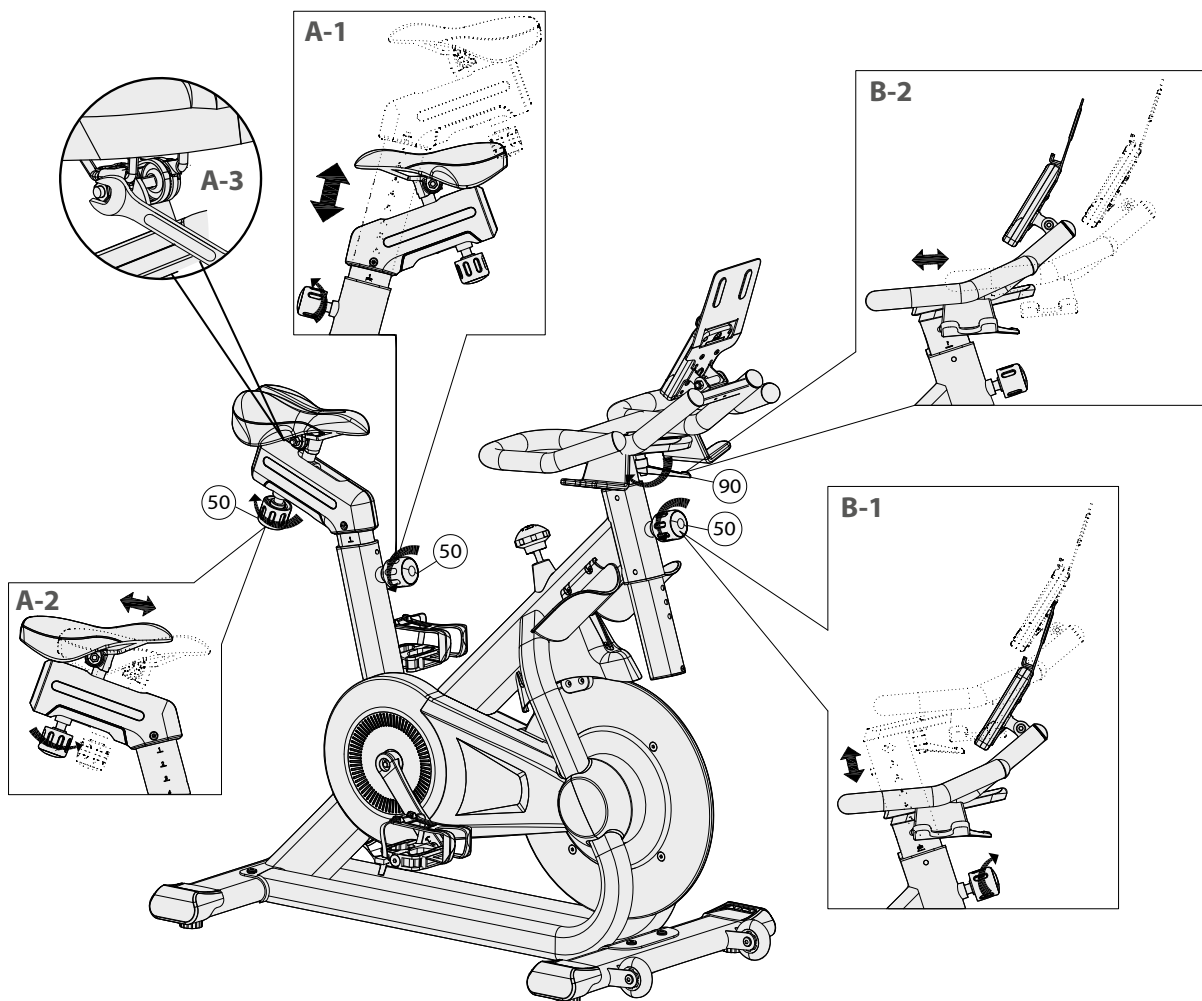

## 2.4 Battery Replacement

1. Open the battery compartment (Fig. A).
2. Remove the batteries (Fig. A).

► **ATTENTION**

Pay attention to the correct pole arrangement in the following step.

3. Insert two new 1.5V AA-batteries (Fig. B).
4. Close the battery compartment (Fig. C).

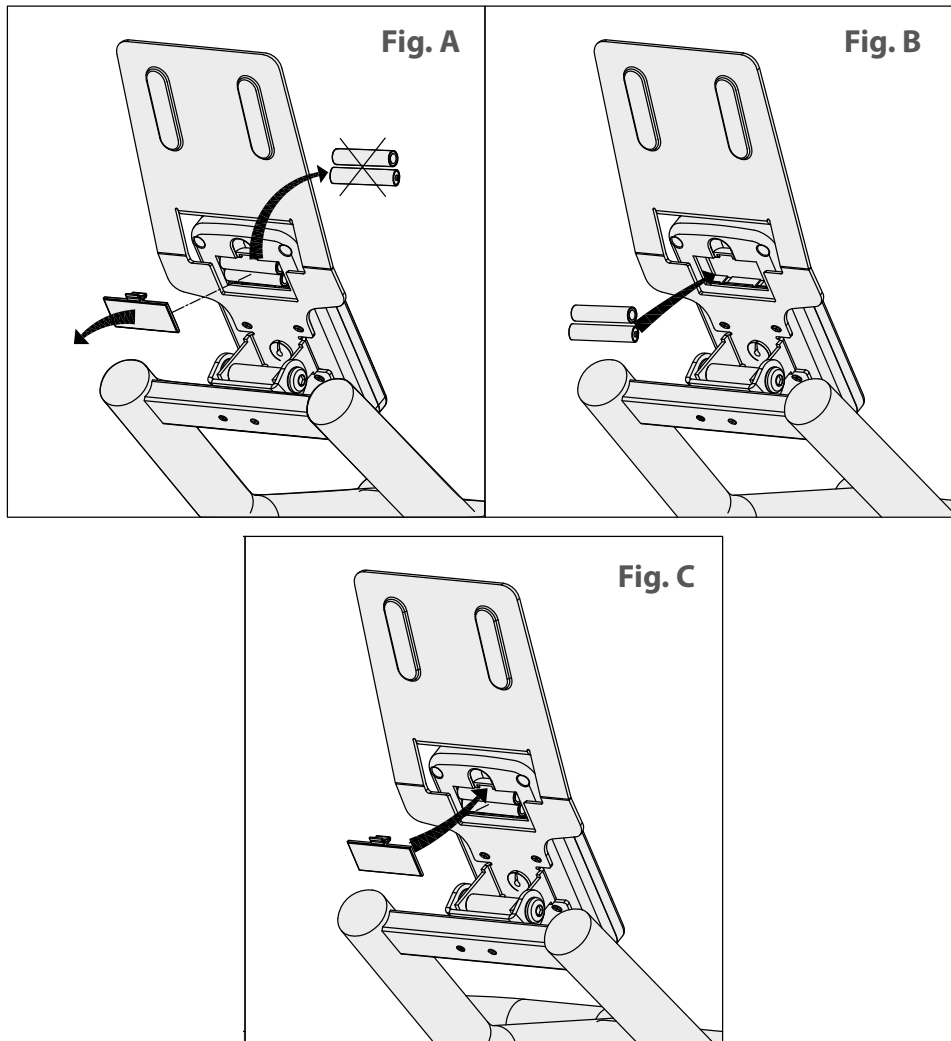

### Correctly Getting On and Off

1. To get on, grip the handles with both hands and first step onto the left pedal with your left foot or onto the right pedal with your right foot and then place your foot onto the other pedal.
2. To get off, grip the handles with both hands and place one foot next to the equipment and then the other foot.

## 3 OPERATING INSTRUCTIONS

### ① NOTICE

- + Familiarise yourself with all the functions and setting options of the device before starting training. Have the proper use of this product explained to you by a specialist.
- + Always start your training with low intensity and increase evenly and gently. End your training with a cool-down phase. If you are unsure, please consult your physician.

### 3.1 Console Display

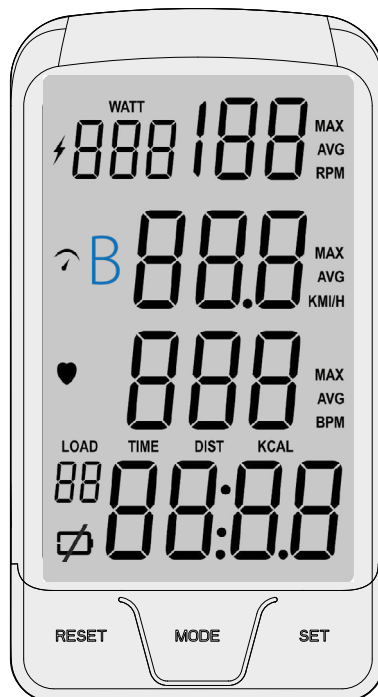

<b>TIME</b>	<ul style="list-style-type: none"> <li>+ Display of the training time in minutes</li> <li>+ Display range: 00:00 - 99:59</li> <li>+ Setting range: 00:00 - 99:00 (in 01:00 min. increments)</li> </ul>
<b>SPEED (KM/H)</b>	<ul style="list-style-type: none"> <li>+ Display of the current speed in km/h</li> <li>+ Display range: 00.0 - 99.9</li> </ul>
<b>RPM</b>	<ul style="list-style-type: none"> <li>+ Display of the current revolutions per minute (RPM)</li> <li>+ Display range: 0 - 999</li> </ul>
<b>DISTANCE (DIST)</b>	<ul style="list-style-type: none"> <li>+ Display of the training distance in km</li> <li>+ Display range: 0.00 - 99.99</li> <li>+ Setting range: 0.00 - 99.50 (in increments of 0.5 km)</li> </ul>

<p><b>CALORIES (KCAL)</b></p>	<p><b>ⓘ NOTICE</b>          These data serve as a rough guide for comparing your training sessions, they must not be used for medical purposes.</p> <ul style="list-style-type: none"> <li>+ Display of burned calories in kcal</li> <li>+ Display range: 0.00 - 9999</li> <li>+ Setting range: 0.00 - 9990 (in increments of 10)</li> </ul>
<p><b>PULSE (BPM)</b></p>	<p><b>⚠ WARNING</b>          Your training equipment is not a medical device. The heart rate measurement of this equipment may be inaccurate. Various factors can affect the accuracy of the heart rate measurement. The heart rate measurement serves only as a training aid.</p> <ul style="list-style-type: none"> <li>+ Display of your current pulse in beats per minute (BPM)</li> <li>+ Display range: 0 - 230</li> <li>+ Setting range: 30 - 230 (in increments of 1)</li> <li>+ Acoustic sound when set target value is exceeded</li> <li>+ A heart symbol blinks when a pulse is detected</li> </ul>
<p><b>WATT</b></p>	<ul style="list-style-type: none"> <li>+ Display of the watt value in watts</li> <li>+ Display range: 0 - 1355</li> </ul>
<p><b>LOAD</b></p>	<ul style="list-style-type: none"> <li>+ Display of the resistance level</li> <li>+ Display range: 1 - 99</li> <li>+ Setting range: 1 - 99</li> </ul>



## 3.2 Button Functions

<b>MODE</b>	<ul style="list-style-type: none"><li>+ Press to enter setting of target values</li><li>+ Press to confirm setting</li><li>+ Press to lock value function when displayed in scan mode</li><li>+ Press and hold for 2 seconds to reset the current setting value to 0</li></ul>
<b>SET</b>	<ul style="list-style-type: none"><li>+ Press once to increase setting by one</li><li>+ Press and hold for fast increase setting</li></ul>
<b>RESET</b>	<ul style="list-style-type: none"><li>+ In MODE or SET, press once to clear current data</li><li>+ Press and hold for 2 seconds for a complete reset</li></ul>
<b>LOAD/EMERGENCY BRAKE (Knob)</b>	<p> <b>WARNING</b> The knob also functions as an emergency brake.</p> <ul style="list-style-type: none"><li>+ Turn to the right to increase the resistance level</li><li>+ Turn to the left to decrease the resistance level</li><li>+ Press and hold down for a full stop (emergency stop)</li></ul>

## 3.3 Emergency Brake



### WARNING

Your equipment has a rigid drive without freewheel. To completely stop the rotation of the pedals and flywheel, the emergency brake must be applied.

The knob, which is centrally located on the main frame, serves as the central control element of the braking system. The knob allows you to apply the emergency brake in order to bring the pedals and the flywheel to a full stop, but also to adjust the training resistance.

### Apply Emergency Brake

To completely stop the rotation of the pedals and the flywheel, press down the knob and keep it pressed until the pedals and flywheel stop moving.

### Adjust the Resistance

1. To increase the resistance, turn the knob to the right.
2. To decrease the resistance, turn the knob to the left.

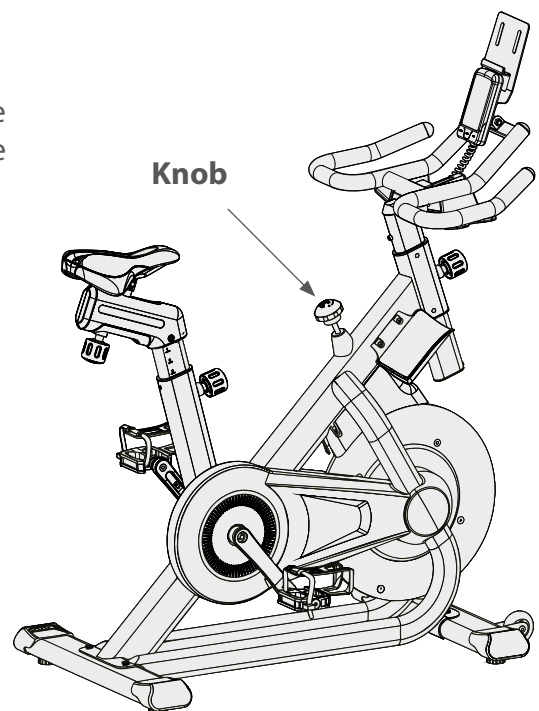

### 3.4 Turning on and Setting Up the Equipment

1. Before turning on the console, make sure the batteries are full and inserted correctly.
2. To start up the console, start pedalling or press any button.

*The LCD display lights up and displays the full screen for 1 second with a beep sound.*

**① NOTICE**

- + If there is no input or movement for 4 seconds, time is paused and the console enters standby mode.
  - + If there is no input or movement for 4 minutes, the console enters sleep mode.
3. When in standby or sleep mode, press any button to restart the console.

### 3.5 Energy Saving Mode

The console enters energy-saving mode (sleep mode) when the pedals have not moved for four minutes. Press any button to restart the console. The training data remains.

**① NOTICE**

If the console does not react, check the batteries and/or if the console cables are properly connected.

## 3.6 Training Instructions

The indoor cycle is equipped with a simple console displaying the most important training data. By default, the parameters time, distance and calories are displayed in an alternation of 5-second intervals. To lock a certain value (time, distance and calories), you can press MODE when the value is displayed. For easy and immediate training, simply start pedalling and the console will display the training data. For a more targeted training, you also have the option of setting target values for the parameters time, distance, calories and pulse.

### 3.6.1 Quick Start Function

1. To start the training without setting any training data, start pedalling.

*The values for time, distance and calories will add up.*

*The values for speed, RPM and Watt will be displayed according to your training input.*

*The value for load will be displayed according to the chosen resistance level.*

#### **① NOTICE**

The value for BPM will only be displayed if a compatible chest strap is used.

2. To adjust the resistance, turn the load knob.
3. To pause the training, stop pedalling.
4. To stop the training, stop pedalling and press and hold down the load knob for a full stop of the pedals and the flywheel.

## 3.6.2 Setting Target Values

You can set target values for time, distance, calories and/or pulse.

### NOTICE

Please note that a compatible chest strap is needed for displaying and setting a value for pulse.

You can enter the settings in the following order: TIME (training time) - DIST (distance) - KCAL (calories) - BPM (pulse).

1. To start up the console, press any button or pedal briefly.
2. To set target values for TIME, DIST, KCAL and/or BPM, press MODE.

*The console switches to training time and "TIME" blinks.*

3. To skip the setting for TIME, press MODE again.
4. To select and enter a value for TIME, press SET.
5. To set the desired training time, press SET (press and hold for fast increase) until the desired value is reached.
6. To confirm the setting and continue with the next parameter, press MODE.

*The console switches to distance and "DIST" blinks.*

7. To skip the setting for DIST, press MODE again.
8. To select and enter a value for DIST, press SET.
9. To set the desired distance, press SET (press and hold for fast increase) until the desired value is reached.
10. To confirm the setting and continue with the next parameter, press MODE.

*The console switches to calories and "KCAL" blinks.*

11. To skip the setting for KCAL, press MODE again.
12. To select and enter a value for KCAL, press SET.
13. To set the desired calorie value, press SET (press and hold for a fast increase) until the desired value is reached.
14. To confirm the setting and continue with the next parameter, press MODE.

*The console switches to pulse and "BPM" blinks.*

### WARNING

Your training equipment is not a medical device. The heart rate measurement of this equipment may be inaccurate. Various factors can affect the accuracy of the heart rate measurement. The heart rate measurement serves only as a training aid. Over-exercise may result in serious injury or death. If you feel faint, stop exercising immediately.

15. To skip the setting for BPM and start the training, press MODE again.
16. To select and enter a value for BPM, press SET.
17. To set the desired pulse, press SET (press and hold for a fast increase) until the desired value is reached.

18. To confirm the setting and start the training and countdown of set target values, press MODE and start pedalling.

*All set values (time, distance and calories) will count down from the set target values to 0.*

*Any remaining target values will count up.*

*The values for speed, RPM and Watt will be displayed according to your training input.*

*The value for the load will be displayed according to the chosen resistance level.*

**① NOTICE**

The value for BPM will only be displayed if a compatible chest strap is used.

*If a target value for BPM has been set, an acoustic sound will signal if the set value is exceeded.*

19. To adjust the resistance, turn the load knob.
20. To pause the training, stop pedalling.
21. When you have reached the first set target value, an acoustic signal will sound.

**→ The training ends.**

22. Stop pedalling and press and hold down the load knob for a full stop of the pedals and the flywheel.

## 3.7 Compatibility Training Apps

This indoor cycle is equipped with a wireless technology interface which allows you to connect the console to different training apps via your mobile device such as a smartphone or tablet. You can find and download the training apps in the app stores of Google or Apple.

### ① NOTICE

- + Your mobile device must be compatible with the wireless technology interface of the indoor cycle.
- + Make sure that wireless technology is activated on your mobile device and that the console is active. To activate the console, simply tap any button.
- + Third-party apps are produced and provided by external manufacturers. Changes and availability of these apps may occur and/or differ. Fitshop holds no responsibility for the availability, functionality or content of these apps.
- + Paid subscriptions may be required for the access and/or full functionality of the training apps.

Your fitness equipment is compatible with several training apps. These include:

- + Kinomap
- + iConsole+
- + ZWIFT
- + MyHomeFIT

1. Make sure that wireless technology is activated on your mobile device and the console of the indoor cycle is active.
2. Open the training app.
3. Select your fitness equipment. You can find the name on a small sticker on the back of the console.
4. Follow the instructions given in the app.

### 3.7.1 Connection with Kinomap

#### ① NOTICE

- + Please note that a paid subscription is required for the full functionality of Kinomap.
  - + Third party apps are produced and provided by external manufacturers. Changes and availability within these apps might occur. Fitshop does not take any responsibility and can not be held liable for the availability, functionality or contents of these apps.
  - + Make sure wireless technology is enabled on your mobile device and the console is active. Otherwise, simply tap any button.
5. Open Kinomap on your mobile device.
  6. On the main screen, select "More" in the bar at the bottom.
  7. Now select "Device management" on this page. Currently connected devices are displayed here.
  8. To add a new device, tap the "+" at the top right.

**① NOTICE**

There may be slight differences in menu navigation between Android and iOS operating systems.

9. Now select the type of device. You can choose from roller trainer, exercise bike, treadmill, cross trainer and rowing machine. For the IC70 Smart, select Indoor Cycle.
10. On the next page, you will see the different brands. Select "Taurus" and then the IC70 Pro Smart.
11. Now all wireless technology sources in the surrounding area are displayed. Select a wireless technology source that begins with i-Console .... The number that follows is also written on a small sticker on the back of the console.

*The device is now added.*

12. Return to the main menu, select a track and enjoy a great track video.

### 3.8 Wireless Technology and Fitness Apps

This console is equipped with a wireless technology interface. Please take note that your mobile device needs to be compatible with the wireless technology interface of the treadmill.

To use training apps you will have to activate the wireless technology function on your mobile device (tablet or smart phone) and start the fitness app. Select your fitness equipment. Please follow the instructions given in the app. You will find the name of your fitness equipment on a small sticker on the back of the console.

You will find the fitness apps in the app stores of Google or Apple. There you will find the apps "Kinomap" or "Zwift". Please note that these apps are produced by an external manufacturer. Fitshop does not take any responsibility regarding the availability, functionality or contents of these programmes.

#### IMPORTANT NOTE

The pre-installed apps are produced and provided by external manufacturers. Changes and availability within these apps might occur. Fitshop does not take any responsibility and can not be held liable for the availability, functionality or contents of these apps. To make sure the pre-installed apps are working correctly, they must be updated regularly. If needed, the respective app will notify you to do so. To update the app, you need a google account. A google email is sufficient. Just follow the instructions on the screen to perform the update.

Please note: The system is set up only for the pre-installed apps. Do not install any additional apps as their proper functionality can not be guaranteed. The installation of other apps might cause technical issues.

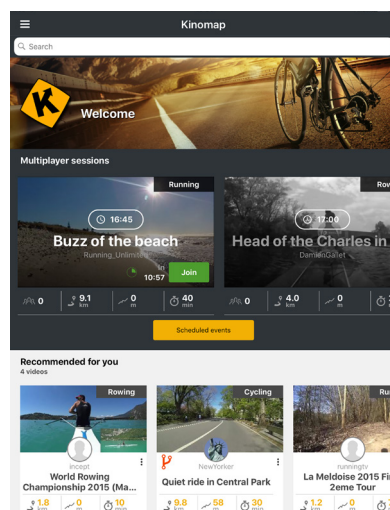
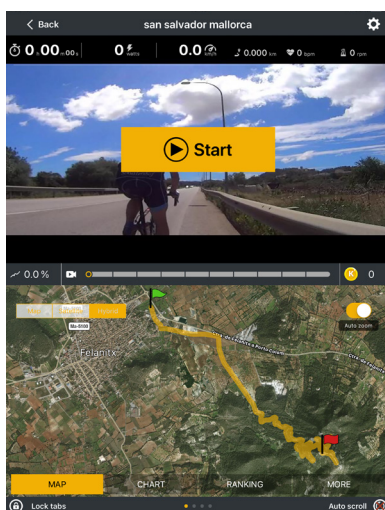
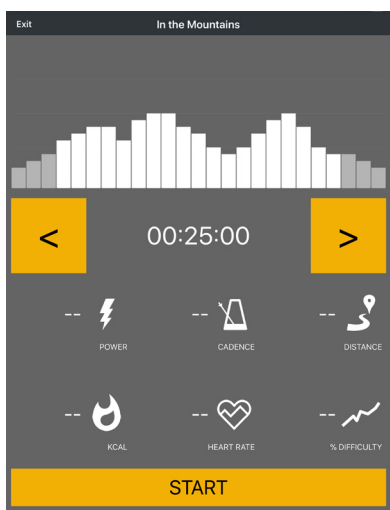

Example: Kinomap



### 4.1 General Instructions

**⚠ WARNING**

- + The storage location should be chosen so that improper use by third parties or children can be prevented.
- + If your equipment does not have transportation wheels, the equipment must be disassembled before transportation.

**▶ ATTENTION**

- + Make sure that the equipment is protected from moisture, dust and dirt in the selected storage location. The storage location should be dry and well ventilated and have a constant ambient temperature between 10°C and 35°C.

### 4.2 Transportation Wheels

**▶ ATTENTION**

If you want to transport your equipment over particularly sensitive and soft floor coverings, such as parquet, planks or laminate, lay out the transport route with cardboard or similar to avoid possible floor damage.

1. Stand behind the equipment and lift it until the weight is transferred to the transportation wheels. After that, you easily can move the equipment to a new position. For long transport distances the equipment should be disassembled and safely packed.
2. Select the new location by following the instructions in the section 1.4 of this manual.

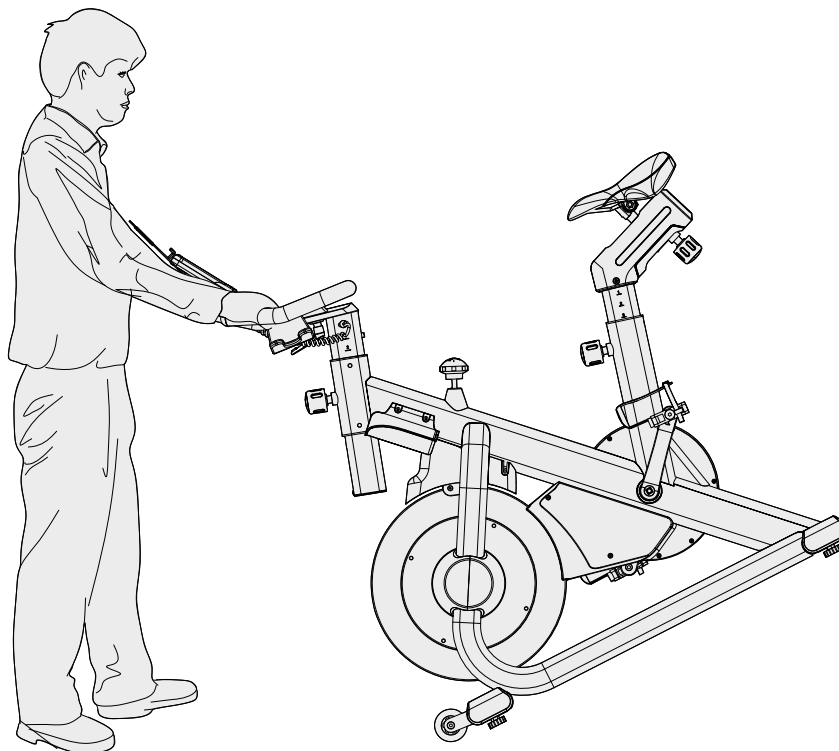

## 5.1 General Instructions



### WARNING

- + Do not make any improper changes to the equipment.



### CAUTION

- + Damaged or worn components may affect your safety and the life of the equipment. Safety can only be guaranteed if you check the equipment regularly for wear and damage. Immediately replace damaged or worn components. In such a case, contact the contract partner. The equipment must not be used until it has been repaired. If necessary, use only original spare parts.

### ATTENTION

- + In addition to the instructions and recommendations for maintenance and care given here, additional service and/or repair work may be necessary; this must only be carried out by authorised service technicians.

## 5.2 Faults and Fault Diagnosis

The equipment undergoes regular quality controls during production. Nevertheless, faults or malfunctions may occur. Frequently, individual parts are responsible for these disturbances, an exchange is usually sufficient. Please refer to the following overview for the most common errors and how to correct them. If the equipment still does not function properly, contact your contract partner.

Fault	Cause	Solution
Cracking in the pedal area	Pedals loose	Tighten the pedals
Equipment wobbles	Equipment is not level	Align the feet
Handlebar/saddle wobbles	Loose screws	Tighten screws firmly
Display is blank/is not working	Batteries empty or loose cable connection	Replace batteries or check cable connections
No pulse display	<ul style="list-style-type: none"> <li>+ Sources of interference in the room</li> <li>+ Unsuitable chest strap</li> <li>+ Wrong position of chest strap</li> <li>+ Chest strap defective or battery empty</li> <li>+ Pulse display defective</li> </ul>	<ul style="list-style-type: none"> <li>+ Eliminate sources of interference (e.g. mobile phone, WLAN, lawn mower and vacuum cleaner robot, etc. ...)</li> <li>+ Use a suitable chest strap (see RECOMMENDED ACCESSORIES).</li> <li>+ Reposition chest strap and/or moisten electrodes</li> <li>+ Changing batteries</li> </ul>

## 5.3 Error Codes and Troubleshooting

The electronics of the equipment continuously carries out tests. In case of deviations, an error code appears on the display and normal operation is stopped for your safety.

**Please contact the contract partner for technical support.**

## 5.4 Maintenance and Inspection Calendar

To avoid damage from body sweat, the equipment must be cleaned with a damp towel (no solvents!) after each training session.

The following routine tasks must be performed at the specified intervals:

Part	Weekly	Monthly
Display console	C	I
Plastic covers	C	I
Screws and cable connections		I
Check pedals for tightness		I
Legend: C = clean; I = inspect		

## 6 DISPOSAL

At the end of its operational life, this equipment cannot be disposed of in normal household waste. Instead, it must be disposed of via an electricals recycling centre. Further information can be obtained from your local authority's recycling service.



The materials can be recycled as per their symbols. Through the reuse, recycling of materials or other forms of recovery of old equipment, you make an important contribution to the protection of the environment.

## 7 RECOMMENDED ACCESSORIES

To make your training experience even more efficient and pleasant, we recommend that you add suiting accessories to your fitness equipment. For indoor cycles this could for example be a **floor mat**, which makes your fitness equipment stand more securely and also protects the floor from sweat or **silicone spray** to keep moving parts in good shape. For many indoor bikes it is possible to replace the **saddle** or **pedals**, as these are usually the same mounts used on bicycles.

If you have purchased a fitness machine with pulse training and want to train your heart rate, we strongly recommend that you use a compatible **chest strap**, as this ensures optimum transmission of the heart rate.

Our range of accessories offers the highest quality and makes training even better. If you would like to find out more about compatible accessories, please go to the detail page of the product in our webshop (the easiest way is to enter the article number in the search field above) and go to the recommended accessories on this page. Alternatively, you can use the QR-code provided. Of course, you can also contact our customer service: by telephone, e-mail, in one of our branches or via our social media channels. We will be happy to advise you!



chest strap



floor mat



lubricant

## 8.1 Serial Number and Model Name

In order to provide you with the best possible service, please have the model name, article number, serial number, exploded drawing and parts list ready. The corresponding contact options can be found in chapter 10 of this operating manual.

**NOTICE**

The serial number of your equipment is unique. It's located on a white sticker. The exact position of this sticker is shown in the following illustration.

Enter the serial number in the appropriate field.

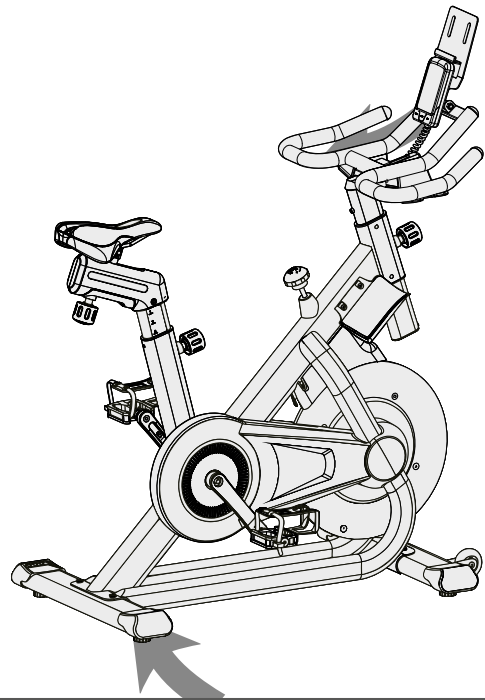

**Serial number:**

**Brand / Category:**

**Model Name:**

**SKU:**

## 8.2 Parts List

No.	Name	Supplier Parts No.	Specification	Qty.
1	Main frame	850A1-3-1000-J4		1
2	Front stabilizer	850A1-3-2100-J2		1
3	Rear stabilizer	850A1-3-2112-J2		1
4	Seat post	850A1-3-2200-J3		1
5	Front post	850A1-3-2000-J2		1
6	Handlebar	850A1-3-2400-BB0		1
7	Flywheel	850A1-6-3101-02		1
8	Seat adjustable tube	745S0-3-4000-J4		1
9	Computer fixing plate	850A1-6-2402-J1		1
10	Computer	850A1-6-2501-B2	SI671210-64	1
11	Elliptical base	850A1-6-2173-B0		4
12L	Seat protective cover(Left)	746S0-6-2282-B1		1
12R	Seat protective cover(Right)	746S0-6-2283-B1		1
13	Belt	58004-6-1128-00	540 (1372) ,pj7	1
14	Pulley	58008-6-1042-D0	D260*21*2T	1
15	Crank axle	850A1-3-2903-00		1
16	Bearing#6004-2RS(C0)	58006-6-1040-01	#6004-2RS(C0)	2
17L	Left crank	58007-6-1097-D0		1
17R	Right crank	58007-6-1098-D0		1
18	Bolt cover	81502-6-2779-B0		2
19	Anti-loosen nut M10*1.25*10T	70501-6-2775-N0	M10*1.25*10T	2
20	C-clip(D22.5*D18.5*1.2T)	55519-1-2312-DA	D22.5*D18.5*1.2T	2
21	Waved washer(D27*D20.3*0.5T)	55120-5-2705-DA	D27*D20.3*0.5T	1
22	Flat washer(D26*D21*1.5T)	55120-1-2615-NA	D26*D21*1.5T	1
23L/23R	Pedal set(L&R)	58029-6-1160-B2	JD-005,9/16"	1
24	Allen bolt M6x1.0x15L	50106-5-0012-C0	M6x1.0x15L	4
25	Nylon nutM6x1.0x6T	55206-1-2006-CA	M6x1.0x6T	5
26	Bearing(#6002-2RS)	58006-6-1014-00	#6002-2RS	2
27	C-clipS-15,1T	55515-1-0010-D0	S-15,1T,15	2
28	Flywheel shaft	850A1-6-3171-00	D15*135L	1

29	Fixed ring	71600-6-3178-B0	D13*D10*1.9	1
30	Anti-loosen nut 3/8"-26UNFx6.5T	18600-6-3175-N1	3/8"-26UNFx6.5T	2
31	Allen nut D9.5x8T	55295-2-3008-NA	D9.5x8T(3/8"- 26UNFx8T)	1
32	Allen bolt M8x1.25x60L	50308-5-0060-F3	M8x1.25x60L	5
33	Flat washerD16xD8.5x1.2T	55108-1-1612-FA	D16xD8.5x1.2T	4
34	Spring washer D15.4xD8.2x2T	55108-2-1520-FA	D15.4xD8.2x2T	4
35	Adjustable wheel	76100-6-2174-B0	D50*M10*1.5	4
36	Allen nut M10*1.5*8T	55210-2-2008-NA	M10*1.5*8T	4
37	Round wheel	84302-6-2175-00	D70.5*23	2
38	Allen bolt M8*1.25*40L	50308-5-0040-F3	M8*1.25*40L	2
39	nylon nut M8*1.25*8T	55208-1-2008-FA	M8*1.25*8T	3
40	Hollow pipe plug	55302-6-4080-B2	40x80x129	1
41	Inner tube	74550-6-1071-B1	40*80*39L	4
42	Cover of brake	850A1-6-1031-00		1
43	Ball knob	52908-2-0045-R1	D59*45*M8	1
44	Screw stem	850A1-6-1084-N1	D10*215L	1
45	Fixed tube	850A1-6-2113-B1	D16*D10.5*69L	1
46	Bushing tube	850A1-6-2118-B2	D16*D10.5*43L	1
47	Sop plate	850A1-6-4073-00	20*20*15L	1
48	Positioning block	850A1-6-2082-00	16.5*16.5*15L	1
49	Allen nut M8*1.25*6T	55208-2-2006-NA	M8*1.25*6T	1
50	Round knob	737L6-6-2284-B0	D50*M16*1.5*22	3
51	Cup nutM10*1.5*18L	55210-3-2018-FA	M10*1.5*18L	1
52	Allen nutM10*1.5*8T	55210-2-2008-FA	M10*1.5*8T	1
53	Bearing#99502	58006-6-1016-00	#99502	2
54	C-clipS-16(1T)	55516-1-0010-00	S-16(1T)	1
55	Waved washer D21*D16*0.3T	55116-5-2103-DA	D21*D16*0.3T	1
56	Idle wheel shaft	850A1-6-1602-01	D22*33.5L	1
57	Flat washer D24*D11*3T	55110-1-2430-NA	D24*D11*3T	1
58	Bolt M10*1.5*20L	50110-2-0020-UN0	M10*1.5*20L	1
59	Adjustable screw stem	850A1-6-3302-F0	1/4"-20UNC*59L	1
60	Seat	58001-6-1423-B0		1

61	Wire plug	55312-1-0015-BA	D4*D12*13	4
62	Screw M5*0.8*10L	54805-2-0010-N0	M5*0.8*10L	1
63	Left chaincover	850A1-6-4501-B0		1
64	Right chaincover	850A1-6-4502-B0		1
65	Hole cover of chain cover	850A1-6-4505-B0		1
66	Front left decorative cover	850A1-6-4523-B0		1
67	Front right decorative cover	850A1-6-4546-B0		2
68	Flywheel cover	850A1-6-4528-B0		1
69	ScrewST4.2*15L	52842-2-0015-F0	ST4.2*15L	15
70	ScrewM5x0.8x15L	52605-5-0015-F0	M5x0.8x15L	6
71	Round cross bolt	50935-2-0012-F0	ST3.5*1.41*12L	7
72	ScrewST4.2*8L	55042-2-0008-F0	ST4.2*8L	1
73	Bolt M6*1*45L	54006-5-0045-F3	M6*1.0*45L	1
74	Flywheel(2)	850A1-6-3103-01	D420*10	1
75	Magnet fixing bracket	850A1-6-3231-J2		1
76	Brake pad	850A1-6-2678-B2		1
77	Cow leather	850A1-6-1088-01	31*22*3T	1
78	ScrewM5*0.8*8L	51605-5-0008-F0	M5*0.8*8L	5
79	Magnet	58009-6-1015-00	D25*7T	4
80	Magnet cover	850A1-6-3272-B0	62*33*12	2
81	Spring	58003-6-1079-N2	D1.2*D9.6*35L	1
82L	Bottle holder(left)	850A1-6-2091-B1	148*119.8*83.5*5T	1
82R	Bottle holder(right)	850A1-6-2092-B1	148*119.8*83.5*5T	1
83	Bushing	58002-6-1099-00	D22.2*D8.2*7T	4
84	ScrewM6*1*12L	54806-2-0012-F0	M6*1*12L	1
85	Cross screw ST4.2*1.4*15L	55342-2-0015-F0	ST4.2*1.4*15L	1
86	Cap(oval)	55330-3-3171-B8	31*71*30	1
87	Computer fixing plate	850A1-6-2726-J0		1
88	BoltM5x0.8x30L	52605-2-0030-F0	M5x0.8x30L	2
89	Flat washerD15*D5.2*3T	55105-1-1530-FA	D15*D5.2*3T	2
90	L knob	52710-1-0035-N0	M10*35L	1
91	Flat washerD31.8*D10.5*3T	55110-1-3135-FA	D31.8*D10.5*3T	1
92	Protection Strip	815S5-6-2278-B0	50*10*3T	2
93	Buffer strip (1)	850A1-6-2088-B0	85*10*2T	1



94	Buffer strip (2)	815S5-6-2089-B0	85*15*2T	1
95	Open-end wrentch	58030-6-1050-C0	153*6.5T	1
96	Cross screwdriver	58030-6-1058-B0	PH2*100	1
97	Flat washerD18*D8.5*1.0T	55108-1-1810-W8	D18*D8.5*1.0T	2
98	Bushing	24500-6-2704-F0	D13*D8.5*40L	1
99	VR regulator	850A1-6-2583-02	65*15	1
100	Sensor bracket	71900-6-2565-B0	24*22*2.5T	1
101	Adjustable rod	850A1-6-2228-N4	43*2T	1
102	Round cross bolt	50805-2-0012-F0	M5*0.8*12L	1
103	Nylon nut M5*0.8*5T	55205-1-2005-FA	M5*0.8*5T	1
104	Upper computer cable	850A1-6-2572-01	790L	1
105	Round magnet	174R4-6-2574-00		1
106	Screw M8*1.25*15L	51608-5-0015-F0	M8*1.25*15L	4
107	Sensor cable	850A1-6-2576-00	500L	1
108	Cross screw ST3*6L	55629-2-0006-N0	ST3*6L	1
109	Allen cross wrentch	58030-6-1038-N1	M6 *150L	1
110	Lower computer cable	850A1-6-2573-00	200L	1
111	Screw ST4.2*12L	55642-2-0012-N0	ST4.2*12L	2
112	Sliding guide sleeve	850G1-6-2080-00	D12*12	1
113	C-clipS-16(1T)	55512-1-0015-D0	D15.5*D10.8*1T	1
114	Spacer ring	850G1-6-3892-N0	D8*D5*2.5T	1
115	Fixed ring	850G1-6-3778-00	D11*D6.2*4T	2
116	Guide slot	850G1-6-1098-N0	67.3*25*2T	1
117	Screw M5*0.8*8L	81605-5-0008-F0	M5*0.8*6L	4

# 8.3 Exploded Drawing

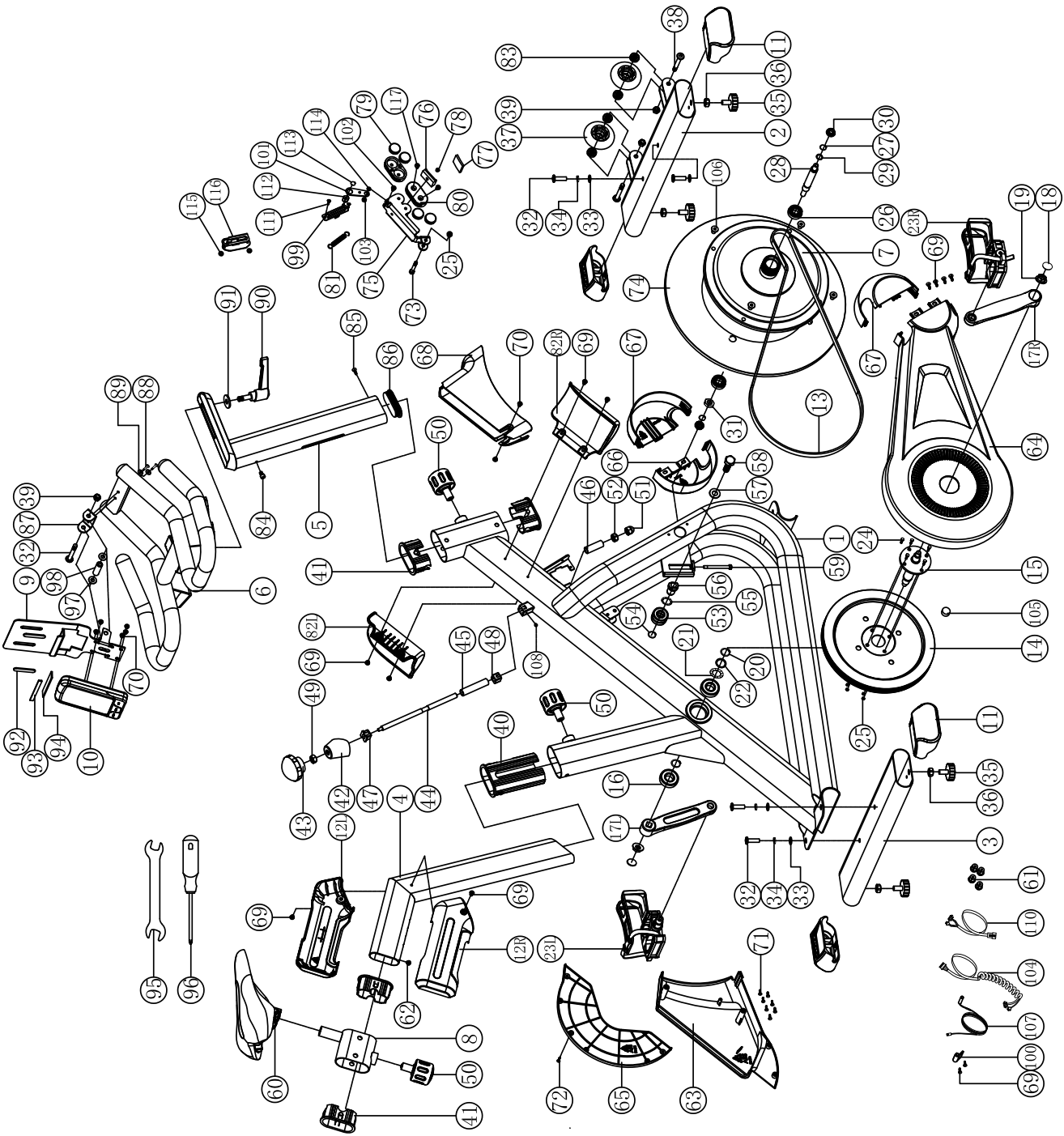

Products from TAURUS® are subject to strict quality control. However, if a fitness equipment purchased from us does not work perfectly, we take it very seriously and ask you to contact our customer service as indicated. We are happy to help you by phone via our service hotline.

### **Error Descriptions**

Your fitness equipment is developed for long-term, high-quality training. However, should a problem arise, please first read the operating instructions. For further assistance, please contact your contract partner or call our service hotline. To ensure your problem is solved as quickly as possible, please describe the defect as exactly as possible.

In addition to the statutory warranty, we provide a warranty for every fitness equipment purchased from us according to the following provisions.

**Your statutory rights are not affected.**

### **Warranty**

The warranty is the first/original buyer.

### **Warranty periods**

The following warranty periods begin on delivery of the fitness equipment.

#### **Warranty period**

The warranty periods, shown on our web shop, begin on delivery of the fitness equipment. The respective warranty periods for your equipment can be found on its product website.

### **Repair Costs**

According to our choice, there will either be a repair, a replacement of individual damaged parts or a complete replacement. Spare parts, that have to be mounted while assembling the equipment, have to be replaced by the warranty holder personally and are not a part of repair. After the expiration of the warranty period, the responsibility for parts costs, repair costs, installation costs and delivery costs lies with the warranty holder.

### **The terms of use are defined as follows:**

- + Home use: solely for private use in private households up to 3 hours per day
- + Semi-professional use: up to 6 hours per day (e. g. rehabilitation centres, hotels, clubs, company gyms)
- + Professional use: more than 6 hours per day (e. g. commercial gyms)

## **Warranty Service**

Within the warranty period, equipment which develops faults as a result of material or manufacturing defects, will be repaired or replaced at our discretion. Ownership of equipment or parts of equipment which have been replaced is transferred to us. The warranty period is not extended nor does a new warranty period begin following repair or replacement under the warranty.

## **Warranty Conditions**

For the warranty to be valid, the following steps must be taken:

Please contact our customer service by email or phone. If the product under warranty has to be sent in for repair, the seller bears costs. After expiry of the warranty, the buyer bears the costs of transport and insurance. If the fault is covered by our warranty, you will receive a new or repaired equipment in return.

## **Warranty claims are invalid in case of damage resulting from:**

- + misuse or improper handling
- + environmental influences (moisture, heat, electrical surge, dust, etc.)
- + failure to follow the current safety measures for the equipment
- + failure to follow the operating instructions
- + use of force (e. g. hitting, kicking, falling)
- + interventions which were not carried out by one of our authorized service centres
- + unauthorised repair attempts

## **Proof of Purchase and Serial Number**

Please make sure that you are able to provide the appropriate receipt when claiming on your warranty. So that we can clearly identify the model of your equipment, and for the purposes of our quality control, you will need to give the serial number of your equipment, when contacting the service team. Where possible please have your serial number and your customer number ready when you call our service hotline. It will help us to deal with your request swiftly.

If you cannot find the serial number on your fitness equipment, our service team is at your disposal to offer further information.







































## **Service outside of the Warranty Period**

We are also happy to issue an individual cost estimate if there is a problem with your fitness equipment after the warranty has expired, or in cases which do not fall under the terms of the warranty, e. g. normal wear and tear. Please contact our customer service team to find a quick and cost-effective solution to your problem. In such a case you will be responsible for the delivery costs.

## **Communication**

Many problems can be solved just by speaking to us as your specialist supplier. We know how important it is to you as a user of the fitness equipment to have problems solved quickly and simply, so you can enjoy working out with minimal interruption. For that reason, we also want to resolve your queries quickly and in a straightforward manner. Thus, please always keep your customer number and the serial number of the faulty equipment handy.

## 10 CONTACT

DE	DK	UK
<p><b>TECHNIK</b></p> <p> +49 4621 4210-900</p> <p> +49 4621 4210-698</p> <p> technik@fitshop.de</p> <p> Öffnungszeiten entnehmen Sie unserer Homepage.</p>	<p><b>TEKNIK OG SERVICE</b></p> <p> 80 90 16 50</p> <p>+49 4621 4210-945</p> <p> info@fitshop.dk</p> <p> Åbningstider kan findes på hjemmesiden: <a href="https://stg.fit/statit7">https://stg.fit/statit7</a></p>	<p><b>CUSTOMER CARE</b></p> <p> +44 141 737 2249 or +44 141 876 3972</p> <p> customercare@fitshop.co.uk</p> <p> You can find the opening hours on our homepage: <a href="https://stg.fit/statitd">https://stg.fit/statitd</a></p>
<p><b>SERVICE</b></p> <p> 0800 20 20277 (kostenlos)</p> <p> 04621 4210 - 0</p> <p> info@fitshop.de</p> <p> Öffnungszeiten entnehmen Sie unserer Homepage: <a href="https://stg.fit/statita">https://stg.fit/statita</a></p>	<p><b>FR</b></p> <p><b>TECHNIQUE &amp; SERVICE</b></p> <p> +33 (0) 189 530984</p> <p>+49 4621 42 10 933</p> <p> info@fitshop.fr</p> <p> Vous trouverez les heures d'ouverture sur notre site Internet: <a href="https://stg.fit/statit4">https://stg.fit/statit4</a></p>	<p><b>BE</b></p> <p><b>TECHNIQUE &amp; SERVICE</b></p> <p> 02 732 46 77</p> <p>+49 4621 4210 933</p> <p> info@fitshop.be</p> <p> Vous trouverez les heures d'ouverture sur notre site Internet: <a href="https://stg.fit/statit8">https://stg.fit/statit8</a></p>
<p><b>ES</b></p> <p><b>TECNOLOGÍA Y SERVICIOS</b></p> <p> 911 238 029</p> <p> info@fitshop.es</p> <p> Consulta nuestro horario de apertura en la página web: <a href="https://stg.fit/statit5">https://stg.fit/statit5</a></p>	<p><b>NL</b></p> <p><b>TECHNISCHE DIENST &amp; SERVICE</b></p> <p> +31 172 619961</p> <p> service@fitshop.nl</p> <p> De openingstijden vindt u op onze homepage: <a href="https://stg.fit/statit3">https://stg.fit/statit3</a></p>	<p><b>INT</b></p> <p><b>TECHNICAL SUPPORT &amp; SERVICE</b></p> <p> +49 4621 4210-944</p> <p> service-int@fitshop.de</p> <p> You can find the opening hours on our homepage: <a href="https://stg.fit/statita">https://stg.fit/statita</a></p>
<p><b>PL</b></p> <p><b>DZIAŁ TECHNICZNY I SERWIS</b></p> <p> 22 307 43 21</p> <p>+49 4621 42 10-948</p> <p> info@fitshop.pl</p> <p> Godziny otwarcia można znaleźć na stronie głównej: <a href="https://stg.fit/statit6">https://stg.fit/statit6</a></p>	<p><b>AT</b></p> <p><b>TECHNIK &amp; SERVICE</b></p> <p> 0800 20 20277 (Freecall)</p> <p>+49 4621 42 10-0</p> <p> info@fitshop.at</p> <p> Öffnungszeiten entnehmen Sie unserer Homepage: <a href="https://stg.fit/statitb">https://stg.fit/statitb</a></p>	<p><b>CH</b></p> <p><b>TECHNIK &amp; SERVICE</b></p> <p> 0800 202 027</p> <p>+49 4621 42 10-0</p> <p> info@fitshop.ch</p> <p> Öffnungszeiten entnehmen Sie unserer Homepage: <a href="https://stg.fit/statit9">https://stg.fit/statit9</a></p>

Please find a detailed overview including address and opening hours for all stores of the Fitshop Group in Germany and abroad on the following website:

[www.fitshop.com/en/stores](http://www.fitshop.com/en/stores)

# WE LIVE FITNESS

## WEBSHOP AND SOCIAL MEDIA

Fitshop is Europe's largest specialist store for home fitness equipment with currently over 70 stores and one of the world's most renowned online mail order companies for fitness equipment. Private customers order via the 25 web shops in the respective national language or have their desired equipment assembled on site. In addition, the company supplies fitness studios, hotels, sports clubs, companies and physio practices with professional equipment for endurance and strength training.

Fitshop offers a wide range of fitness equipment from renowned manufacturers, high-quality in-house developments and comprehensive services, such as a build-up service and sports scientific advice before and after the purchase. The company employs numerous sports scientists, fitness trainers and competitive athletes.

Visit us also on our social media platforms or our blog!

	<a href="http://www.fitshop.co.uk">www.fitshop.co.uk</a> <a href="http://www.fitshop.de/blog">www.fitshop.de/blog</a>
---	--

	<a href="http://www.facebook.com/fitshopgroup">www.facebook.com/fitshopgroup</a>
---	--

	<a href="http://www.instagram.com/fitshopgroup/">www.instagram.com/fitshopgroup/</a>
--	--

	<a href="http://www.youtube.com/@fitshop_uk">www.youtube.com/@fitshop_uk</a>
---	--

**TAURUS**

 cardiostrong

*BODYCRAFT*

 cardiojump

 **DUKEFITNESS**

**DARWIN**



**TAURUS®**