

# TAURUS®

## Assembly and Operating Instructions

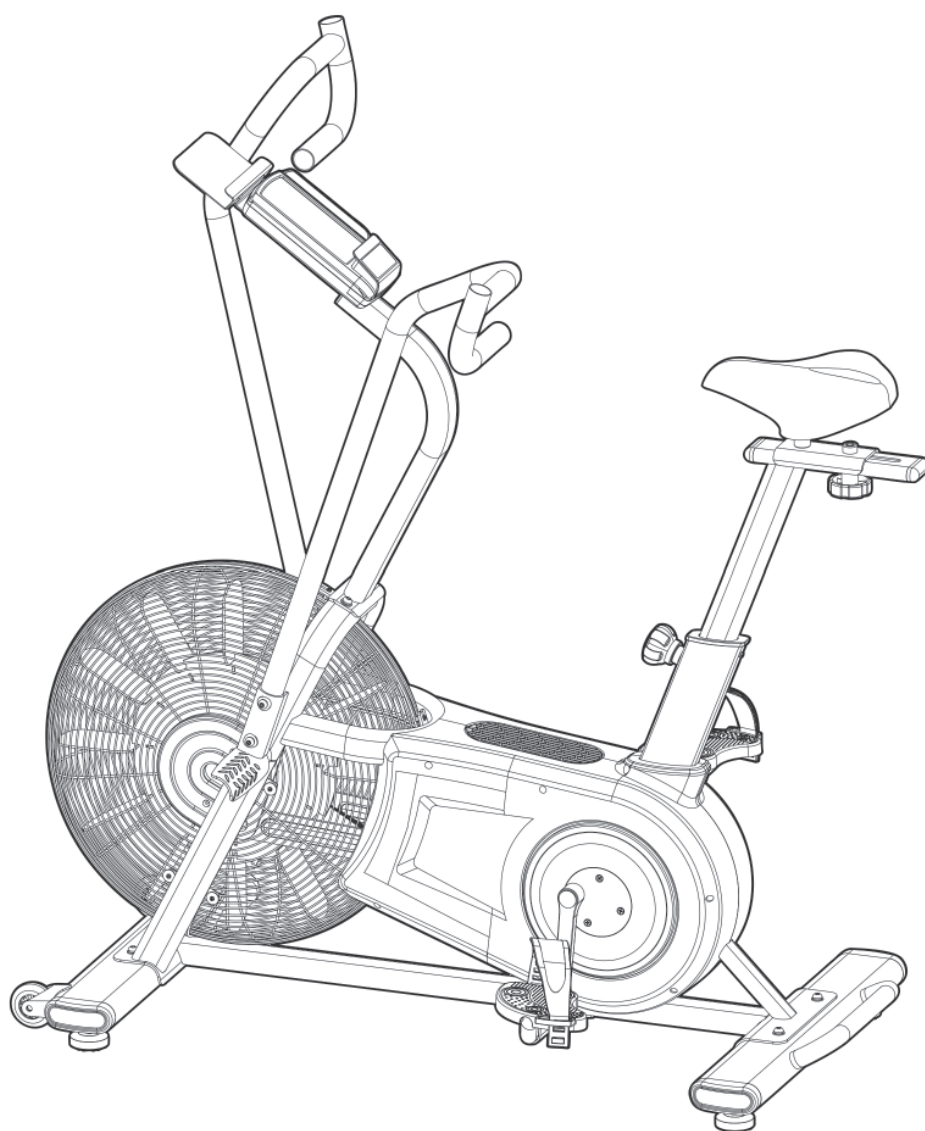

max. 130 kg



~ 45 Min. 



 41 kg

L 128 | W 74 | H 131

FSUKTFAB.01.03

SKU: TF-AB

**Taurus Air Bike**



# Content

<b>1</b>	<b>GENERAL INFORMATION</b>	<b>8</b>
1.1	Technical Data	8
1.2	Personal Safety	9
1.3	Electrical Safety	10
1.4	Set-Up Place	11
<b>2</b>	<b>ASSEMBLY</b>	<b>12</b>
2.1	General Instructions	12
2.2	Scope of Delivery	13
2.3	Assembly	14
2.4	Battery Replacement	20
2.5	Adjusting the Seat Position	21
<b>3</b>	<b>OPERATING INSTRUCTIONS</b>	<b>22</b>
3.1	Console Display	22
3.2	Button Functions	24
3.3	Getting Started	25
3.4	Sleep Mode	25
3.5	Programmes	26
3.5.1	Quick Start Programme	26
3.5.2	Interval 10/20 and Interval 20/10	27
3.5.3	Interval Custom	28
3.5.4	Target Time, Target Distance and Target Calories	30
3.5.5	Target HR	31
3.6	Changing the Units	32
3.7	Workout tips	33
3.7.1	Training clothes	33
3.7.2	Warming up and stretching	33
3.7.3	Medication	34
3.7.4	Used muscle groups	34
3.7.5	Exercise frequency	34
3.8	Workout journal	36
<b>4</b>	<b>STORAGE AND TRANSPORT</b>	<b>37</b>
4.1	General Instructions	37
4.2	Transportation Wheels	37

<b>5</b>	<b>TROUBLESHOOTING, CARE AND MAINTENANCE</b>	<b>38</b>
5.1	General Instructions	38
5.2	Faults and Fault Diagnosis	38
5.3	Error Codes and Troubleshooting	39
5.4	Maintenance and Inspection Calendar	39
<b>6</b>	<b>DISPOSAL</b>	<b>39</b>
<b>7</b>	<b>RECOMMENDED ACCESSORIES</b>	<b>40</b>
<b>8</b>	<b>ORDERING SPARE PARTS</b>	<b>41</b>
8.1	Serial Number and Model Name	41
8.2	Parts List	42
8.3	Exploded Drawing	45
<b>9</b>	<b>WARRANTY</b>	<b>47</b>
<b>10</b>	<b>CONTACT</b>	<b>49</b>

**Dear customer,**

Thank you for choosing quality training equipment from the TAURUS® brand. Taurus offers sports and fitness equipment for home users with high demands on quality, functionality and longevity. Also, Taurus is a well-known and experienced brand for equipping professional rooms for fitness studios and business customers. The focus of Taurus fitness equipment is on what matters most in sports: maximum performance! Therefore, the devices are developed in close consultation with athletes and sports scientists. Because athletes know best what makes perfect fitness equipment.

Further information can be found at [www.fitshop.co.uk](http://www.fitshop.co.uk)

**Intended Use**

The equipment may only be used for its intended purpose.

The equipment is suitable for home use and semi-professional use (e.g. hospitals, clubs, hotels, schools, etc.). The equipment is not suitable for commercial or professional use (e.g. fitness studio).

**Legal Notice**

Fitshop GmbH  
Europe's No. 1 for home fitness

International Headquarters  
Flensburger Straße 55  
24837 Schleswig  
Germany

Management:  
Christian Grau  
Sebastian Campmann  
Dr. Bernhard Schenkel  
No. HRB 1000 SL  
Local Court Flensburg  
European VAT Number: DE813211547

**Disclaimer**

© TAURUS is a registered brand of the company Fitshop GmbH. All rights reserved. Any use of this trademark without the explicit written permission of Fitshop is prohibited.

Product and manual are subject to change. Technical data can be changed without advance notice.

**FITSHOP**

Europe's No.1 for Home Fitness

## ABOUT THIS MANUAL

Please carefully read the entire manual before installation and first use. The manual will help you to quickly set up the system and explains how to safely use it. Make sure that all persons exercising with the equipment (especially children and persons with physical, sensory, mental or motor disabilities) are informed about this manual and its contents in advance. In case of doubt, responsible persons must supervise the use of the equipment.

Due to ongoing changes and software optimisations, the manual may have to be updated. If you notice any discrepancies during assembly or use, please refer to the manual uploaded to the webshop. The latest manual is always available there.



This equipment has been manufactured according to the latest safety knowledge. As far as possible, potential safety hazards which could cause injury have been eliminated. Make sure to carefully follow the instructions and that all parts are securely in place. If required, read through the instructions again to correct any mistakes.

Training devices must be classified according to accuracy and use. Accuracy classes are only applicable to devices that display training data.

### Accuracy classes

Class A: high accuracy.

Class B: medium accuracy.

Class C: low accuracy.

The use classes explain the intended use of the training device.

### Use classes

**Class S** (studio): professional and/or commercial use.

These training devices are intended for the use in training rooms of facilities such as sports clubs, school facilities, hotels, clubs and studios whose access and supervision is specifically regulated by the owner (person with legal responsibility).

**Class H** (home use): use at home.

These stationary training devices are intended for the use in private homes where access to the training device is regulated by the owner (person with legal responsibility).

Please pay close attention to the safety and maintenance instructions given here. The contract partner cannot be held liable for damage to health, accidents or damage to the equipment when it is not used in accordance with these instructions.

The following safety instructions may appear in this manual:

► **ATTENTION**

This notice indicates potentially hazardous situations which, if not avoided, may result in property damage.

⚠ **CAUTION**

This notice indicates potentially hazardous situations which, if not avoided, may result in slight or minor injuries!

⚠ **WARNING**

This notice indicates potentially hazardous situations which, if not avoided, may result in death or serious injuries!

⚠ **DANGER**

This notice indicates potentially hazardous situations which, if not avoided, will result in death or serious injuries!

ⓘ **NOTICE**

This notice indicates further useful information.

Retain these instructions in a safe place for future reference, maintenance or when ordering replacement parts.

## 1.1 Technical Data

### LCD display of

- + training distance in km
- + calories burnt in kcal
- + heart rate (when using the hand sensors or a chest strap)
- + Watt
- + cadence (rotations per minute)
- + speed in km/h
- + training time in min
- + target heart rate

### Resistance system:

### Air resistance system

Programmes in total:	8
Quick Start programme:	1
Interval programmes:	3 (one of them user-defined)
Target programmes:	3
Heart rate controlled programme:	1

### Weight and dimensions:

Article weight (gross, including packaging):	46.5 kg
Article weight (net, without packaging):	40.7 kg
Packaging dimensions (L x W x H):	ca. 120 cm x 37 cm x 66 cm
Set-up dimensions (L x W x H):	ca. 128 cm x 74 cm x 131 cm
Maximum user weight:	130 kg
Class:	S



## 1.2 Personal Safety

### **DANGER**

- + Before you start using the equipment, you should consult your physician that this type of exercise is suitable for you from a health perspective. Particularly affected are persons who: have a hereditary disposition to high blood pressure or heart disease, are over the age of 45, smoke, have high cholesterol values, are overweight and/or have not exercised regularly in the past year. If you are under medical treatment that affects your heart rate, medical advice is absolutely essential.
- + Note that excessive training can seriously endanger your health. Please also note that heart rate monitoring systems can be inaccurate. If you notice any signs of weakness, nausea, dizziness, pain, shortness of breath, or other abnormal symptoms, stop exercising immediately and seek advice from your doctor if necessary.
- + The owner must communicate all warnings and instructions to the user.

### **WARNING**

- + This equipment may not be used by children under the age of 14.
- + Children should not be allowed unsupervised access to the equipment.
- + Persons with disabilities must have a medical license and must be under strict observation when using the equipment.
- + The equipment is strictly for use by one person at a time.
- + If your equipment provides a safety key, the clip of the safety key must be attached to your clothing before starting your training. In the event of a fall, the EMERGENCY STOP of the equipment can be initiated.
- + There is a risk of injury from spinning pedals and/or an exposed flywheel in the absence of a freewheel. Never get on or off the equipment when the pedals or the flywheel are still moving. Always make sure that the pedals and the flywheel have come to a complete stop.
- + Support yourself with at least one hand on the handlebar when getting on and off the equipment. Only dismount from the equipment when the pedals have come to a complete stop.
- + Keep your hands, feet and other body parts, hair, clothing, jewellery and other objects well clear of moving parts.
- + During use, wear suitable sports clothing rather than loose or baggy clothing. When wearing sports shoes, make sure they have suitable soles, preferably made of rubber or other non-slip materials. Shoes with heels, leather soles, studs or spikes are unsuitable. Never exercise barefoot.

### **CAUTION**

- + If your equipment needs to be connected to the power supply with a mains cable, make sure that the cable is not a potential tripping hazard.
- + Make sure that nobody is within the range of motion of the equipment during training so as not to endanger you or other persons.
- + Always tighten the pedal strap before you start training to prevent your feet from slipping.

 **CAUTION**

- + Be aware that if adjustment devices are left protruding, they may impede the user's movement.

 **ATTENTION**

- + Do not insert any objects of any kind into the openings of the device.
- + To protect the equipment from use by unauthorised third parties, always remove the power cable when not in use and store it in a safe place that is inaccessible to unauthorised persons (e.g. children).
- + Class B and C crank training equipment is not suitable for high accuracy purposes.

## 1.3 Electrical Safety

 **DANGER**

- + In order to reduce the risk of an electric shock, always unplug the equipment from the mains socket immediately after your workout, before assembly or dismantling, and before maintenance or cleaning. Do not pull on the cable.

 **WARNING**

- + Do not leave the equipment unattended while the mains cable is plugged into the mains socket. During your absence, the mains cable must be removed from the mains socket to prevent improper use by third parties or children.
- + If the mains cable or plug is damaged or defective, contact your contract partner. Until repair, the equipment must not be used.

 **ATTENTION**

- + The equipment requires a mains connection of 220-230 V with 50 Hz mains voltage.
- + The equipment may only be connected directly to an earthed socket using the supplied mains cable. Extension cables must conform to VDE guidelines. Always completely unwind the mains cable.
- + The socket must be protected by a fuse with a minimum fuse rating of "16 A, slow blow".
- + Do not make any changes to the mains cable or the mains plug.
- + Keep the mains cable away from water, heat, oil and sharp edges. Do not route the mains cable underneath the equipment or under a carpet or rug, and do not place any objects on top of it.
- + If your purchased item is equipped with a TFT console, software updates must be carried out regularly. Follow the instructions on the console to perform the update(s).
- + The software systems on gym equipment with TFT consoles are set up only for the pre-installed apps. Do not install any additional apps.

 **NOTICE**

- + The pre-installed apps on TFT consoles are produced and provided by external manufacturers. Fitshop does not take any responsibility for the availability, functionality or contents of these apps.

## 1.4 Set-Up Place

### WARNING

- + Do not place the equipment in main corridors or escape routes.

### CAUTION

- + Choose a location in which to place the equipment such that there is enough free space/clearance to the front, the rear and to the sides of the equipment.
- + The training room should be well ventilated during training and not be exposed to any draughts.
- + Choose the place in which to set up the equipment such that there is enough free space/clearance to the front, the rear and to the sides of the equipment.
- + The free area in the direction from which the exercise equipment is accessed must be at least 0.6 m larger than the exercise area.
- + The set-up and mounting surface of the equipment should be flat, loadable and solid.

### ATTENTION

- + The device may only be used in one building, in sufficiently tempered and dry rooms (ambient temperatures between 10°C and 35°C). The equipment should not be used outdoors or in rooms with high humidity (over 70%) like swimming pools.
- + A floor protective mat/equipment underlay can help to protect high-quality floor coverings (parquet, laminate, cork, carpets) from dents and sweat and can help to level out slight unevenness.
- + For Class S equipment, the exercise equipment may only be used in areas where access, supervision and control are specifically regulated by the owner.

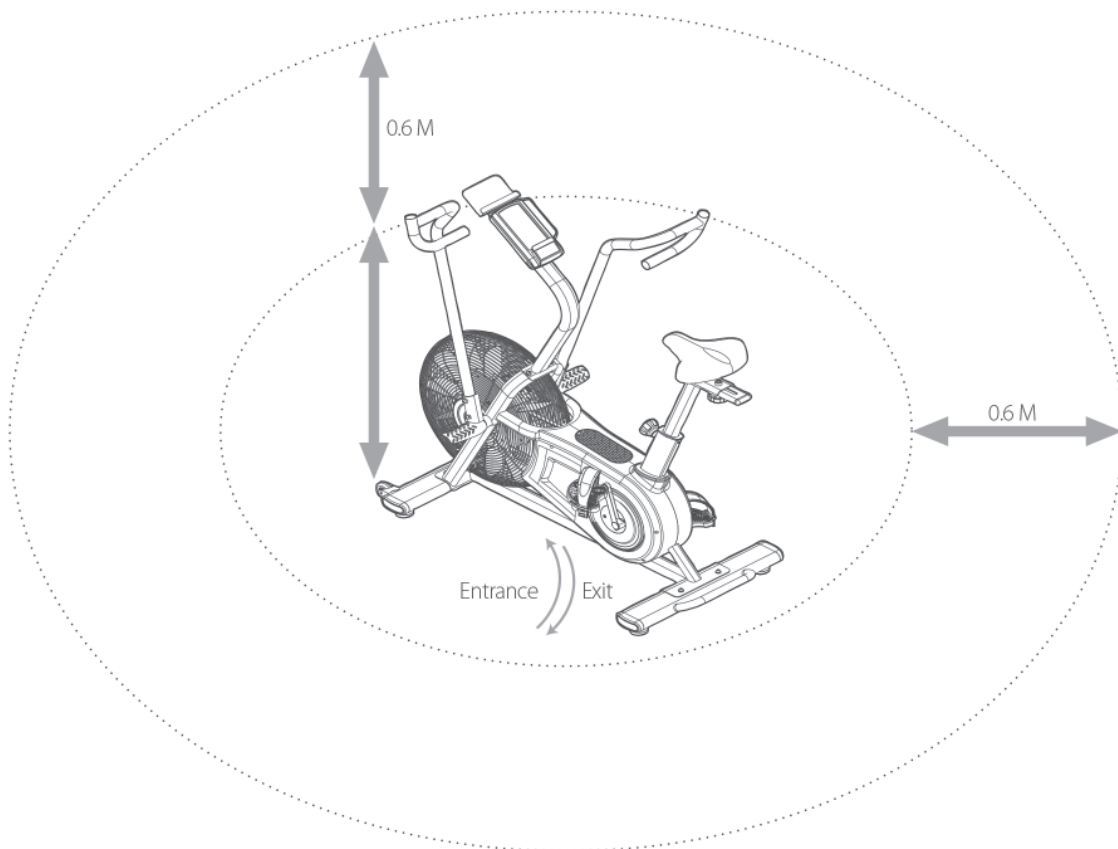

### 2.1 General Instructions



#### **DANGER**

- + Do not leave any tools, packaging materials such as foils or small parts lying around, as otherwise there is a danger of suffocation for children. Keep children away from the equipment during assembly.



#### **WARNING**

- + Pay attention to the instructions attached to the equipment in order to reduce the risk of injuries.



#### **CAUTION**

- + Ensure to have sufficient room for movement in each direction during assembly.
- + The assembly of the equipment must be carried out by at least two adults. If in doubt, seek the help of a third technically skilled person.



#### **ATTENTION**

- + To prevent damage to the equipment and the floor, assemble the equipment on a mat or packaging board.



#### **NOTICE**

- + In order to make the assembly as simple as possible, some screws and nuts to be used can already be pre-assembled.
- + Ideally, assemble the equipment at its later set-up place.

## 2.2 Scope of Delivery

The scope of delivery consist of the following parts. At the beginning, check whether all parts and tools belonging to the device are included in the scope of delivery and whether damage has occurred. In the event of complaints, the contractual partner must be contacted directly.

### CAUTION

If parts of the scope of delivery are missing or damaged, the assembly must not be carried out.

### NOTICE

- + Batteries are not included in the scope of delivery.
- + 2 x AA batteries are required.

Included tools:

- + Allen Wrench
- + Spanner

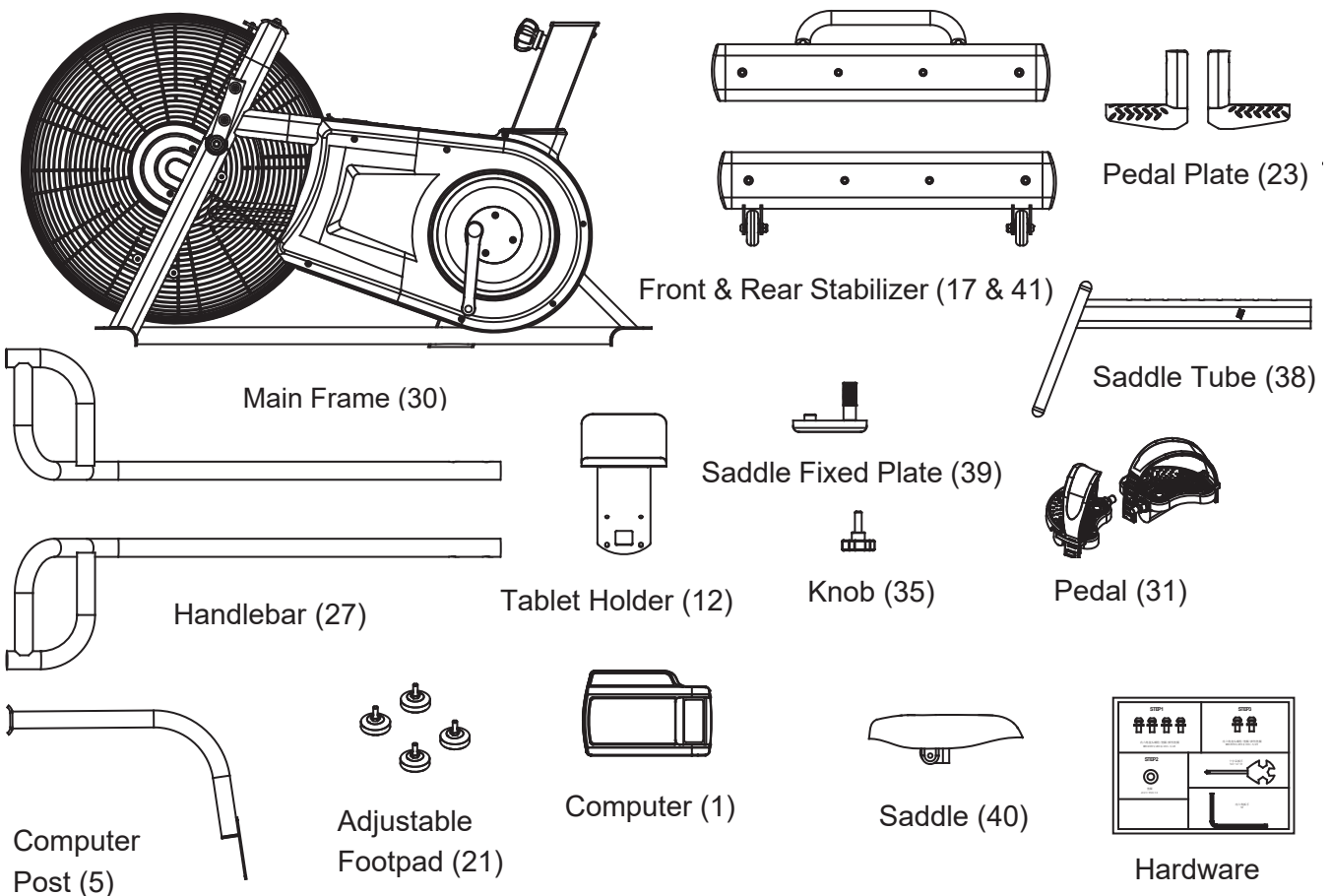

## 2.3 Assembly

Before assembly, take a close look at the individual assembly steps shown and carry out the assembly in the order given.

### **NOTICE**

- + First loosely screw all parts together and check that they fit properly. Tighten the screws using the tool only when you are instructed to do so.
- + If you have difficulty recognising the graphics, we recommend that you open and/or download the PDF instructions stored in the webshop on your end device (e.g. smartphone, tablet or PC). There you have the option of zooming in closer. Please note that the Adobe Acrobat Reader programme must be installed on your end device in order to open the file.

### Step 1: Assembly of the Rear and Front Stabilizer

1. Place the main frame (30) on the ground.
2. Remove the pre-assembled bolts (8), spring washers (9) and washers (7) with an allen wrench (A) from the front stabilizer (17) and rear stabilizer (41).
3. Attach four adjustable foot pads (21) to the front and rear stabilizer (17 & 41).
4. Assemble the front stabilizer (17) and rear stabilizer (41) to the main frame (30) with the four bolts (8), four spring washers (9) and four washers (7) by using the allen wrench (A).

 No. 7 Washer (D8xØ16x1.5) x 4pcs

 No. 8 Bolt (M8x20x55) x 4pcs

 No. 9 Spring Washer (D8) x 4pcs

 No. A Allen Wrench (S5) x 1pc

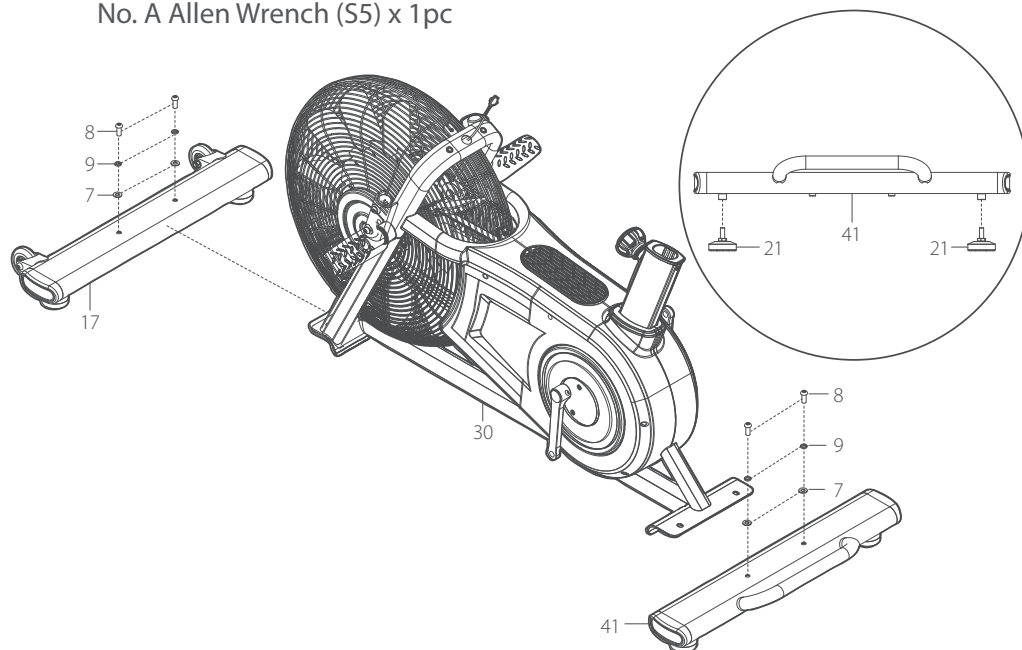

## Step 2: Assembly of the Saddle

1. Insert the saddle tube (38) into the main frame (30) and secure it with the knob (32).
2. Attach the saddle fixed plate (39) to the saddle tube (38) and secure it with a knob (35) and washer (36).
3. Attach the saddle (40) to the saddle fixed plate (39) and tighten it with the spanner (B).

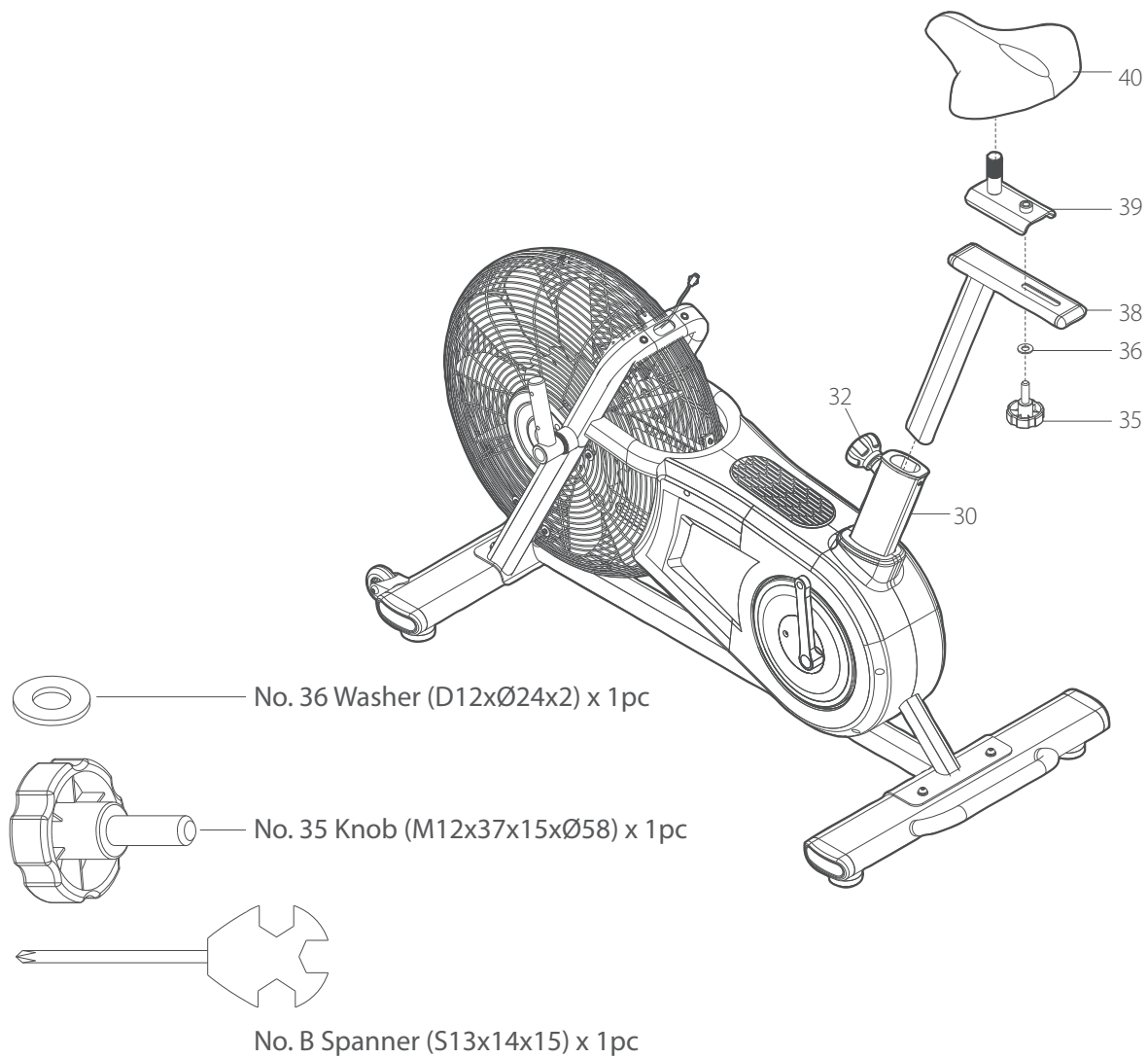



### Step 3: Assembly of the Computer Post and Cables

1. Remove the pre-assembled bolts (8), spring washers (9) and washers (7) from the main frame (30) by using the allen wrench (A).

► **ATTENTION**

Be careful not to pinch the cables in the following step.

2. Connect the sensor wire (62) with the trunk wire (4) and insert the wires into the main frame (30).
3. Assemble the computer post (5) to the main frame (30) with two bolts (8), two spring washers (9) and two washers (7) by using the allen wrench (A).

-  No. 7 Washer (D8xØ16x1.5) x 2pcs
-  No. 8 Bolt (M8x20x55) x 2pcs
-  No. 9 Spring Washer (D8) x 2pcs

 No. A Allen Wrench (S5) x 1pc

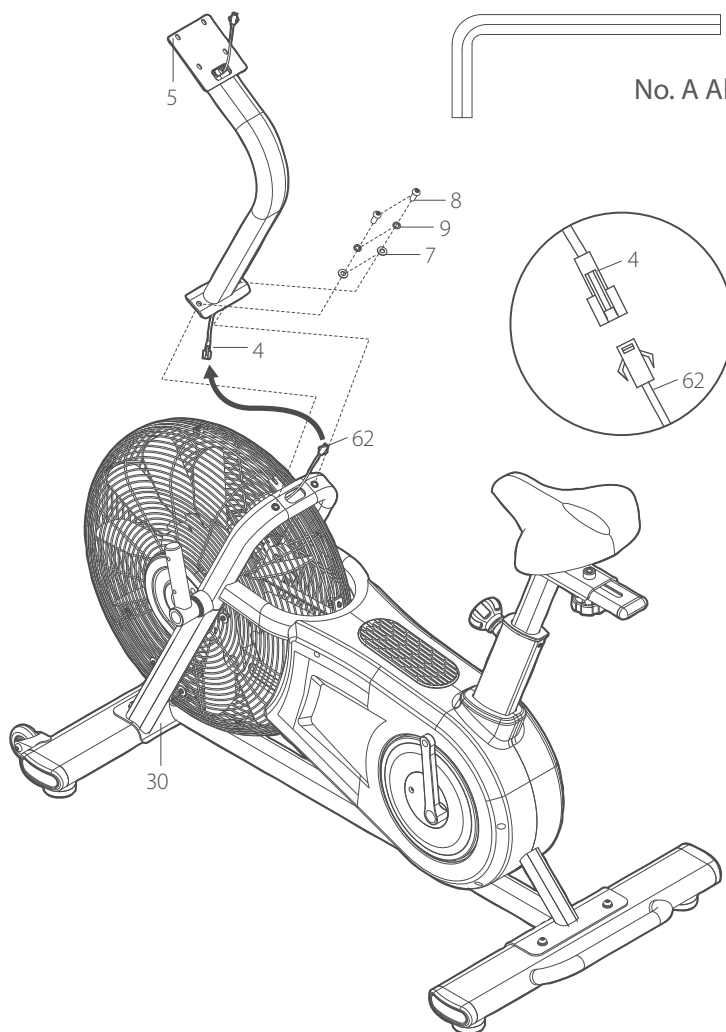



#### Step 4: Assembly of the Computer and Tablet Holder

1. Remove the pre-assembled bolts (2) from the computer (1) by use of the spanner (B).
2. Connect the trunk wire (4) with the computer wire (1a).
3. Assemble the tablet holder (12) and computer (1) to the computer post (5) with four bolts (2) by using the spanner (B).

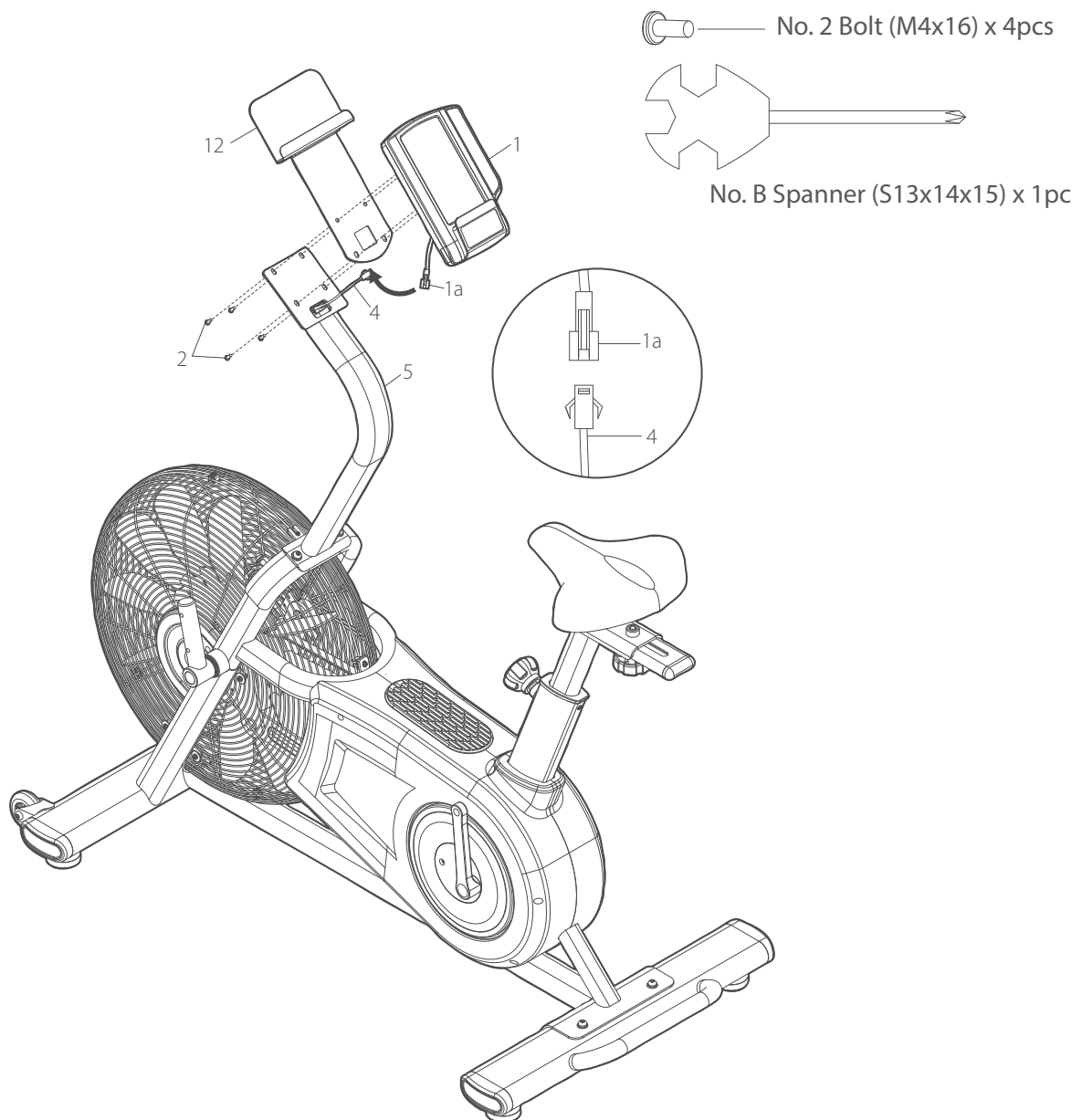

### Step 5: Assembly of the Handlebars

1. Remove the pre-assembled bolt (8), spring washer (9) and arc washer (10) from the swing bars (26) by using the allen wrench (A).
2. Attach the handlebars (27L & 27R) to the swing bars (26).
3. Assemble the pedal plates (23L & 23R) and handlebars (27L & 27R) to the swing bars (26) with four bolts (8), four spring washers (9) and four arc washers (10) by using the allen wrench (A).

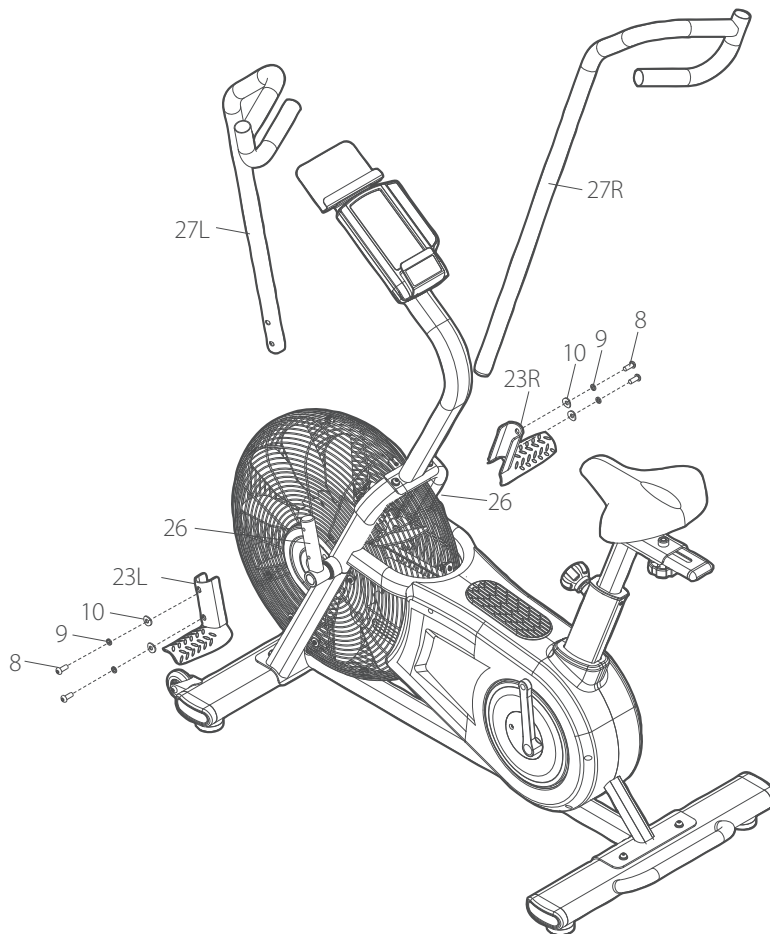
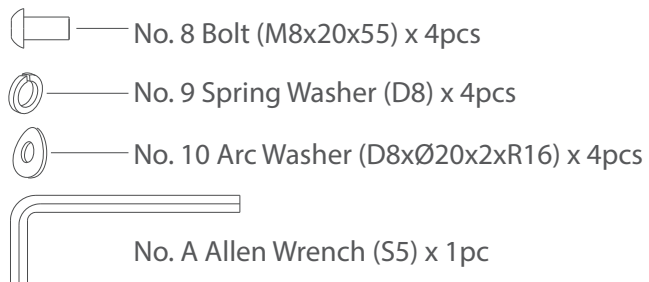

## Step 6: Assembly of the Pedals

1. Turn the left crank (75L) to the upper position.
2. Screw the left pedal (31L) to the left crank (75L) by turning the pedal (31L) counterclockwise.
3. Turn the right crank (75R) to the lowest position.
4. Screw the right pedal (31R) to the right crank (75R) by turning the pedal (31R) clockwise.
5. Tighten the pedals with a spanner (B).



### CAUTION

Make sure to screw in the pedals completely.

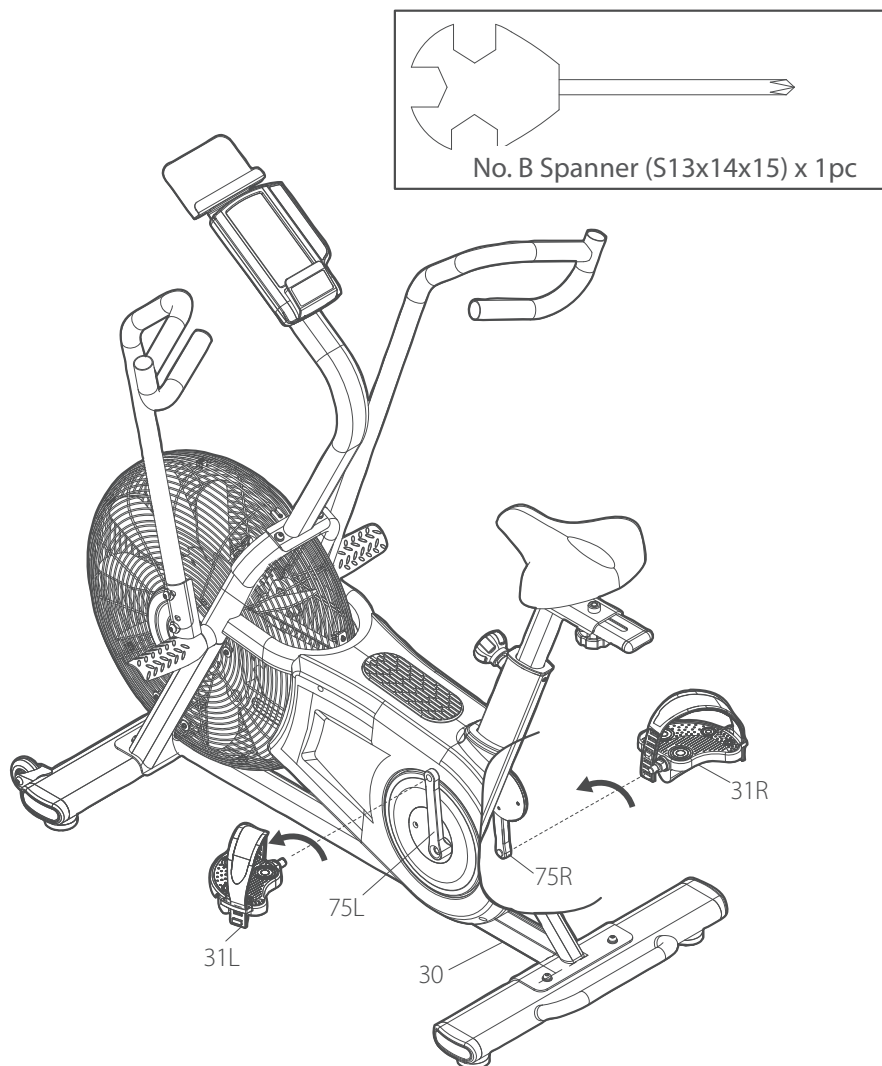

## Step 7: Adjusting the Pedal Straps

1. Loosen the strap from the pedal.
2. Place your foot on the pedal.
3. Secure the strap.

### **NOTICE**

The strap should rest loosely over the ball of the foot and not sit firmly under any circumstances.

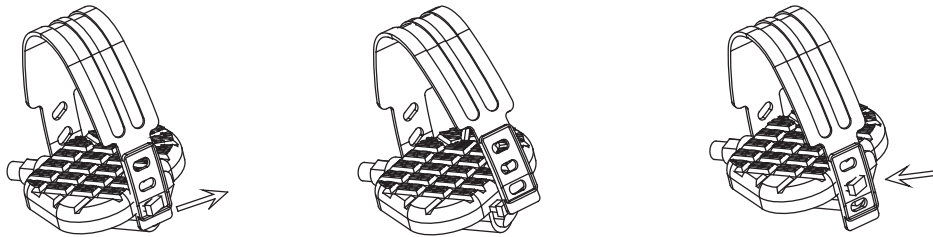

## 2.4 Battery Replacement

The console is powered by two AA 1.5V batteries. In case the console is not working properly, the batteries might be running low. Follow the instructions to exchange the batteries.

### **NOTICE**

Batteries are not included in the scope of delivery.

1. Remove the battery cover from the console (1).
2. Remove the batteries.
3. Insert the new new batteries.
4. Re-insert the battery cover.

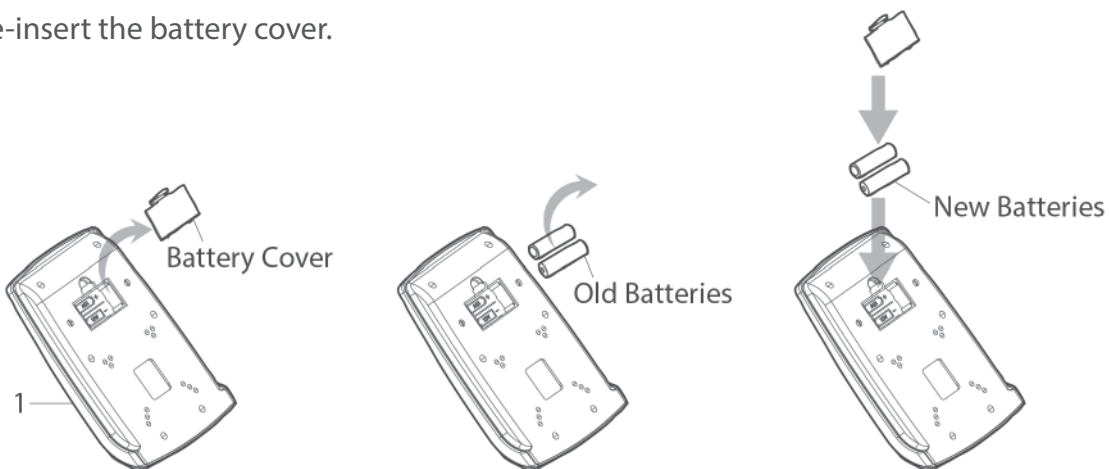

## 2.5 Adjusting the Seat Position

### Vertikal Adjustment:

Rotate the knob (32) counter-clockwise to adjust the height according to the holes on the saddle tube (38). When "MAX" is shown on the saddle tube (38): it is the highest point. Rotate the knob (32) clockwise to fasten and adjust to a suitable position.



### CAUTION

When adjusting, make sure not to exceed the minimum insertion depth.

### Horizontal Adjustment:

Rotate the knob (35) under the seat counter-clockwise until you can move the seat forwards and backwards according to the arrows on the saddle plate (39). Rotate the knob (35) clockwise to fasten and adjust to a suitable position.

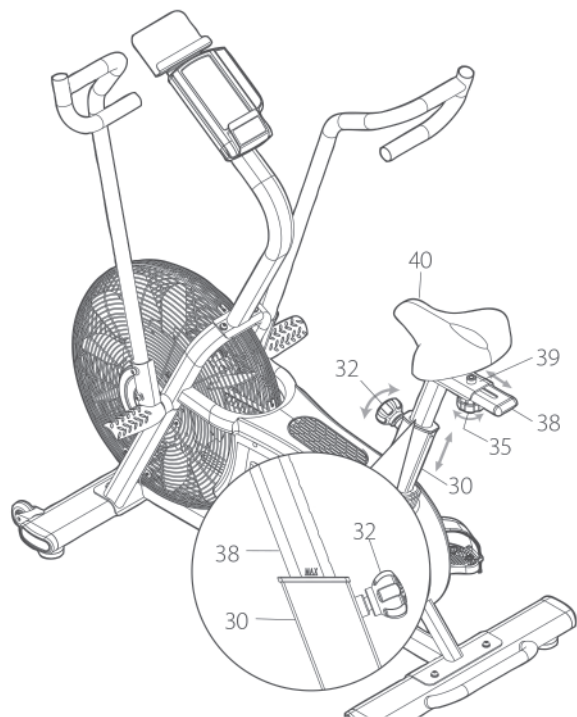

### Correctly Getting On and Off

1. To get on, grip the handles with both hands and first step onto the left pedal with your left foot or onto the right pedal with your right foot and then place your foot onto the other pedal.
2. To get off, grip the handles with both hands and place one foot next to the equipment and then the other foot.

## 3 OPERATING INSTRUCTIONS

### ① NOTICE

- + Familiarise yourself with all the functions and setting options of the device before starting training. Have the proper use of this product explained to you by a specialist.
- + Always start your training with low intensity and increase evenly and gently. End your training with a cool-down phase. If you are unsure, please consult your physician.

### 3.1 Console Display

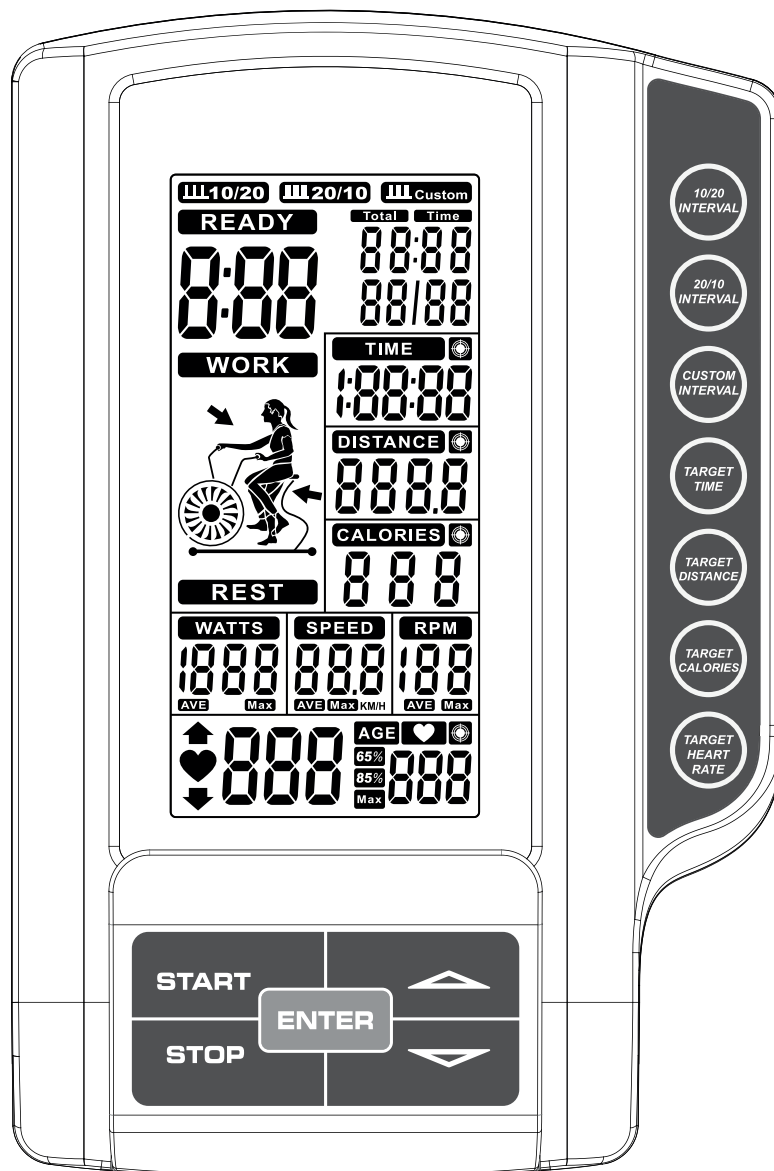

Display	Description
<b>RPM</b>	+ Display of the rotations per minute + Display range: 0–199
<b>SPEED</b>	+ Display of the current speed in km/h or ml/h + Display range: 0–99.9
<b>TIME</b>	+ Display of the training time + Display range: 00:00–1:59:59 + Setting range: 00:01:00–1:59:00 (increments of 1 minute)
<b>DISTANCE</b>	+ Display of the distance in km or ml + Display range: 0.0–999.9 + Setting range: 0.0–999.5 (increments of 0.5 km or ml)
<b>CALROIES</b>	+ Display of the calories in kcal + Display range: 0–999 + Setting range: 0.0–990
<b>WATT</b>	+ Display of Watt + Display range: 0–1999
<b>PULSE</b>	 <b>WARNING</b> Your training equipment is not a medical device. The heart rate measurement of this equipment may be inaccurate. Various factors can affect the accuracy of the heart rate measurement. The heart rate measurement serves only as a training aid.  + Display of the heart rate + Display range: 0–30–230
<b>TOTAL TIME</b>	+ Display of the total training time
<b>READY</b>	+ Display of the start countdown before a new interval
<b>WORK</b>	+ Indicates the working or resting phase during an interval training
<b>REST</b>	

## 3.2 Button Functions

Button	Description
<b>START</b>	+ Start or pause training + Resume training in stop mode
<b>STOP</b>	+ Stop the training + Clear all settings + Hold 2 sec. to reset and restart the console
▼	+ Decrease the setting values
▲	+ Increase the setting values
<b>10/20 INTERVAL</b>	+ Quick access to the interval programmes: + 10/20 + 20/10 + Custom
<b>20/10 INTERVAL</b>	
<b>CUSTOM INTERVAL</b>	
<b>TARGET TIME</b>	+ Quick access to the target programmes: + Time + Distance + Calories + Heart Rate
<b>TARGET DISTANCE</b>	
<b>TARGET CALORIES</b>	
<b>TARGET HEART RATE</b>	
<b>ENTER</b>	+ Confirm settings + Enter the programme



### 3.3 Getting Started

After starting the console, a signal sounds and the display fully lights up (Fig. 1). Then the display shows the wheel diameter (Fig. 2) and enters setting mode for setting the age (Fig 3).

To set the age, press the ▼ or ▲ button and press ENTER to confirm.

The console enters the main menu and the following elements will flash for 1 second each in the sequence of:

INTERVAL10/20 → INTERVAL20/10 → INTERVAL CUSTOM → READY → WORK → REST → TIME → DISTANCE → CALORIE → WATTS → SPEED → RPM → ♥

**NOTICE**

If the console receives no signal (RPM or input) for 30 seconds, the console enters sleep mode.

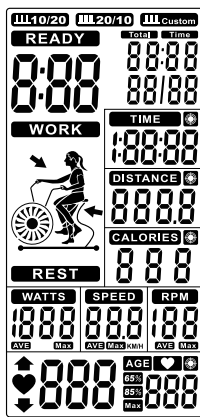

Fig. 1

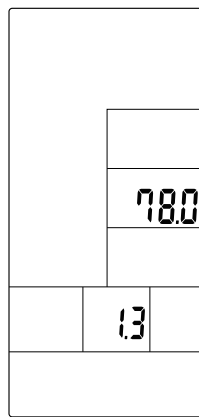

Fig. 2

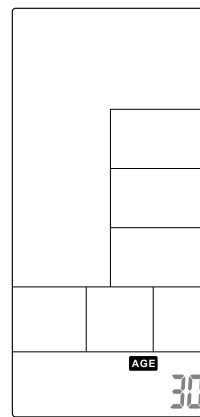

Fig. 3

### 3.4 Sleep Mode

If the console receives no signal (RPM or input) for up to 30 seconds within the main menu or the programme is paused for more than 5 minutes, the console enters sleep mode.

- + To exit the sleep mode within the main menu, press any button or start training.
- + To exit the sleep mode within the paused programme, press START.

## 3.5 Programmes

A total of 8 programmes are available:

- + Quick Start programme: 1
- + Interval programmes: 3 (one of them user-defined)
- + Target programmes: 4 (one of them heart rate controlled)

### 3.5.1 Quick Start Programme

#### **WARNING**

Your training equipment is not a medical device. The heart rate measurement of this equipment may be inaccurate. Various factors can affect the accuracy of the heart rate measurement. The heart rate measurement serves only as a training aid.

#### **NOTICE**

Heart rate measurement is only possible with a compatible chest strap.

1. To start the Quick Start programme press START within the main menu.

*A signal sounds for 1 second and the values for TOTAL TIME, TIME, DISTANCE, CALORIES are counted up. Also the values for WATTS, SPEED, RPM and PULSE are shown (Fig. 4).*

#### **NOTICE**

- + If no pulse signal is received, PULSE shows P (Fig. 4).
- + If the console receives no signal (RPM or input) for 30 seconds, a short signal sounds and the console enters sleep mode.

2. To pause the programme, press START again.

*A signal sounds for 0,5 seconds every 30 seconds and all values are displayed and flashing every 4 seconds.*

3. To resume the programme, press START.
4. To stop the programme, press STOP.

*A signal sounds for 1 second and the values for TOTAL TIME, TIME, DISTANCE, CALORIES, WATTS, SPEED, RPM and PULSE will be shown for 30 seconds.*

#### **NOTICE**

- + The display of the values for WATTS, SPEED, RPM switches every 5 seconds between AVG and MAX.
- + The display of the PULSE switches every 5 seconds between 65%, 85% and MAX.

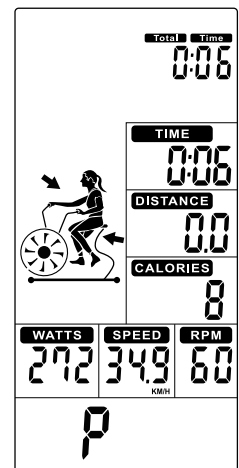

Fig. 4

### 3.5.2 Interval 10/20 and Interval 20/10

Two pre-set interval programmes are available. These programmes are divided into 8 cycles. You can choose between 10/20 or 20/10 (WORK/REST).

**⚠ WARNING**

Your training equipment is not a medical device. The heart rate measurement of this equipment may be inaccurate. Various factors can affect the accuracy of the heart rate measurement. The heart rate measurement serves only as a training aid.

**📌 NOTICE**

Heart rate measurement is only possible with a compatible chest strap.

1. To start an pre-set interval training, press the respective button and press ENTER to confirm.

*The interval icon of the chosen interval is shown in the display and a signal sounds for 1 second.*

*A countdown counts from 3 to 0 and READY flashes once per second. The WORK sequence starts afterwards (Fig. 5 & 6).*

*The values for TOTAL TIME, TIME, DISTANCE, CALORIES are counted up. Also the values for WATTS, SPEED, RPM and PULSE are shown (Fig. 6–8).*

**📌 NOTICE**

- + If no pulse signal is received, PULSE shows P.
- + If the console receives no signal (RPM or input) for 30 seconds, a short signal sounds and the console enters sleep mode.

*During the WORK sequence WORK flashes once per second. After the WORK sequence the REST sequence starts. The display shows REST and REST flashes and a signal sounds once per second (Fig. 6 & 7).*

*The finished cycles are shown within the display below TOTAL TIME.*

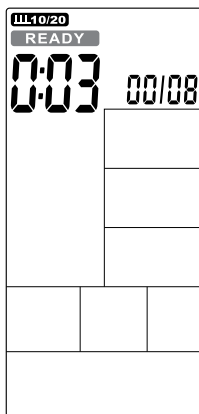

Fig. 5

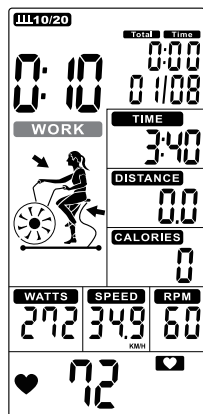

Fig. 6

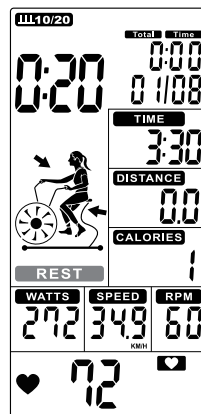

Fig. 7

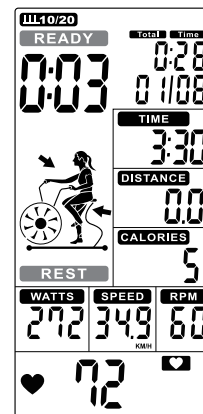

Fig. 8

2. To pause the programme, press START.
3. To resume the programme, press START again.
4. To end the programme, press STOP or finish the interval training.

A signal sounds for 1 second and the values for TOTAL TIME, TIME, DISTANCE, CALORIES, WATTS, SPEED, RPM and PULSE will be shown for 30 seconds.

**NOTICE**

- + The display of the values for WATTS, SPEED, RPM switches every 5 seconds between AVG and MAX.
- + The display of the PULSE switches every 5 seconds between 65%, 85% and MAX.

### 3.5.3 Interval Custom

**WARNING**

Your training equipment is not a medical device. The heart rate measurement of this equipment may be inaccurate. Various factors can affect the accuracy of the heart rate measurement. The heart rate measurement serves only as a training aid.

**NOTICE**

Heart rate measurement is only possible with a compatible chest strap.

1. To enter the custom interval programme press the respective button and press ENTER to confirm.

The interval icon of the chosen interval is shown in the display and a signal sounds for 1 second (Fig 9).

2. To set the number of cycles (1–99), press ▼ or ▲ and press ENTER to confirm.

A signal sounds and the console changes to the WORK time setting option (Fig. 10).

**NOTICE**

The time can be set from 0:01–9:59.

3. To set the time for the WORK sequence, press ▼ or ▲ and press ENTER to confirm.

A signal sounds and the console changes to the REST time setting option (Fig. 11).

4. To set the time for the REST sequence, press ▼ or ▲ and press ENTER to confirm.

A countdown counts from 3 to 0 and READY flashes once per second and the WORK sequence starts afterwards (Fig. 12).

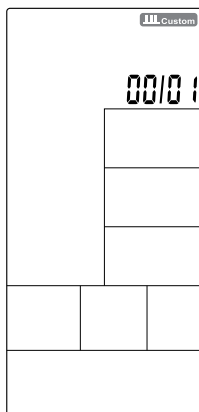

Fig. 9

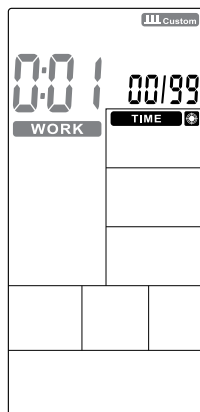

Fig. 10

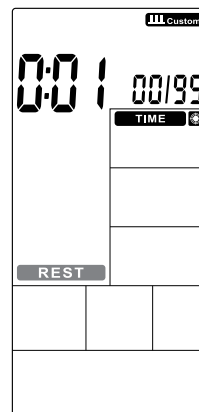

Fig. 11

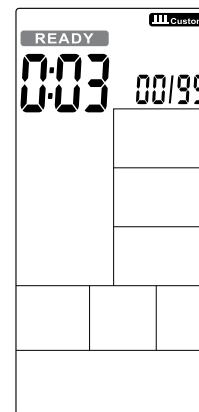

Fig. 12

The values for TOTAL TIME, TIME, DISTANCE, CALORIES are counted up. Also the values for WATTS, SPEED, RPM and PULSE are shown (Fig. 13–15).

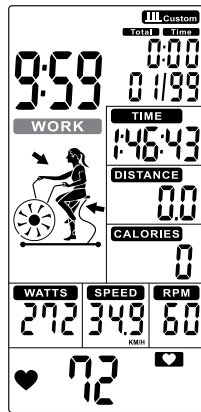

Fig. 13

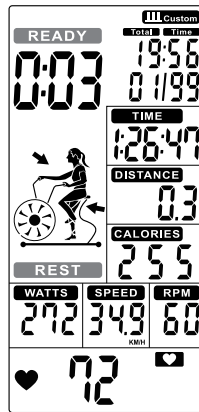

Fig. 14

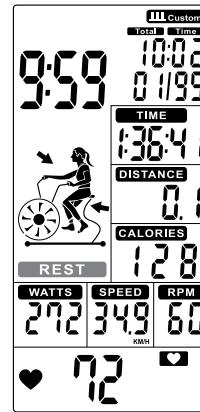

Fig. 15

**NOTICE**

- + If no pulse signal is received, PULSE shows P.
- + If the console receives no signal (RPM or input) for 30 seconds, a short signal sounds and the console enters sleep mode.

During the WORK sequence WORK flashes once per second. After the WORK sequence the REST sequence starts. The display shows REST and REST flashes and a signal sounds once per second (Fig. 13–15).

The finished cycles are shown in the display below TOTAL TIME (Fig. 13–15).

1. To pause the programme, press START.
2. To resume the programme, press START again.
3. To end the programme, press STOP or finish the interval training.

A signal sounds for 1 second and the values for TOTAL TIME, TIME, DISTANCE, CALORIES, WATTS, SPEED, RPM and PULSE will be shown for 30 seconds.

**NOTICE**

- + The display of the values for WATTS, SPEED, RPM switches every 5 seconds between AVG and MAX.
- + The display of the PULSE switches every 5 seconds between 65%, 85% and MAX.

### 3.5.4 Target Time, Target Distance and Target Calories

1. To enter one of the target programmes, press the respective button.

The icon of the chosen programme is shown in the display, a signal sounds for 1 second and the value to be set flashes (Fig. 16–18).

2. To set the target value, press the ▼ or ▲ button and press ENTER to confirm.

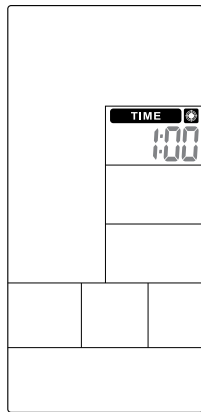

Fig. 16

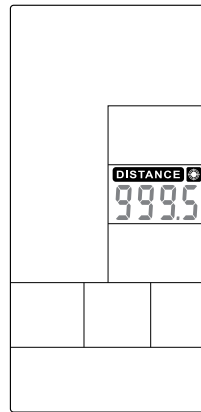

Fig. 17

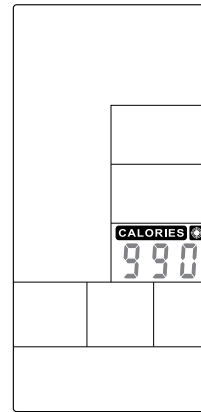

Fig. 18

A signal sounds and the programme starts.

The set value counts down and the remaining values are counted up.

#### ① NOTICE

- + If no pulse signal is received, PULSE shows P.
- + If the console receives no signal (RPM or input) for 30 seconds, a short signal sounds and the console enters sleep mode.

3. To pause the programme, press START.
4. To resume the programme, press START again.
5. To end the programme, press STOP or finish the target.

A signal sounds for 1 second and the values for TOTAL TIME, TIME, DISTANCE, CALORIES, WATTS, SPEED, RPM and PULSE will be shown for 30 seconds.

#### ① NOTICE

- + The display of the values for WATTS, SPEED, RPM switches every 5 seconds between AVG and MAX.
- + The display of the PULSE switches every 5 seconds between 65%, 85% and MAX.

### 3.5.5 Target HR

#### **⚠ WARNING**

Your training equipment is not a medical device. The heart rate measurement of this equipment may be inaccurate. Various factors can affect the accuracy of the heart rate measurement. The heart rate measurement serves only as a training aid.

#### **ℹ NOTICE**

Heart rate measurement is only possible with a compatible chest strap.

1. To enter the target HR programme, press the respective button.

*The icon of the target HR programme is shown in the display and a signal sounds for 1 second.*

*The value for the age is flashing.*

2. To set the age, press the ▼ or ▲ button and press ENTER to confirm.

*A signal sounds and the programme starts.*

*Within the display of the PULSE, MAX, 65% and 85% will be shown (Fig. 19 & 20).*

*The values for TOTAL TIME, TIME, DISTANCE, CALORIES are counted up. Also the values for WATTS, SPEED, RPM and PULSE are shown (Fig. 19–21).*

#### **ℹ NOTICE**

- + If no pulse signal is received, PULSE shows P.
- + If the console receives no signal (RPM or input) for 30 seconds, a short signal sounds and the console enters sleep mode.

*The console indicates whether the heart rate is below 65% or above 85%. The respective icons will be shown and a signal will sound every 10 seconds until the heart rate is within the ideal area (Fig. 19–21).*

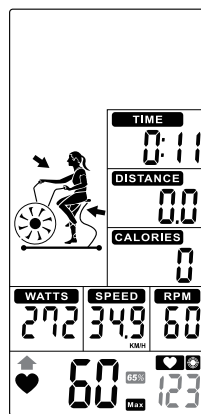

Fig. 19

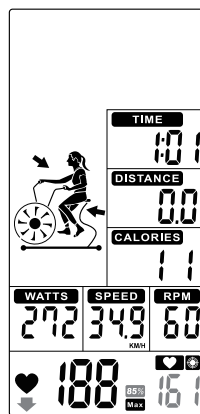

Fig. 20

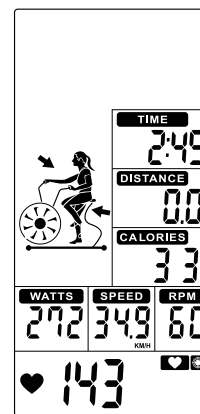

Fig. 21

3. To pause the programme, press START.
4. To resume the programme, press START again.
5. To end the programme, press STOP.

*A signal sounds for 1 second and the values for TOTAL TIME, TIME, DISTANCE, CALORIES, WATTS, SPEED, RPM and PULSE will be shown for 30 seconds.*

**① NOTICE**

- + The display of the values for WATTS, SPEED, RPM switches every 5 seconds between AVG and MAX.
- + The display of the PULSE switches every 5 seconds between 65%, 85% and MAX.

### **3.6 Changing the Units**

1. To change the units, press and hold START and ENTER for 2 seconds.

*A signal sounds, SPEED keeps lighting up and ml/h and km/h flash once per second.*

2. To select one of the units, press ▼ or ▲ and press ENTER to confirm.



## 3.7 Workout tips

When training, it is important to perform the exercises correctly in order to avoid injuries and achieve the desired training effect. Make sure you use the correct technique and train at an appropriate intensity level. Always consult an expert such as a trainer or doctor if you are unsure or have health problems. Always start your training with a low load and increase it evenly and gently.

End your training with a cool-down phase. If you have any questions or uncertainties, contact your doctor.

### 3.7.1 Training clothes

During training, wear appropriate sports clothing that is comfortable and breathable. Avoid clothing that restricts you or is uncomfortable. Make sure that your shoes are suitable and offer you sufficient support. In addition, always carry a towel with you to wipe away sweat and keep the equipment clean.

### 3.7.2 Warming up and stretching

It is important to warm up and stretch properly before training to avoid injury and improve performance. Stretching helps to loosen muscles and improve flexibility. Be sure to incorporate a short stretching routine before each workout.

#### Warm-up exercise:

1. Stand upright with your feet about shoulder-width apart.
2. Start with gentle arm circles by slowly moving your arms forwards in small circles in a controlled manner.
3. Perform arm circles backwards to loosen your shoulders and arms.
4. Do squats by slowly squatting down and then straightening up again. Make sure that your knees do not extend beyond your toes.



#### **CAUTION**

Do not exercise with sore muscles or take it easy on the affected muscles, as this can lead to injuries.

### 3.7.3 Medication

If you regularly take medication and want to exercise, it is important to be aware of possible side effects. Ask your doctor whether your medication affects your workout.

### 3.7.4 Used muscle groups

Cycling uses the following muscle groups:

- + Gluteal muscle
- + Leg muscles

Make sure you keep your back straight during training. Do not hunch over and do not arch your back. Do not fully extend your legs, but keep a slight bend in the backwards movement.

### 3.7.5 Exercise frequency

Regular exercise is crucial to making progress and staying healthy in the long term. Continuous exercise can strengthen muscles, improve endurance and enhance overall well-being. Remember that even small workouts can be done regularly to achieve long-term results.

#### **Training with heart rate orientation**

Heart rate orientation guarantees an extremely effective and healthy training. Through your age and the following table, you can quickly and easily read and determine the optimal pulse for your training. An acoustic alarm will sound if your heart rate exceeds the set target heart rate. Which target heart rate is important for which training goal can be found out in the following.

**Fat burning (weight management):** The main goal here is to burn deposits of fat. In order to achieve this training goal, a low training intensity (approximately 55% of the maximum heart rate) and a longer training period are required.

**Cardiovascular training (cardio training):** The primary goal is to increase stamina and fitness through an improved provision of oxygen through the cardiovascular system. In order to achieve this training goal, medium intensity (approximately 75% of the maximum heart rate) with a medium training period is required.

**Anaerobic (maximum) load training:** The main goal of maximum load training is to improve recovery after short, intense loads in order to be able to quickly return to the aerobic zone. In order to achieve this training goal, a high intensity (approximately 90% of the maximum heart rate) with short, intense load is required, which is followed by a recovery phase in order to prevent muscle fatigue.

**Example:**

For a 45-year-old man or woman, the maximum heart rate is 175 ( $220 - 45 = 175$ ).

- + The fat burning target zone (55%) is at approximately 96 beats/min. =  $(220 - \text{age}) \times 0.55$ .
- + The cardio target zone (75%) is at approximately 131 beats/min. =  $(220 - \text{age}) \times 0.75$ .
- + The maximum heart rate for an anaerobic load training (90%) is at approximately 157 beats/min. =  $(220 - \text{age}) \times 0.9$ .

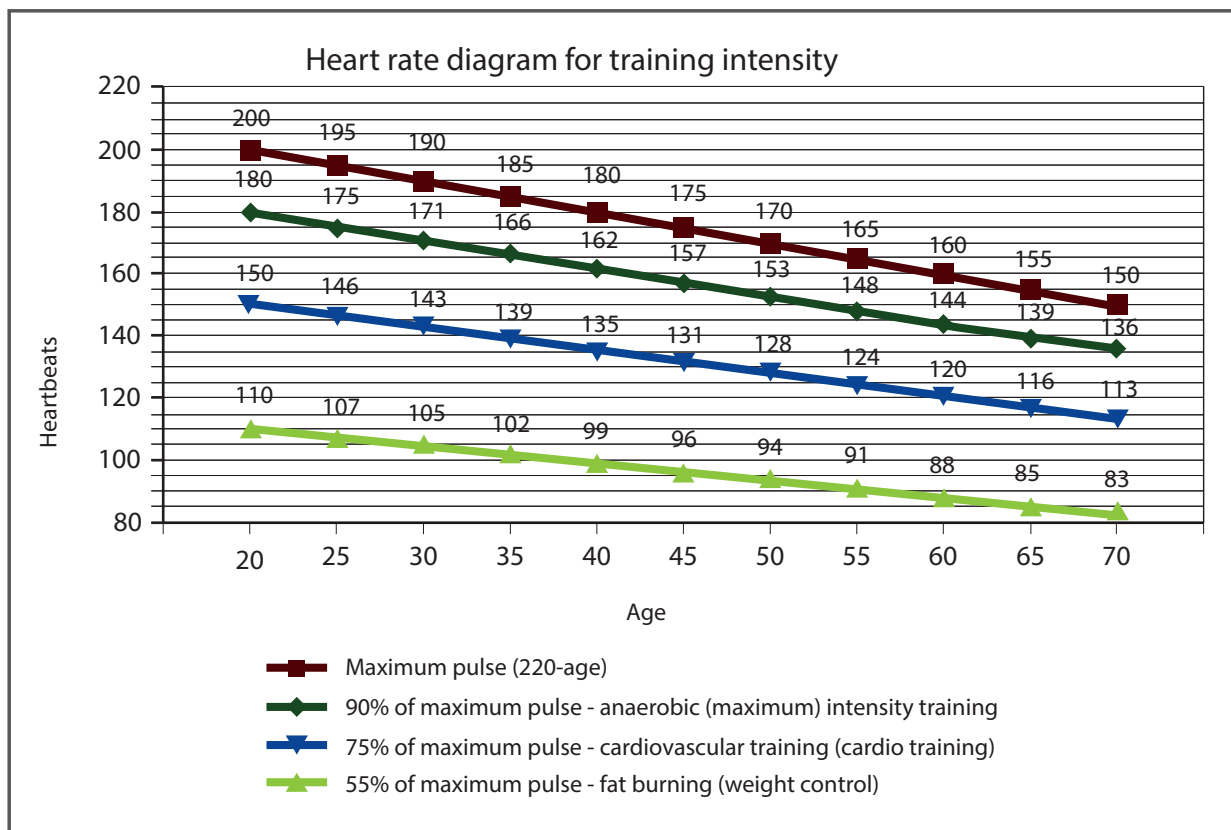

### 3.8 Workout journal



(Copy template)

Date	Distance	Time (min.)	Resistance level	Training weight	Ø Pulse	Calories burnt	I feel ...	Body weight

## 4.1 General Instructions

### WARNING

- + The storage location should be chosen so that improper use by third parties or children can be prevented.
- + If your equipment does not have transportation wheels, the equipment must be disassembled before transportation.

### ATTENTION

- + Make sure that the equipment is protected from moisture, dust and dirt in the selected storage location. The storage location should be dry and well ventilated and have a constant ambient temperature between 10°C and 35°C.

## 4.2 Transportation Wheels

### ATTENTION

If you want to transport your equipment over particularly sensitive and soft floor coverings, such as parquet, planks or laminate, lay out the transport route with cardboard or similar to avoid possible floor damage.

1. Stand behind the equipment and lift it until the weight is transferred to the transportation wheels. After that, you easily can move the equipment to a new position. For long transport distances the equipment should be disassembled and safely packed.
2. Select the new location by following the instructions in the section 1.4 of this manual.

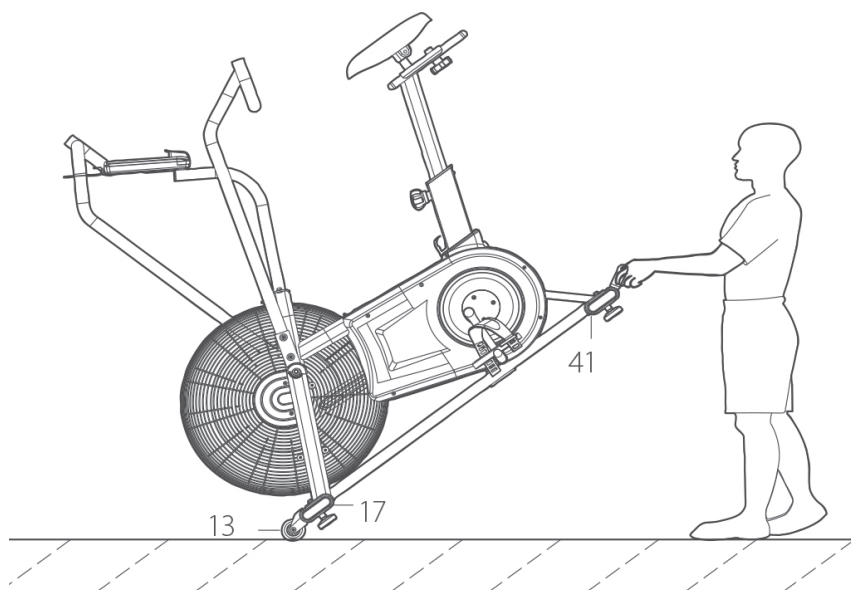

## 5.1 General Instructions



### WARNING

- + Do not make any improper changes to the equipment.



### CAUTION

- + Damaged or worn components may affect your safety and the life of the equipment. Therefore, immediately replace damaged or worn components. In such a case, contact the contract partner. The equipment must not be used until it has been repaired. If necessary, use only original spare parts.

### ► ATTENTION

- + In addition to the instructions and recommendations for maintenance and care given here, additional service and/or repair work may be necessary; this must only be carried out by authorised service technicians.

## 5.2 Faults and Fault Diagnosis

The equipment undergoes regular quality controls during production. Nevertheless, faults or malfunctions may occur. Frequently, individual parts are responsible for these disturbances, an exchange is usually sufficient. Please refer to the following overview for the most common errors and how to correct them. If the equipment still does not function properly, contact your contract partner.

Fault	Cause	Solution
Cracking in the pedal area	Pedals loose	Tighten the pedals
Equipment wobbles	Equipment is not level	Align the feet
Handlebar/saddle wobbles	Loose screws	Tighten screws firmly
Display is blank/is not working	Batteries empty or loose cable connection	Replace batteries or check cable connections
No pulse display	<ul style="list-style-type: none"> <li>+ Sources of interference in the room</li> <li>+ unsuitable chest strap</li> <li>+ Wrong position of chest strap</li> <li>+ Chest strap defective or battery empty</li> <li>+ Pulse display defective</li> </ul>	<ul style="list-style-type: none"> <li>+ Eliminate sources of interference (e.g. mobile phone, WLAN, lawn mower and vacuum cleaner robot, etc. ...)</li> <li>+ Use a suitable chest strap (see RECOMMENDED ACCESSORIES)</li> <li>+ Reposition chest strap and/or moisten electrodes</li> <li>+ Changing batteries</li> <li>+ Check if pulse display by hand pulse possible</li> </ul>

### 5.3 Error Codes and Troubleshooting

The electronics of the equipment continuously carries out tests. In case of deviations, an error code appears on the display and normal operation is stopped for your safety.

**Please contact the contract partner for technical support.**

### 5.4 Maintenance and Inspection Calendar

To avoid damage from body sweat, the equipment must be cleaned with a damp towel (no solvents!) after each training session.

The following routine tasks must be performed at the specified intervals:

Part	Weekly	Monthly
Display console	C	I
Plastic covers	C	I
Screws and cable connections		I
Check pedals for tightness		I
Legend: C = clean; I = inspect		

By scanning the QR code with the camera function or QR code scanner app of your smartphone/tablet, a video on general maintenance of an exercise bike opens on YouTube. The video serves to illustrate the maintenance points described in this manual.



Please note that the video may not be available in your language or with appropriate subtitles.

If you cannot scan QR codes, you can access all Fitshop videos on YouTube by first opening YouTube and entering "Fitshop" in the search field.

## 6 DISPOSAL

At the end of its operational life, this equipment cannot be disposed of in normal household waste. Instead, it must be disposed of via an electricals recycling centre. Further information can be obtained from your local authority's recycling service.

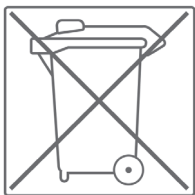

The materials can be recycled as per their symbols. Through the reuse, recycling of materials or other forms of recovery of old equipment, you make an important contribution to the protection of the environment.

## 7 RECOMMENDED ACCESSORIES

To make your training experience even more efficient and pleasant, we recommend that you add suiting accessories to your fitness equipment. For exercise bikes this could for example be a **floor mat**, which makes your fitness equipment stand more securely and also protects the floor from sweat or **silicone spray** to keep moving parts in good shape. For many exercise bikes it is possible to replace the **saddle** or **pedals**, as these are usually the same mounts used on bicycles.

If you have purchased a fitness machine with pulse training and want to train your heart rate, we strongly recommend that you use a compatible **chest strap**, as this ensures optimum transmission of the heart rate.

Our range of accessories offers the highest quality and makes training even better. If you would like to find out more about compatible accessories, please go to the detail page of the product in our webshop (the easiest way is to enter the article number in the search field above) and go to the recommended accessories on this page. Of course, you can also contact our customer service: by telephone, e-mail, in one of our branches or via our social media channels. We will be happy to advise you!



chest strap



floor mat



lubricant



## 8.1 Serial Number and Model Name

In order to provide you with the best possible service, please have the model name, article number, serial number, exploded drawing and parts list ready. The corresponding contact options can be found in chapter 10 of this operating manual.

**NOTICE**

The serial number of your equipment is unique. It's located on a white sticker. The exact position of this sticker is shown in the following illustration.

Enter the serial number in the appropriate field.

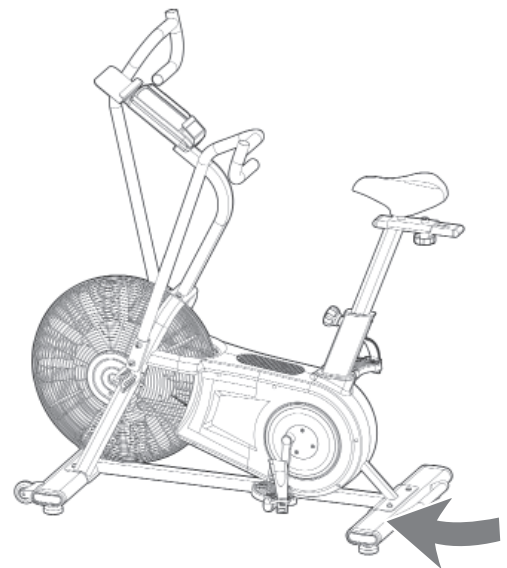

**Serial number:**

**Brand / Category:**

**Model Name:**

**SKU:**

## 8.2 Parts List

No.	Name	Qty.
1	Computer	1
2	Bolt (M4×16)	4
3	End Cap	1
4	Trunk Wire	1
5	Computer Post	1
6	Bolt (M5×13×Φ8)	6
7	Washer (D8×Φ16×1.5)	8
8	Bolt (M8×20×S5)	10
9	Spring Washer (D8)	11
10	Arc Washer (D8×Φ20×2×R32)	4
11	Bolt (M8×42×15×S5)	2
12	iPAD Holder	1
13	Transportation Wheel (φ71×24)	2
14	Wave Washer (D10×Φ15×0.3)	1
15	Grommet (Φ12.5)	1
16	End Cap with EVA plate	4
17	Front Stabilizer	1
18	N/A	
19	Magnet (φ15×7)	1
20	Nut (M8×H5.5×S14)	4
21	Adjustable Footpad	4
22	N/A	
23L/R	Pedal Plate	1
24	Crank Cover	4
25	Nut (M10×1.25×H7.5×S14)	4
26	Swing Bar	2
27L/R	Handlebar	1
28	Plastic Pedal	1
29	Belt	1
30	Main Frame	1
31L/R	Pedal	1

32	Knob (M16×1.5×27×Φ56)	1
33	Screw (ST4.2×10×Φ8)	1
34	Bushing	1
35	Knob (M12×37×15×Φ58)	1
36	Washer (D12×Φ24×2)	1
37	End Cap (PT60×20×30)	2
38	Saddle Tube	1
39	Saddle Fixed Plate	1
40	Saddle	1
41	Rear Stabilizer	1
42	Bolt (ST4.2×13×Φ8)	14
43	Axle	1
44	Bolt (M6×16×S5)	4
45	Front Net-caps	1
46	Rear Net-caps	1
47	Nut(M6×H6×S10)	2
48	U Seat	2
49	Nut (M10×1×H8×S15)	2
50	Chain Bolt	2
51	Nut (M10×1×H5×S17)	2
52	Spacer (φ10.1×φ15×9)	2
53	Bearing (6000-2RS)	2
54	Nylon Nut (M6×H6×S10)	8
55	Spring Washer (D6)	8
56	Fan Wheel	1
57	Shaft	1
58	Sleeve	1
59	Bolt (M6×16×S10)	4
60	Bolt (ST4.2×19×Φ8)	17
61	Sensor Seat	1
62	Sensor	1
63	Bolt (M4×10×Φ8)	2
64	Washer (D4×Φ18×1.5)	10
65	Front Cover	2

66	C-clip	3
67	Bearing (6804-2RS)	4
68	Wave Washer (D20×Φ26×0.3)	5
69	Connector	2
70	Bushing (φ28×6.2)	2
71	Rod	2
72	Washer (D8×Φ32×2)	2
73	Nylon Nut (M8×H7.5×S13)	4
74L/R	Chain Cover	1
75L/R	Crank	1
76	Turntable	2
77	C-clip	2
78	Bearing (6203-2RS)	2
79	Spring (D40)	2
80	Bolt (M6×16×S10)	1
81	Washer (D6×Φ20×2)	1
82	Small Crank	1
83	Bolt (M8×40×S6)	1
84	Bearing (6004-2RS)	2
85	Spacer (Φ25×Φ20.1×4)	1
86	Belt Plate	1
A	Allen Wrench (S5)	1
B	Spanner (S13/14/15)	1

# 8.3 Exploded Drawing

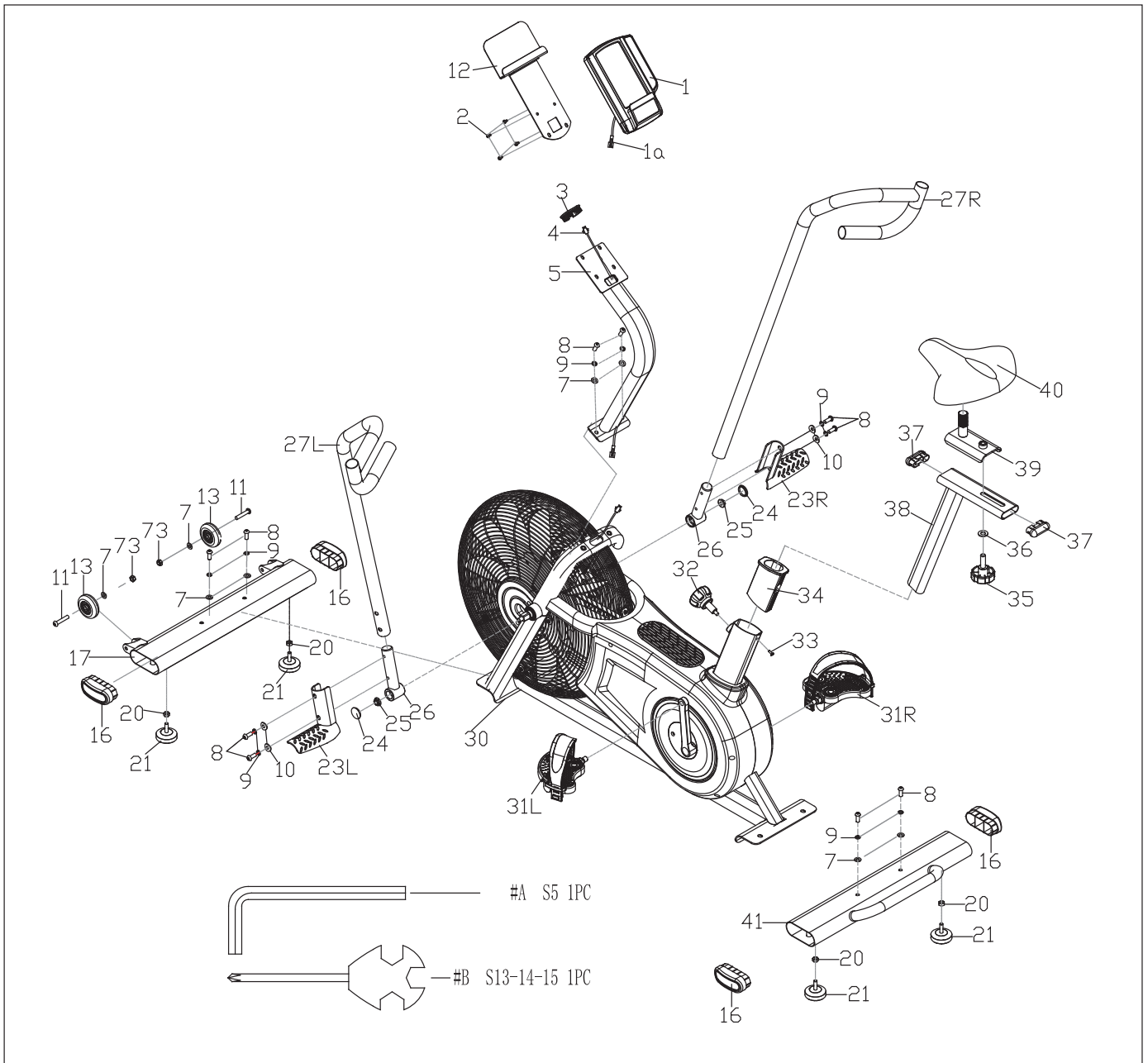

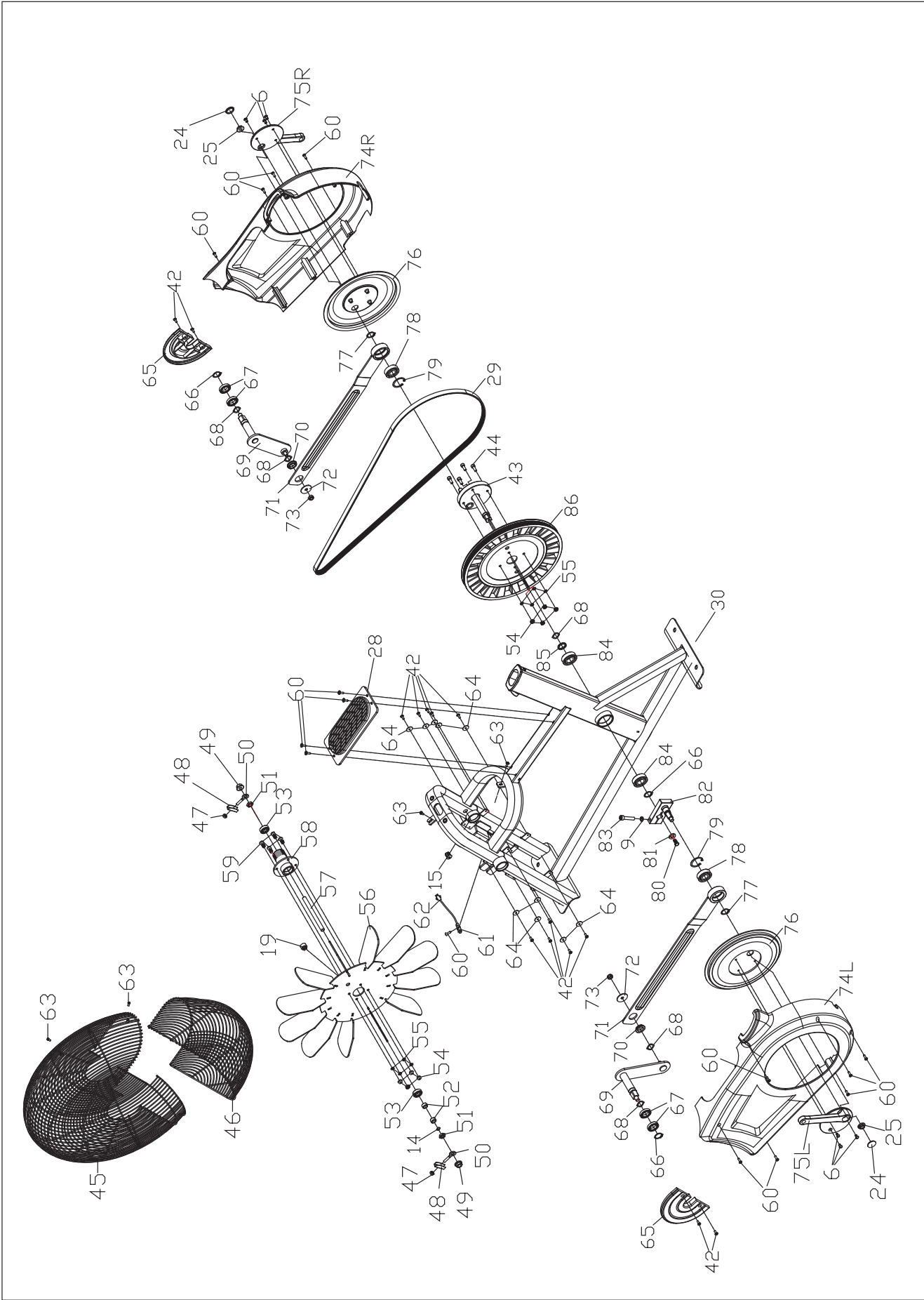

Products from TAURUS® are subject to strict quality control. However, if a fitness equipment purchased from us does not work perfectly, we take it very seriously and ask you to contact our customer service as indicated. We are happy to help you by phone via our service hotline.

### **Error Descriptions**

Your fitness equipment is developed for long-term, high-quality training. However, should a problem arise, please first read the operating instructions. For further assistance, please contact your contract partner or call our service hotline. To ensure your problem is solved as quickly as possible, please describe the defect as exactly as possible.

In addition to the statutory warranty, we provide a warranty for every fitness equipment purchased from us according to the following provisions.

**Your statutory rights are not affected.**

### **Warranty**

The warranty is the first/original buyer.

### **Warranty periods**

The following warranty periods begin on delivery of the fitness equipment.

#### **Warranty period**

The warranty periods, shown on our web shop, begin on delivery of the fitness equipment. The respective warranty periods for your equipment can be found on its product website.

### **Repair Costs**

According to our choice, there will either be a repair, a replacement of individual damaged parts or a complete replacement. Spare parts, that have to be mounted while assembling the equipment, have to be replaced by the warranty holder personally and are not a part of repair. After the expiration of the warranty period, the responsibility for parts costs, repair costs, installation costs and delivery costs lies with the warranty holder.

### **The terms of use are defined as follows:**

- + Home use: solely for private use in private households up to 3 hours per day
- + Semi-professional use: up to 6 hours per day (e. g. rehabilitation centres, hotels, clubs, company gyms)
- + Professional use: more than 6 hours per day (e. g. commercial gyms)

## **Warranty Service**

Within the warranty period, equipment which develops faults as a result of material or manufacturing defects, will be repaired or replaced at our discretion. Ownership of equipment or parts of equipment which have been replaced is transferred to us. The warranty period is not extended nor does a new warranty period begin following repair or replacement under the warranty.

## **Warranty Conditions**

For the warranty to be valid, the following steps must be taken:

Please contact our customer service by email or phone. If the product under warranty has to be sent in for repair, the seller bears costs. After expiry of the warranty, the buyer bears the costs of transport and insurance. If the fault is covered by our warranty, you will receive a new or repaired equipment in return.

## **Warranty claims are invalid in case of damage resulting from:**

- + misuse or improper handling
- + environmental influences (moisture, heat, electrical surge, dust, etc.)
- + failure to follow the current safety measures for the equipment
- + failure to follow the operating instructions
- + use of force (e. g. hitting, kicking, falling)
- + interventions which were not carried out by one of our authorized service centres
- + unauthorised repair attempts

## **Proof of Purchase and Serial Number**

Please make sure that you are able to provide the appropriate receipt when claiming on your warranty. So that we can clearly identify the model of your equipment, and for the purposes of our quality control, you will need to give the serial number of your equipment, when contacting the service team. Where possible please have your serial number and your customer number ready when you call our service hotline. It will help us to deal with your request swiftly.

If you cannot find the serial number on your fitness equipment, our service team is at your disposal to offer further information.

## **Service outside of the Warranty Period**







































We are also happy to issue an individual cost estimate if there is a problem with your fitness equipment after the warranty has expired, or in cases which do not fall under the terms of the warranty, e. g. normal wear and tear. Please contact our customer service team to find a quick and cost-effective solution to your problem. In such a case you will be responsible for the delivery costs.

## **Communication**

Many problems can be solved just by speaking to us as your specialist supplier. We know how important it is to you as a user of the fitness equipment to have problems solved quickly and simply, so you can enjoy working out with minimal interruption. For that reason, we also want to resolve your queries quickly and in a straightforward manner. Thus, please always keep your customer number and the serial number of the faulty equipment handy.



## 10 CONTACT

DE	DK	UK
<p><b>TECHNIK</b></p> <p> +49 4621 4210-900</p> <p> +49 4621 4210-698</p> <p> technik@fitshop.de</p> <p> Öffnungszeiten entnehmen Sie unserer Homepage.</p> <p><b>SERVICE</b></p> <p> 0800 20 20277 (kostenlos)</p> <p> 04621 4210 - 0</p> <p> info@fitshop.de</p> <p> Öffnungszeiten entnehmen Sie unserer Homepage: <a href="https://stg.fit/statita">https://stg.fit/statita</a></p>	<p><b>TEKNIK OG SERVICE</b></p> <p> 80 90 16 50</p> <p>+49 4621 4210-945</p> <p> info@fitshop.dk</p> <p> Åbningstider kan findes på hjemmesiden: <a href="https://stg.fit/statit7">https://stg.fit/statit7</a></p> <p><b>FR</b></p> <p><b>TECHNIQUE &amp; SERVICE</b></p> <p> +33 (0) 189 530984</p> <p>+49 4621 42 10 933</p> <p> info@fitshop.fr</p> <p> Vous trouverez les heures d'ouverture sur notre site Internet: <a href="https://stg.fit/statit4">https://stg.fit/statit4</a></p>	<p><b>CUSTOMER CARE</b></p> <p> +44 141 737 2249 or +44 141 876 3972</p> <p> customercare@fitshop.co.uk</p> <p> You can find the opening hours on our homepage: <a href="https://stg.fit/statitd">https://stg.fit/statitd</a></p> <p><b>BE</b></p> <p><b>TECHNIQUE &amp; SERVICE</b></p> <p> 02 732 46 77</p> <p>+49 4621 4210 933</p> <p> info@fitshop.be</p> <p> Vous trouverez les heures d'ouverture sur notre site Internet: <a href="https://stg.fit/statit8">https://stg.fit/statit8</a></p>
ES	NL	INT
<p><b>TECNOLOGÍA Y SERVICIOS</b></p> <p> 911 238 029</p> <p> info@fitshop.es</p> <p> Consulta nuestro horario de apertura en la página web: <a href="https://stg.fit/statit5">https://stg.fit/statit5</a></p>	<p><b>TECHNISCHE DIENST &amp; SERVICE</b></p> <p> +31 172 619961</p> <p> service@fitshop.nl</p> <p> De openingstijden vindt u op onze homepage: <a href="https://stg.fit/statit3">https://stg.fit/statit3</a></p>	<p><b>TECHNICAL SUPPORT &amp; SERVICE</b></p> <p> +49 4621 4210-944</p> <p> service-int@fitshop.de</p> <p> You can find the opening hours on our homepage: <a href="https://stg.fit/statita">https://stg.fit/statita</a></p>
PL	AT	CH
<p><b>DZIAŁ TECHNICZNY I SERWIS</b></p> <p> 22 307 43 21</p> <p>+49 4621 42 10-948</p> <p> info@fitshop.pl</p> <p> Godziny otwarcia można znaleźć na stronie głównej: <a href="https://stg.fit/statit6">https://stg.fit/statit6</a></p>	<p><b>TECHNIK &amp; SERVICE</b></p> <p> 0800 20 20277 (Freecall)</p> <p>+49 4621 42 10-0</p> <p> info@fitshop.at</p> <p> Öffnungszeiten entnehmen Sie unserer Homepage: <a href="https://stg.fit/statitb">https://stg.fit/statitb</a></p>	<p><b>TECHNIK &amp; SERVICE</b></p> <p> 0800 202 027</p> <p>+49 4621 42 10-0</p> <p> info@fitshop.ch</p> <p> Öffnungszeiten entnehmen Sie unserer Homepage: <a href="https://stg.fit/statit9">https://stg.fit/statit9</a></p>

Please find a detailed overview including address and opening hours for all stores of Fitshop UK on the following website:

[www.fitshop.co.uk/storelocator](http://www.fitshop.co.uk/storelocator)

# WE LIVE FITNESS

## WEBSHOP AND SOCIAL MEDIA

The Fitshop Group is Europe's largest specialist for home fitness equipment with currently 70 stores and one of the world's most renowned online mail order companies for fitness equipment.

Fitshop UK is part of the Fitshop Group. Private customers order via the 25 web shops in the respective national language or have their desired equipment assembled on site. In addition, the company supplies fitness studios, hotels, sports clubs, companies and physio practices with professional equipment for endurance and strength training.

The Fitshop group offers a wide range of fitness equipment from renowned manufacturers, high-quality in-house developments and comprehensive services, such as a build-up service and sports scientific advice before and after the purchase. The company employs numerous sports scientists, fitness trainers and competitive athletes.

Visit us also on our social media platforms or our blog!



<https://www.fitshop.co.uk/>  
[www.fitshop.co.uk/blog/](https://www.fitshop.co.uk/blog/)



[www.facebook.com/fitshop.co.uk](https://www.facebook.com/fitshop.co.uk)



[www.instagram.com/fitshop\\_uk](https://www.instagram.com/fitshop_uk)



[www.youtube.com/@fitshop\\_uk](https://www.youtube.com/@fitshop_uk)

**TAURUS**

 cardiostrong

*BODYCRAFT*

**BodyMax**



**TAURUS®**