

TAURUS®

Assembly and Operating Instructions



max. 180 kg



~ 60 Min.



95 kg

L 232 | W 95 | H 172

CVET2514.01.03

SKU: CVET2514

Crosstrainer X9.9

Content

1	GENERAL INFORMATION	7
1.1	Technical Data	7
1.2	Personal Safety	8
1.3	Electrical Safety	9
1.4	Set-Up Place	9
2	ASSEMBLY	10
2.1	General Instructions	10
2.2	Scope of Delivery	11
2.3	Assembly	12
3	OPERATING INSTRUCTIONS	19
3.1	Console display	19
3.2	Button functions	20
3.3	Powering on the crosstrainer	21
3.4	Standby mode	21
3.5	MANUAL (Manual programmes)	22
3.5.1	Quick-Start programme	22
3.5.2	Target programmes	22
3.6	PROGRAM (Profile programmes)	23
3.7	USER (User defined programme)	25
3.8	H.R.C. (Heart rate controlled programmes)	26
3.9	WATT (Watt programme)	27
3.10	RECOVERY (Recovery function)	27
3.11	BODY FAT (Body fat analysis)	28
3.12	Bluetooth and fitness apps	29
4	STORAGE AND TRANSPORT	30
4.1	General Instructions	30
4.2	Transportation Wheels	30
5	TROUBLESHOOTING, CARE AND MAINTENANCE	31
5.1	General Instructions	31
5.2	Faults and Fault Diagnosis	31
5.3	Error codes and troubleshooting	32
5.4	Maintenance and Inspection Calendar	33
6	DISPOSAL	33

7	RECOMMENDED ACCESSORIES	34
8	ORDERING SPARE PARTS	35
8.1	Serial Number and Model Name	35
8.2	Parts List	36
8.3	Exploded Drawing	40
9	WARRANTY	41
10	CONTACT	43

Dear customer,

Thank you for choosing a high-quality equipment of the brand Taurus®. Taurus® offers sports and fitness equipment for the sophisticated home sport and the equipment of fitness studios and business customers. With Taurus® fitness equipment, the focus is on what sport is all about: maximum performance! Therefore, the equipment is developed in close consultation with athletes and sports scientists. Because athletes know best what makes perfect fitness equipment.

Further information can be found at www.sport-tiedje.com.

Intended Use

The equipment may only be used for its intended purpose.

The equipment is suitable for home use and semi-professional use (e.g. hospitals, clubs, hotels, schools, etc.). The equipment is not suitable for commercial or professional use (e.g. fitness studio).

Legal Notice

Sport-Tiedje GmbH
Europe's No. 1 for home fitness

International Headquarters
Flensburger Straße 55
24837 Schleswig
Germany

Management:
Christian Grau
Sebastian Campmann
Dr. Bernhard Schenkel
No. HRB 1000 SL
Local Court Flensburg
European VAT Number: DE813211547

Disclaimer



©2010 Taurus® is a registered brand of the company SportTiedje GmbH. All rights reserved. Any use of this trademark without the explicit written permission of Sport-Tiedje is prohibited.

Product and manual are subject to change. Technical data can be changed without advance notice.

ABOUT THIS MANUAL

Please carefully read the entire manual before installation and first use. The manual will help you to quickly set up the system and explains how to safely use it. Make sure that all persons exercising with the equipment (especially children and persons with physical, sensory, mental or motor disabilities) are informed about this manual and its contents in advance. In case of doubt, responsible persons must supervise the use of the equipment.

Due to ongoing changes and software optimisations, the manual may have to be updated. If you notice any discrepancies during assembly or use, please refer to the manual uploaded to the webshop. The latest manual is always available there.

This equipment has been manufactured according to the latest safety knowledge. As far as possible, potential safety hazards which could cause injury have been eliminated. Make sure to carefully follow the instructions and that all parts are securely in place. If required, read through the instructions again to correct any mistakes.



Please pay close attention to the safety and maintenance instructions given here. The contract partner cannot be held liable for damage to health, accidents or damage to the equipment when it is not used in accordance with these instructions.

The following safety instructions may appear in this manual:

► **ATTENTION**

This notice indicates potentially hazardous situations which, if not avoided, may result in property damage.

⚠ **CAUTION**

This notice indicates potentially hazardous situations which, if not avoided, may result in slight or minor injuries!

⚠ **WARNING**

This notice indicates potentially hazardous situations which, if not avoided, may result in death or serious injuries!

⚠ **DANGER**

This notice indicates potentially hazardous situations which, if not avoided, will result in death or serious injuries!

ⓘ **NOTICE**

This notice indicates further useful information.

Retain these instructions in a safe place for future reference, maintenance or when ordering replacement parts.

1.1 Technical Data

LCD Display:

- + Speed in km/h
- + RPM (Revolutions per minute)
- + Training duration in min.
- + Distance in km
- + Calories burned in kcal
- + Heart rate (using the hand pulse sensors or a chest strap)
- + Watts

Resistance system: Electro-magnetic induction brake
Resistance levels: 32

Wattage
Adjustable range in the watt programme: 10-350 W
Min. and max. Watt at 60 RPM: 50-400 W
Min. and max. Watt at 100 RPM: 148-765W

Training programmes in total: 23
Quick-Start programmes: 1
Target programmes: 4
Heart rate programmes: 4
Pre-set programmes: 12
User defined programmes: 1
Watt programmes: 1
Recovery function: 1
Body fat test: 1

Flywheel mass: 10 kg
Transfer ratio: 1 : 8.75

Stride length: 58.4cm

Weight and dimensions:

Article weight (gross, incl. packaging): 112kg
Article weight (net, without packaging): 95kg
Packed dimensions (L x W x H) approx.: 221 cm x 88 cm x 45 cm
Set-up dimensions (L x W x H) approx.: 232cm x 95cm x 172cm

Maximum user weight: 180kg

1.2 Personal Safety

DANGER

- + Before you start using the equipment, you should consult your physician that this type of exercise is suitable for you from a health perspective. Particularly affected are persons who: have a hereditary disposition to high blood pressure or heart disease, are over the age of 45, smoke, have high cholesterol values, are overweight and/or have not exercised regularly in the past year. If you are under medical treatment that affects your heart rate, medical advice is absolutely essential.
- + Note that excessive training can seriously endanger your health. Please also note that heart rate monitoring systems can be inaccurate. If you notice any signs of weakness, nausea, dizziness, pain, shortness of breath, or other abnormal symptoms, stop exercising immediately and seek advice from your doctor if necessary.

WARNING

- + This equipment may not be used by children under the age of 14.
- + Children should not be allowed unsupervised access to the equipment.
- + Persons with disabilities must have a medical license and must be under strict observation when using the equipment.
- + The equipment is strictly for use by one person at a time.
- + If your equipment provides a safety key, the clip of the safety key must be attached to your clothing before starting your training. In the event of a fall, the EMERGENCY STOP of the equipment can be initiated.
- + Keep your hands, feet and other body parts, hair, clothing, jewellery and other objects well clear of moving parts.
- + During use, wear suitable sports clothing rather than loose or baggy clothing. When wearing sports shoes, make sure they have suitable soles, preferably made of rubber or other non-slip materials. Shoes with heels, leather soles, studs or spikes are unsuitable. Never exercise barefoot.

CAUTION

- + If your equipment needs to be connected to the power supply with a mains cable, make sure that the cable is not a potential tripping hazard.
- + Make sure that nobody is within the range of motion of the equipment during training so as not to endanger you or other persons.

ATTENTION

- + Do not insert any objects of any kind into the openings of the device.

1.3 Electrical Safety

DANGER

- + In order to reduce the risk of an electric shock, always unplug the equipment from the mains socket immediately after your workout, before assembly or dismantling, and before maintenance or cleaning. Do not pull on the cable.

WARNING

- + Do not leave the equipment unattended while the mains cable is plugged into the mains socket. During your absence, the mains cable must be removed from the mains socket to prevent improper use by third parties or children.
- + If the mains cable or plug is damaged or defective, contact your contract partner. Until repair, the equipment must not be used.

ATTENTION

- + The equipment requires a mains connection of 220-230 V with 50 Hz mains voltage.
- + The equipment may only be connected directly to an earthed socket using the supplied mains cable. Extension cables must conform to VDE guidelines. Always completely unwind the mains cable.
- + The socket must be protected by a fuse with a minimum fuse rating of "16 A, slow blow".
- + Do not make any changes to the mains cable or the mains plug.
- + Keep the mains cable away from water, heat, oil and sharp edges. Do not route the mains cable underneath the equipment or under a carpet or rug, and do not place any objects on top of it.

1.4 Set-Up Place

WARNING

- + Do not place the equipment in main corridors or escape routes.

CAUTION

- + The training room should be well ventilated during training and not be exposed to any draughts.
- + Choose the place in which to set up the equipment such that there is enough free space/clearance to the front, the rear and to the sides of the equipment.
- + The set-up and mounting surface of the equipment should be flat, loadable and solid.

ATTENTION

- + The device may only be used in one building, in sufficiently tempered and dry rooms (ambient temperatures between 10°C and 35°C). The equipment should not be used outdoors or in rooms with high humidity (over 70%) like swimming pools.
- + A floor protective mat/equipment underlay can help to protect high-quality floor coverings (parquet, laminate, cork, carpets) from dents and sweat and can help to level out slight unevenness.

2.1 General Instructions



DANGER

- + Do not leave any tools, packaging materials such as foils or small parts lying around, as otherwise there is a danger of suffocation for children. Keep children away from the equipment during assembly.



WARNING

- + Pay attention to the instructions attached to the equipment in order to reduce the risk of injuries.



CAUTION

- + Do not open the packaging when it is lying on its side.
- + Ensure to have sufficient room for movement in each direction during assembly.
- + The assembly of the equipment must be carried out by at least two adults. If in doubt, seek the help of a third technically skilled person.



ATTENTION

- + To prevent damage to the equipment and the floor, assemble the equipment on a mat or packaging board.



NOTICE

- + In order to make the assembly as simple as possible, some screws and nuts to be used can already be pre-assembled.
- + Ideally, assemble the equipment at its later set-up place.

2.2 Scope of Delivery

The scope of delivery consist of the following parts. At the beginning, check whether all parts and tools belonging to the device are included in the scope of delivery and whether damage has occurred. In the event of complaints, the contractual partner must be contacted directly.

⚠ CAUTION

If parts of the scope of delivery are missing or damaged, the assembly must not be carried out.

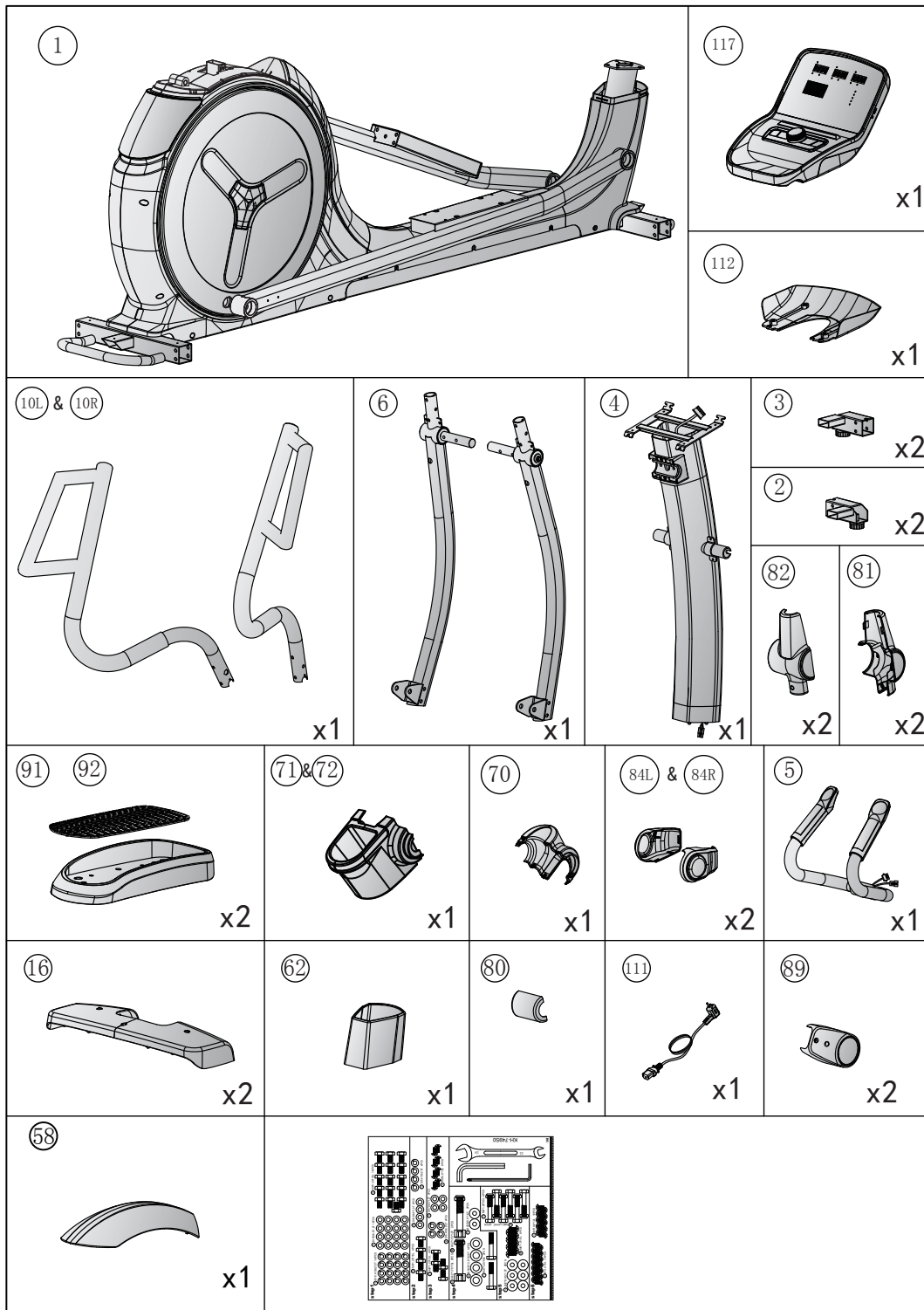

2.3 Assembly

Before assembly, take a close look at the individual assembly steps shown and carry out the assembly in the order given.

NOTICE

- + First loosely screw all parts together and check that they fit properly. Tighten the screws using the tool only when you are instructed to do so.
- + If you have difficulty recognising the graphics, we recommend that you open and/or download the PDF instructions stored in the webshop on your end device (e.g. smartphone, tablet or PC). There you have the option of zooming in closer. Please note that the Adobe Acrobat Reader programme must be installed on your end device in order to open the file.
- + The assembly can also be found as a video under the following link: <https://www.sport-tiedje.co.uk/taurus-x9.9-cross-trainer-tf-x99#product-assembly>. To go directly to the assembly video, you can alternatively scan the QR code.



Step 1: Mounting the front and rear feet

NOTICE

In the following step, please pay attention to the correct positioning of the feet (see fig.).

Place the cover (58) and screw the front and rear feet (2 & 3) onto the main frame (1), each with four hexagonal screws (13), four spring washers (12) and four washers (11).

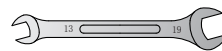

13		M8*1.25*15L	x16
12		D15.4*D8.2*2T	x16
11		D16*D8.5*1.2T	x16

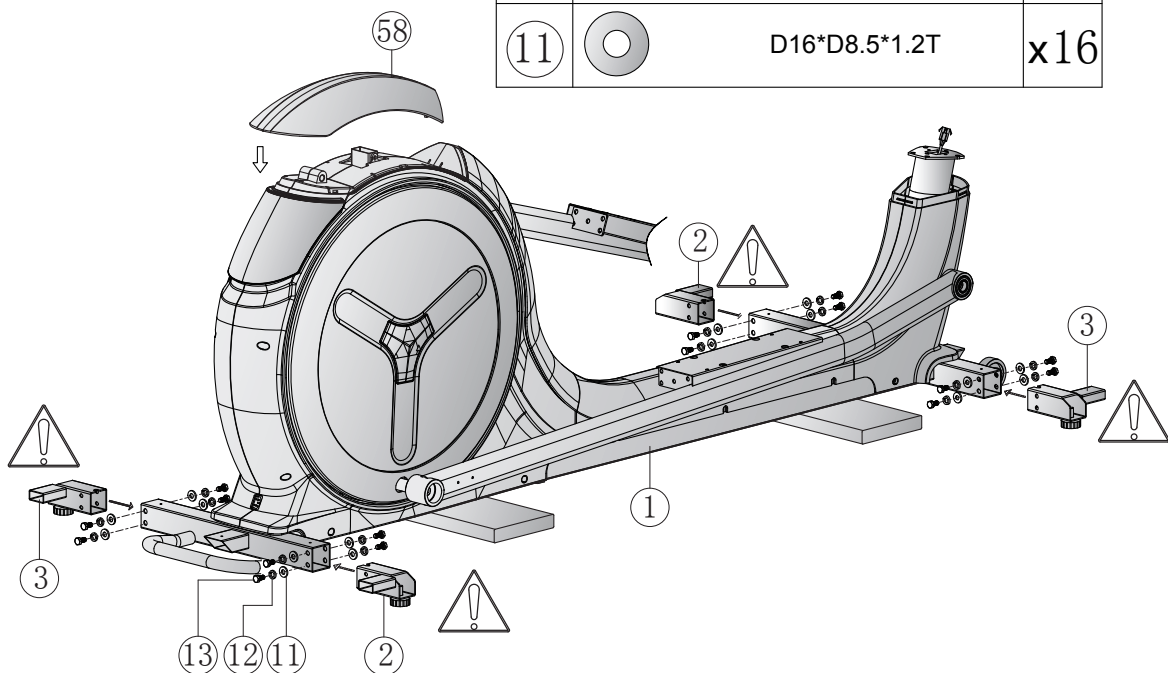

Step 2: Mounting the console mast

1. Slide the cover (62) up around the console mast (4) (see fig. 2-1) and connect cable (98) to cable (99) (see fig. 2-2).
2. Place the console mast (4) in the holder in the main frame (1) and screw it in with four hexagonal screws (13), four spring washers (12) and four washers (11).
3. Slide the cover (62) down and clip it into place.

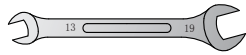

13		M8*1.25*15L	x4
12		D15.4*D8.2*2T	x4
11		D16*D8.5*1.2T	x4

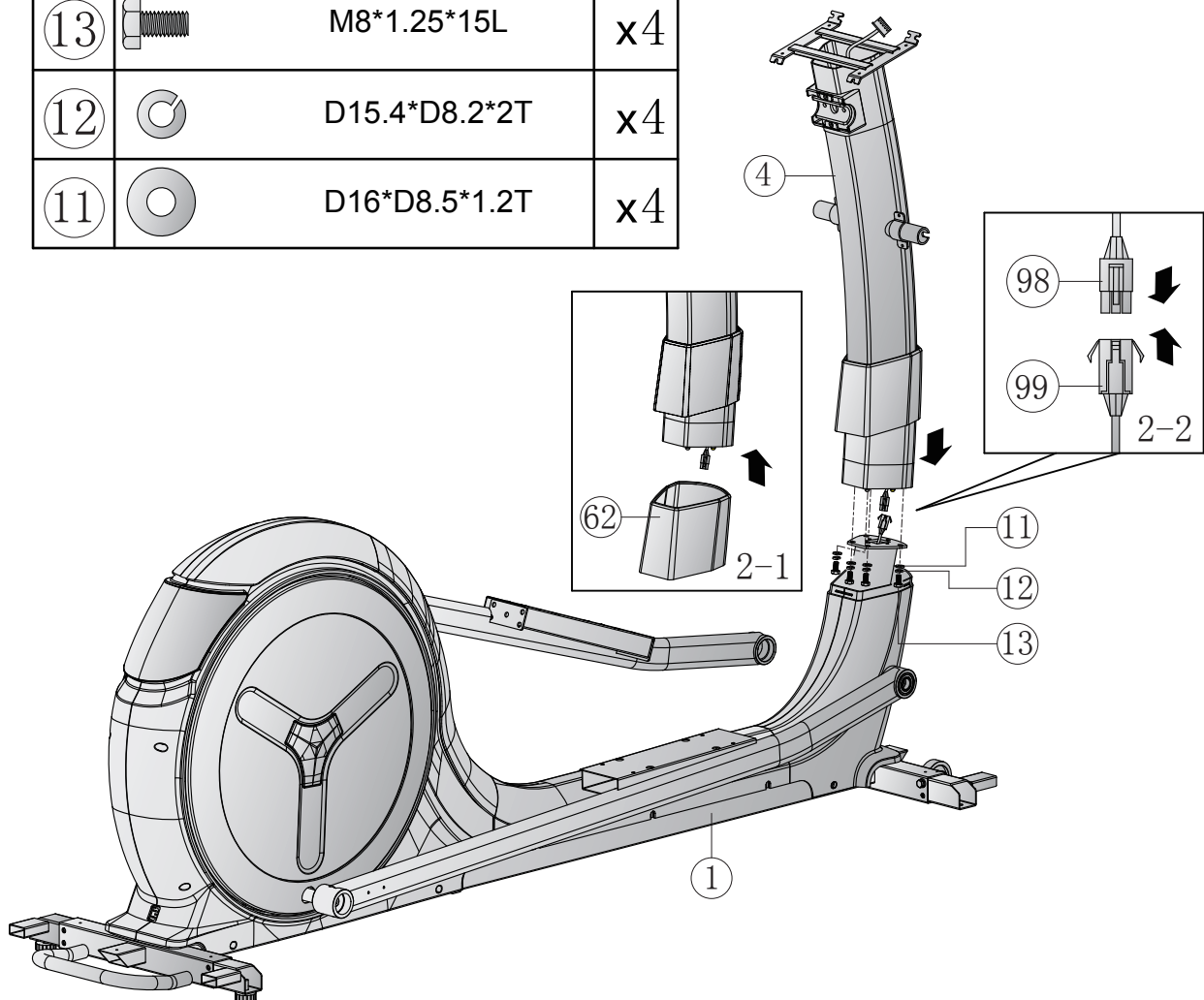

Step 3: Mounting the console and arms

1. Mount the left and right poles (6) onto the console mast (4) with two hexagonal screws (13), two spring washers (12) and four washers (11) each.
2. Connect cable (117) to cable (98) (see fig. 3-1).
3. Place the console (117) on the console mast (4) and screw into place with four screws (17) (see fig. 3-2). Place the cover (112) under the console (117) and screw into place with four screws (17) (see fig. 3-3).



13		M8*1.25*15L	x4
12		D15.4*D8.2*2T	x4
11		D16*D8.5*1.2T	x4
17		M5*0.8*12L	x8

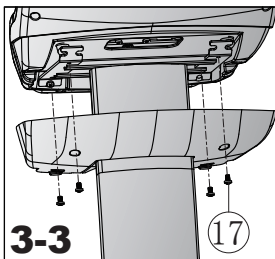
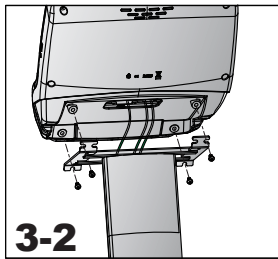
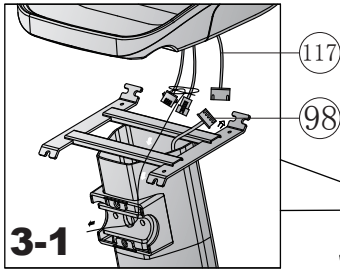
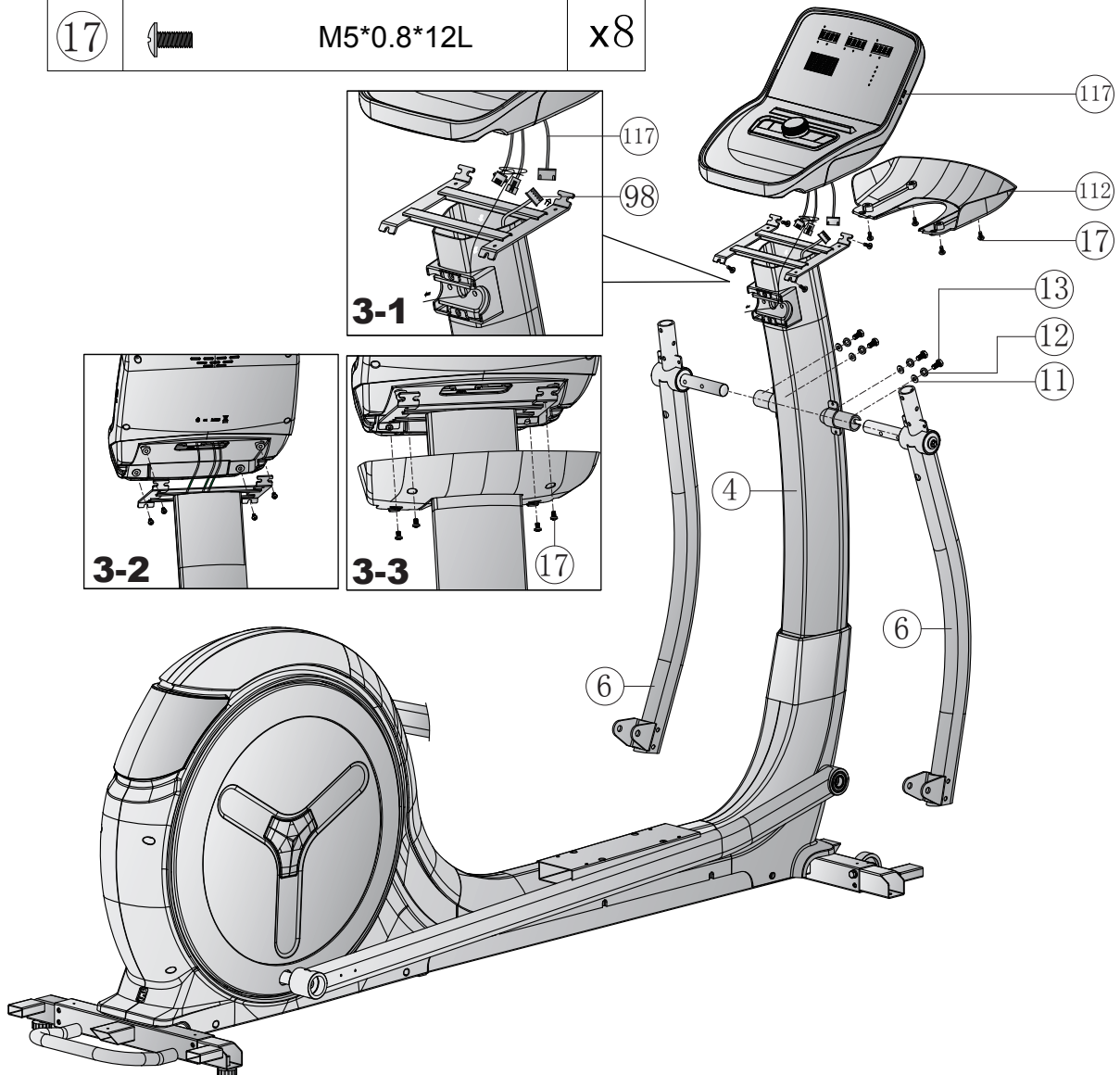

Step 4: Mounting the pedal rails and handlebar

1. Connect the cables (117 & 102) and the cables (117 & 103) with each other (see fig. 4-1).
2. Mount the handlebar (5) onto the console mast (4) with two hexagonal screws (73) and two curved washers (74). Place the cover (80) on the handlebar (5) over the screw connection.
3. Screw the left and right poles (6) together with the left and right pedal rails (7L & 7R), each with one hexagonal screw (86), two washers (87) and one locking nut (88) (see fig. 4-2).



86		M12*1.75*70L	x2
87		D24*D13.5*D2.5T	x4
88		M12*1.75*12T	x2
73		M8*1.25*50L	x2
74		D22xD8.5x1.5T	x2

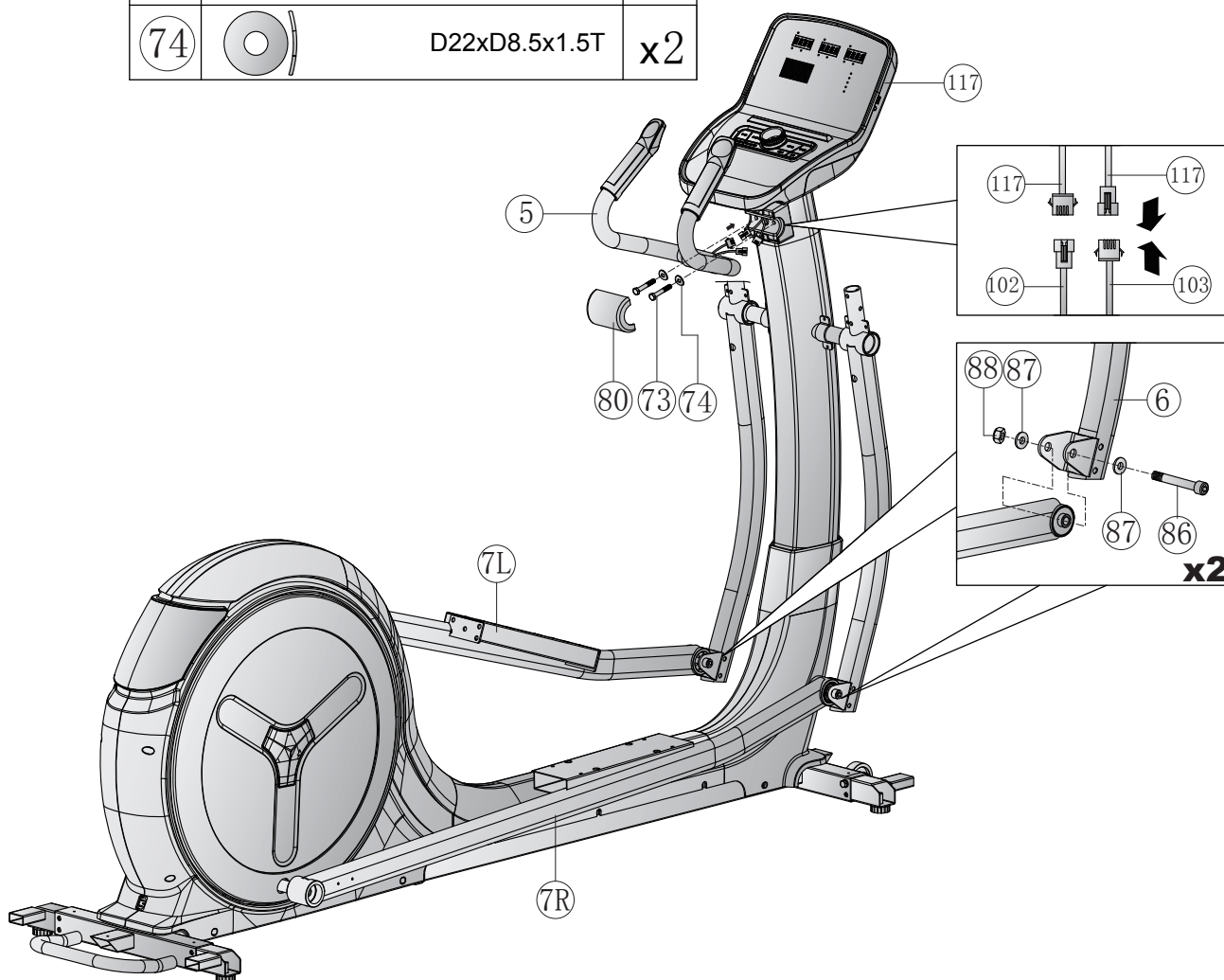

Step 5: Mounting the handles and pedals

1. Mount the right handle (10R) onto the right pole (6) with three hexagonal screws (73), three curved washers (74) and three locking nuts (20) (see fig. 5-1).
2. Mount the left handle (10L) onto the left pole (6) with three hexagonal screws (73), three curved washers (74) and three locking nuts (20) (see fig. 5-2).
3. Mount the pedals (91) onto the pedal rails (10r & 10L), each with four screws (96). Place the pedal pads (92) onto the pedals (91).



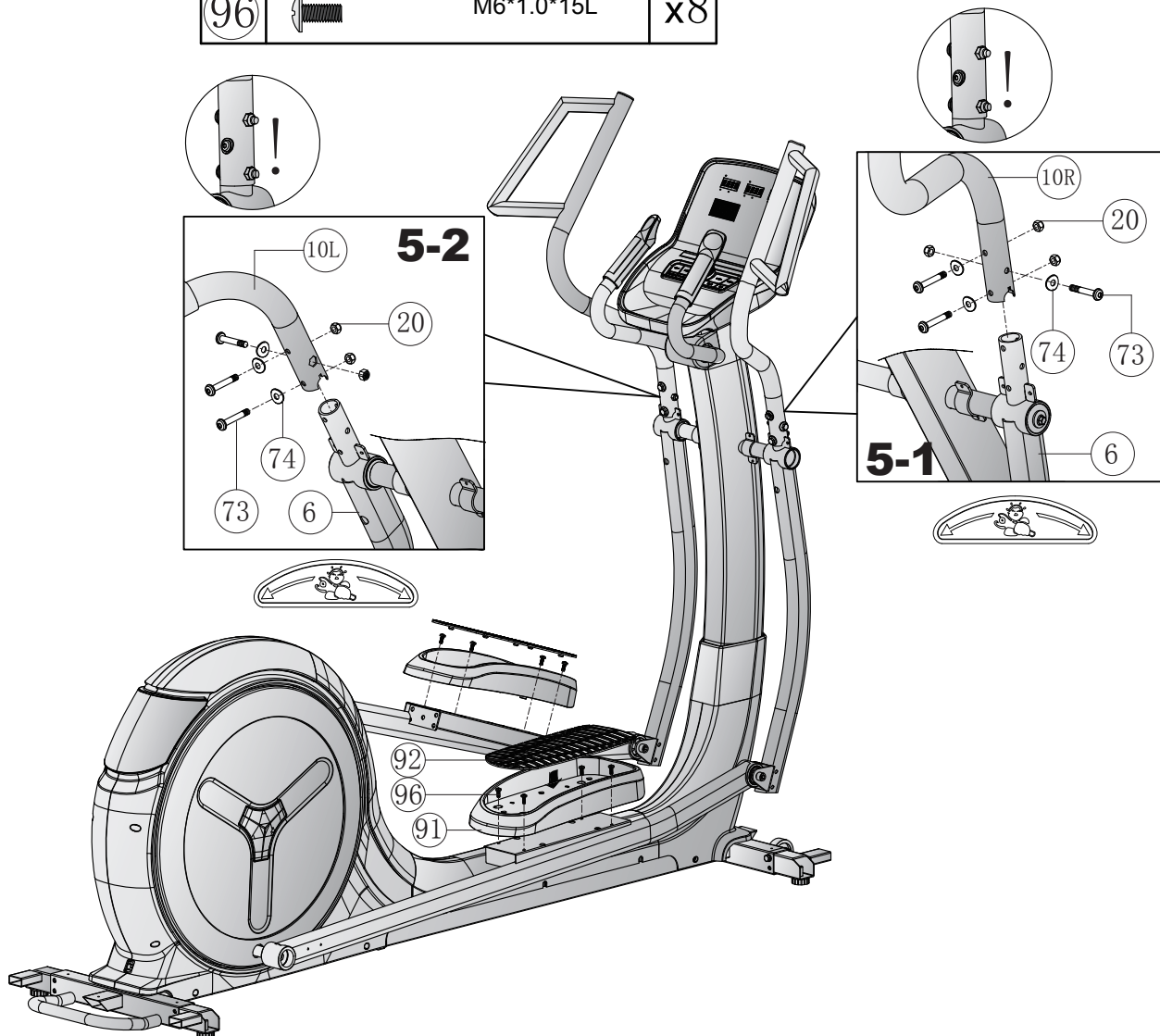

73		M8*1.25*50L	x6
74		D22xD8.5x1.5T	x6
20		M8*1.25*8T	x6
96		M6*1.0*15L	x8



Step 6: Mounting the covers

1. Assemble the drink bottle holder parts (71 & 72) together and screw into place on the console mast (4) with four screws (64). Click the front drink bottle holder cover (70) onto the drink bottle holder (71) (see fig. 6-1).
2. Mount the pole covers (81 & 82) onto the left and right poles (6), each with three screws (64) (see fig. 6-2).
3. Mount the covers (84L & 84R) onto the pedal rails (10L & 10R), each with two screws (64) (see fig. 6-3).
4. Mount the left and right axial covers (89) onto the pedal rails (10L & 10R), each with two screws (17).
5. Mount the foot covers (16) onto the feet (2 & 3), each with three screws (17).
6. Now hand tighten all screws.



64		ST4.2*15L	x14
17		M5*0.8*12L	x10

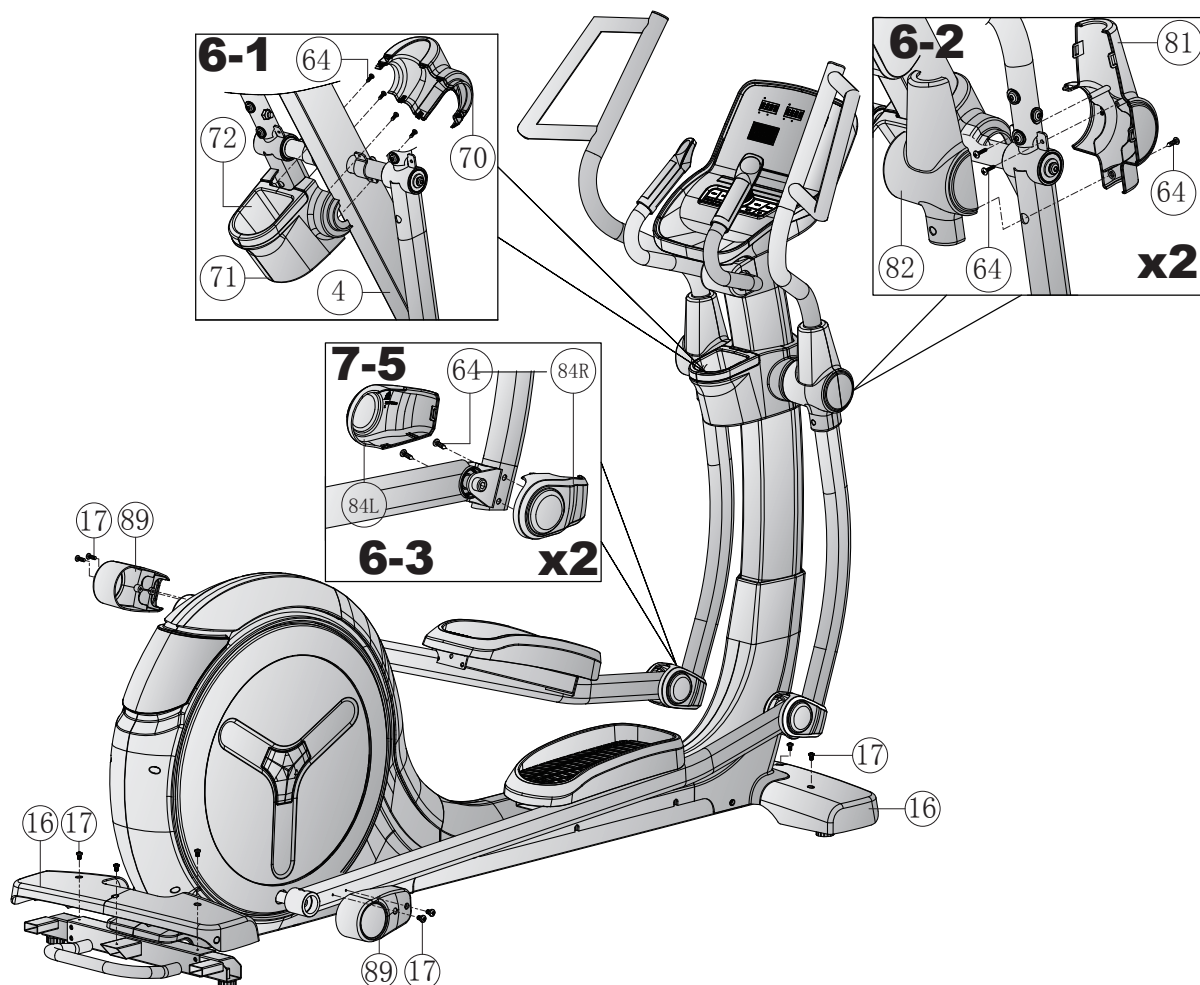

Step 8: Adjusting the feet

The crosstrainer can be stabilised on un-even surfaces with the adjustable feet.

1. Lift up the crosstrainer on one side to gain access to the adjustable feet underneath the frame.
2. Turn the screw clockwise to unscrew the foot, lifting the crosstraining at that point.
3. Turn the screw anti-clockwise to lower the crosstrainer at that point.

Step 9: Connecting the crosstrainer to the mains supply

► ATTENTION

The crosstrainer should not be plugged into a power board, as it cannot be guaranteed that the crosstrainer will be supplied with sufficient power. This could also lead to technical errors occurring.

Firstly connect the power cord (117) to the crosstrainer and then plug it into the wall socket, making sure the electrical prerequisites covered in the chapter about electrical safety are met.



3 OPERATING INSTRUCTIONS

NOTICE

Familiarise yourself with all the functions and setting options of the device before starting training. Have the proper use of this product explained to you by a specialist.

3.1 Console display

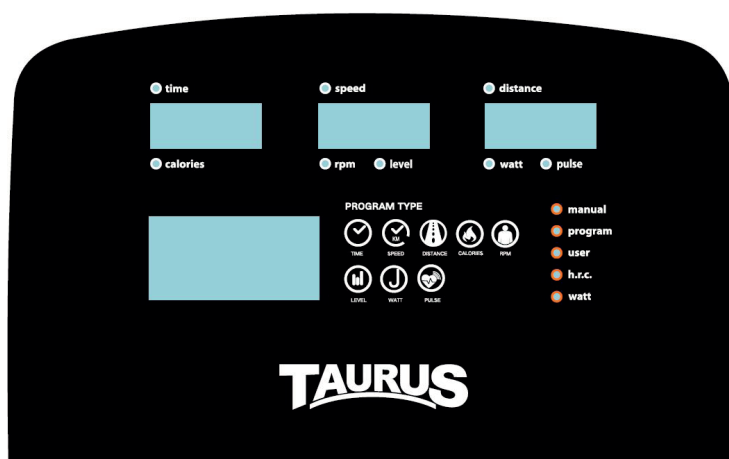

DISPLAY	DESCRIPTION
TIME	+ Display of the elapsed training time (0:00 - 99:59) + Set a target time with the rotary knob (0:00 - 99:00) in 1 min. increments-
SPEED	Display of the current speed (max. 99.9)
DISTANCE	+ Display of the distance covered (0.00-99.99) + Set a target distance with the rotary knob (0.00-99.0) in 1km increments
CALORIES	+ Display of the calories burned (0-9999) + Set a target calorie value with the rotary knob (0-9999) in 10 Cal. increments-
RPM	Display of the current revolutions per minute (RPM) (0-999)
LEVEL	Display of the current resistance level
WATTS	Display of the Watt value (0 -999)
PULSE	+ Display of your heart rate (0-230) + Set a heart rate target with the rotary knob (0-30-230) in singular increments

3.2 Button functions

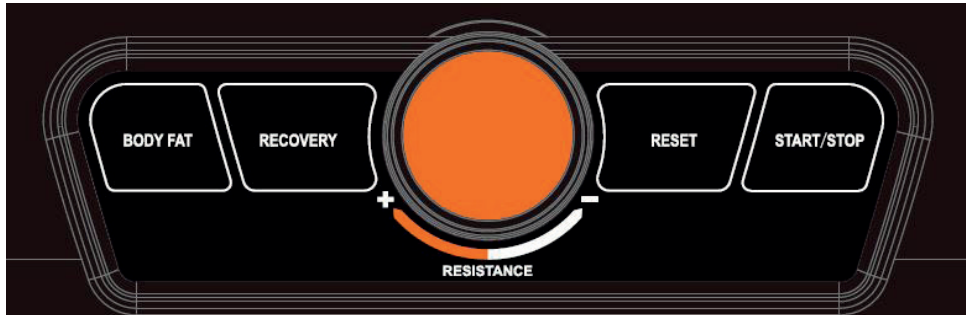

BUTTON	DESCRIPTION
Rotary knob	+ Increasing the setting value or resistance level + Decreasing the setting value or resistance level + Setting confirmation
BODY FAT	Body fat test
RECOVERY	Heart rate test on your recovery condition
RESET	Returns you to the previous training mode while making settings or selecting an option. To reset the console, press and hold the button for 2 seconds
START/STOP	Start and stop your training

3.3 Powering on the crosstrainer

The console starts automatically as soon as the crosstrainer is plugged into the mains supply. Various components will light up.

1. Choose a user profile (U1 - U4).
2. Enter in your gender (SEX), age (AGE), height (HEIGHT) and weight (WEIGHT).

You will proceed onto the main menu.

In the main menu you can choose from the different programmes.

- + MANUAL (Quick-Start and target programmes)
- + PROGRAM (Profile programmes)
- + USER PROGRAM (user defined programme)
- + H.R.C (Heart rate controlled programmes)
- + WATT (Watt programme)

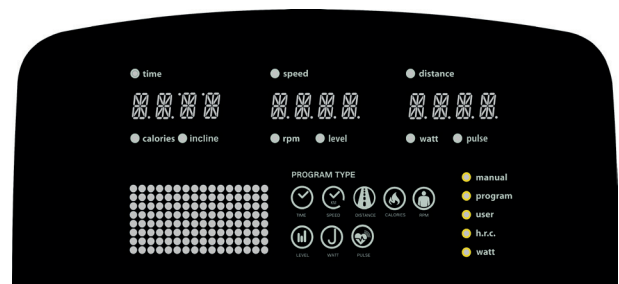
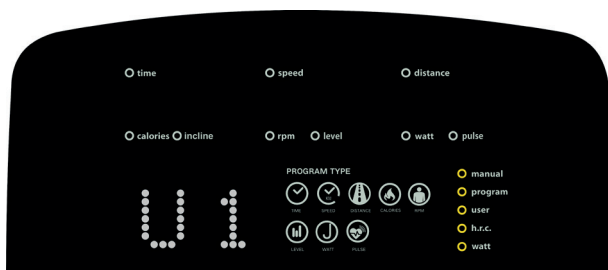

3.4 Standby mode

The console goes into standby mode after four minutes without inputs or movement- The console will exit standby mode as soon as it registers movement.

3.5 MANUAL (Manual programmes)

Under MANUAL you can choose between the Quick-Start programme and one of the target programmes. For target programmes, settings for time (TIME), distance (DISTANCE), calories (CALORIES) or heart rate (PULSE) are possible.

3.5.1 Quick-Start programme

1. In the main menu, select MANUAL and confirm your choice with a single push of the rotary knob.
2. To start the Quick-Start programme, just press the START/STOP button.

Various values will start counting upwards.

3. To pause the programme, press the START/STOP button again.
4. To end the programme, press the RESET button.



3.5.2 Target programmes

You have two choices for target programmes. The target programme can have a singular or multiple targets set.

Training with a singular target value

1. In the main menu select MANUAL and confirm your choice with a single push of the rotary knob.
2. Select your target value for time, calories, distance or heart rate with the rotary knob and confirm your choice with a single push of the rotary knob.

WARNING

This crosstrainer is not medical equipment. The heart rate measurement of the crosstrainer can be unprecise. Different factors can influence the heart rate reading. The heart rate readings are only meant as a guide for training.

3. To start the programme, press the START/STOP button.

NOTICE

During training it is possible to change the resistance level with the rotary knob.

The target value counts down and the other values count upwards.

4. To pause the programme, press the START/STOP button again.
5. To end the programme, press the RESET button.

Training with multiple target values

1. In the main menu select MANUAL and confirm your choice with a single push of the rotary knob.
2. Select your target value for time, calories, distance and/or heart rate with the rotary knob and confirm your choice with a single push of the rotary knob.



WARNING

This crosstrainer is not medical equipment. The heart rate measurement of the crosstrainer can be unprecise. Different factors can influence the heart rate reading. The heart rate readings are only meant as a guide for training.

3. To start the programme, press the START/STOP button.

NOTICE

During training it is possible to change the resistance level with the rotary knob.

The target values count down and the other values count upwards.

4. To pause the programme, press the START/STOP button again.
5. To end the programme, press the RESET button.

3.6 PROGRAM (Profile programmes)

There are a total of 12 profile programmes available to choose from.

1. In the main menu select PROGRAM and confirm your choice with a single push of the rotary knob.
2. Using the rotary knob select one of the profile programmes and confirm your choice with a single push of the rotary knob.
3. Using the rotary knob select the training time and confirm the setting with a single push of the rotary knob.



4. To start the programme, press the START/STOP button.

NOTICE

During training it is possible to change the resistance level with the rotary knob.

5. To pause the programme, press the START/STOP button again.

NOTICE

While the programme is paused it is possible to change the training time.

6. To end the programme, press the RESET button.

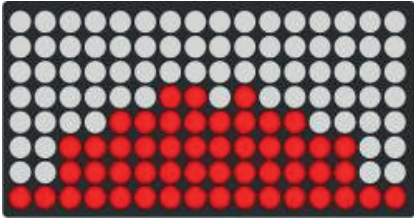

P1

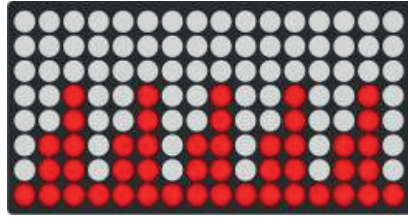

P2

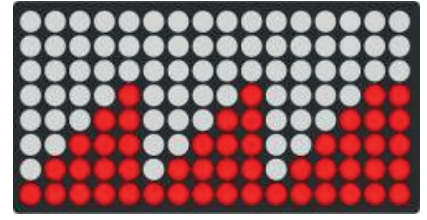

P3

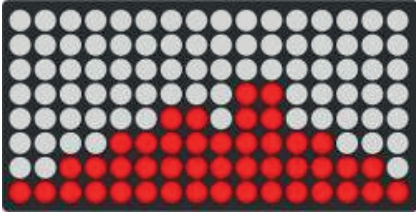

P4



P5



P6

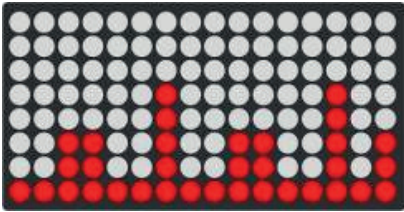

P7

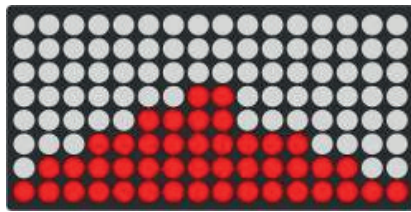

P8

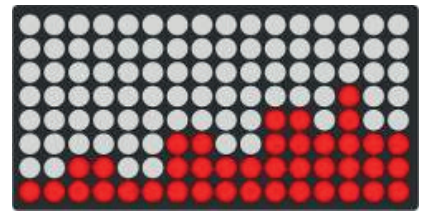

P9

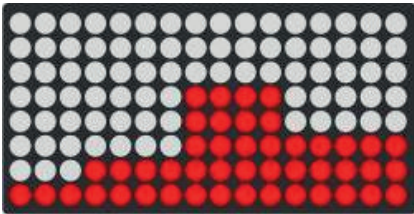

P10

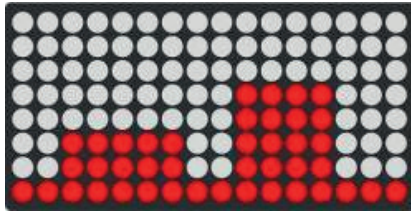

P11

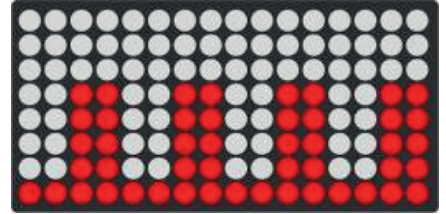

P12

3.7 USER (User defined programme)

There are 16 segments available in user defined programmes.

1. In the main menu select USER and confirm your choice with a single push of the rotary knob.
2. Select the resistance level of each segment and confirm each value with a single push of the rotary knob.
3. To end setting the resistance levels, press and hold the rotary knob for 2 seconds.

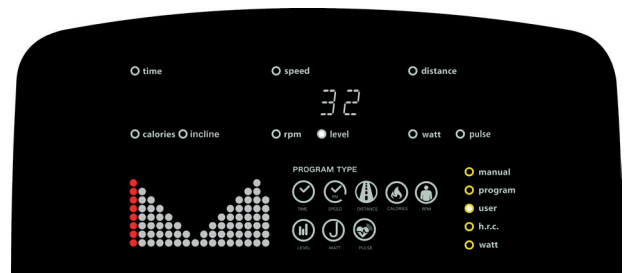

The last set level is shown on the display.

You now have the option to set training time with the rotary knob.

4. Using the rotary knob, select the training time and confirm the setting with a single push of the rotary knob or press the START/STOP button to directly start your training.

NOTICE

During training it is possible to change the resistance level with the rotary knob.

5. To pause the programme, press the START/STOP button again.
6. To end the programme, press the RESET button.

3.8 H.R.C. (Heart rate controlled programmes)

WARNING

This crosstrainer is not medical equipment. The heart rate measurement of the crosstrainer can be unprecise. Different factors can influence the heart rate reading. The heart rate readings are only meant as a guide for training.

There are four heart rate programmes available to choose from. You can choose from one of the three pre-set target heart rate programmes (55%, 75% or 90% of your maximum heart rate) or choose TARGET and manually set a target heart rate value. Your maximum heart rate is calculated by the console and is dependant on your age set. We recommend using a chest heart rate sensor (chest strap) for this programme.



1. In the main menu select H.R.C. and confirm your choice with a single push of the rotary knob.
2. Using the rotary knob select one of the pre-set target heart rate programmes or TARGET and confirm your choice with a single push of the rotary knob.
3. If you have selected TARGET, use the rotary knob select a target heart rate and confirm your setting with a single push of the rotary knob.

NOTICE

The pre-set TARGET value is 100.

- 3.1. Optionally you can also set a time and confirm this with a single push of the rotary knob.
4. To start the programme, press the START/STOP button and hold the hand pulse sensors in your hands or alternatively you can use an optional chest strap.

Your current heart rate will be displayed during training.

NOTICE

If no heart rate is detected, the display will show:



5. To pause the programme, press the START/STOP button again.
6. To end the programme, press the RESET button.

3.9 WATT (Watt programme)

1. In the main menu select WATT and confirm your choice with a single push of the rotary knob.
2. Using the rotary knob, select a Watt value and confirm your setting with a single push of the rotary knob.



NOTICE

The pre-set value is 120.

3. Using the rotary knob select the training time and confirm the setting with a single push of the rotary knob or press the START/STOP button to directly start your training.

NOTICE

The resistance level changes automatically to the set Watt value.

4. To pause the programme, press the START/STOP button again.
5. To end the programme, press the RESET button.

3.10 RECOVERY (Recovery function)

Use the recovery function after a training session to measure your recovery heart rate.

To start the recovery function, press the RECOVERY button and hold the hand pulse sensors or alternatively use an optional chest strap.

The display shows a countdown that runs from 00:60 to 00:00.



NOTICE

If you wish to prematurely end the recovery function, press the RECOVERY button again.

Based on the final pulse readings, once the countdown ends you'll receive a fitness grade from F1 to F6.

F1	Very good
F2	Good
F3	Average
F4	Adequate
F5	Bad
F6	Very bad

3.11 BODY FAT (Body fat analysis)

1. Choose your user profile (U1-U4).
2. To start the body fat analysis, in the main menu press the BODY FAT button and hold on to the hand pulse sensors.

NOTICE

Should you not properly grip the hand pulse sensors, the display will show the error code E-1.

NOTICE

If you wish to prematurely end the body fat analysis and return to the previous program, press the BODY FAT button again.

After successfully ending the test you'll be shown your body fat ratio (FAT%) and your BMI.

NOTICE

Should your body fat ratio be outside of the 5% - 50%, the display will show the error code E-4.

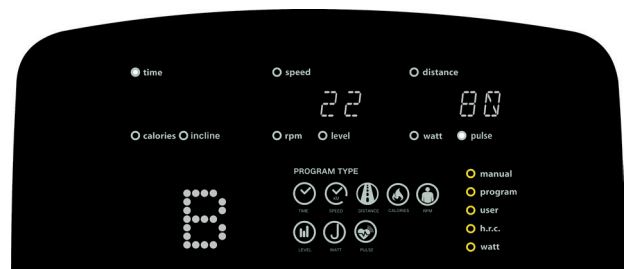
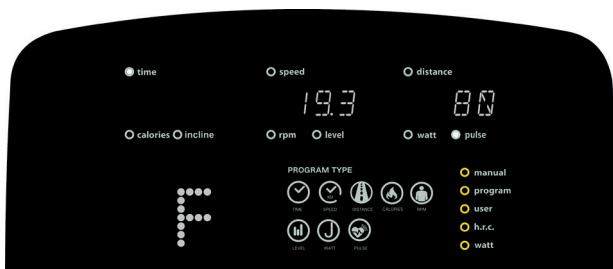

3.12 Bluetooth and fitness apps

This console is equipped with a bluetooth interface. To use training apps you will have to connect your treadmill with your mobile device (tablet or smart phone). To do this, please activate the bluetooth function on your mobile device. Now choose your treadmill.

Please take note that your mobile device needs to be compatible with the bluetooth interface of the treadmill (bluetooth 4.0). Now start the fitness app. It might happen that you need to connect both the app and the console additionally. To do this, please follow the instructions given in the app.

You will find the fitness apps in the app stores of Google or Apple. There you will find the apps „Kinomap“ or „iconsole3“. Please note that these apps are produced by an external manufacturer. Sport-Tiedje does not take any responsibility regarding the availability, functionality or contents of these programmes.

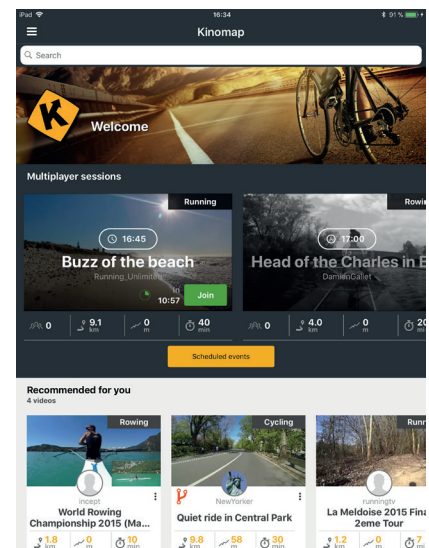
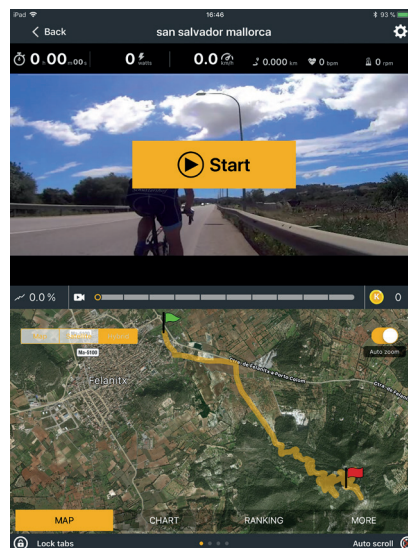
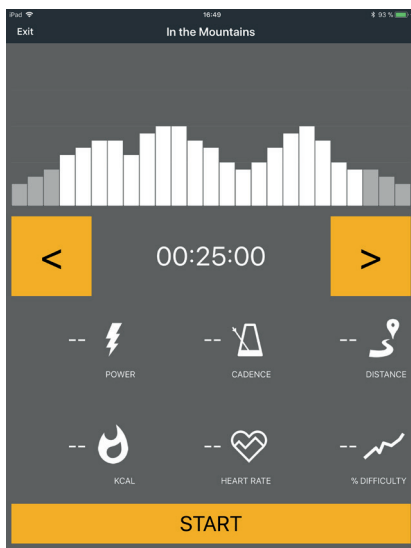

Example: Kinomap

4.1 General Instructions

▶ ATTENTION

- + Make sure that the equipment is protected from moisture, dust and dirt in the selected storage location. The storage location should be dry and well ventilated and have a constant ambient temperature between 5°C and 45°C.

⚠ WARNING

- + The storage location should be chosen so that improper use by third parties or children can be prevented.
- + If your equipment does not have transportation wheels, the equipment must be disassembled before transportation.

4.2 Transportation Wheels

▶ ATTENTION

If you want to transport your equipment over particularly sensitive and soft floor coverings, such as parquet, planks or laminate, lay out the transport route with cardboard or similar to avoid possible floor damage.

1. Stand behind the equipment and lift it until the weight is transferred to the transportation wheels. After that, you easily can move the equipment to a new position. For long transport distances the equipment should be disassembled and safely packed.
2. Select the new location by following the instructions in the section 1.4 of this manual.

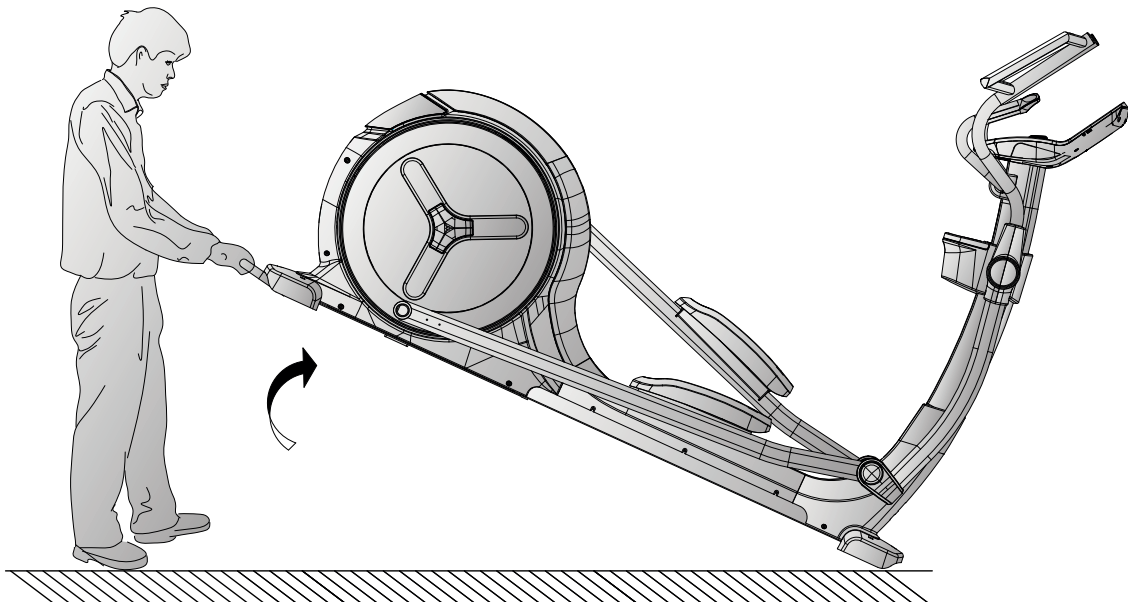

5.1 General Instructions

⚠ WARNING

- + Do not make any improper changes to the equipment.

⚠ CAUTION

- + Damaged or worn components may affect your safety and the life of the equipment. Therefore, immediately replace damaged or worn components. In such a case, contact the contract partner. The equipment must not be used until it has been repaired. If necessary, use only original spare parts.

▶ ATTENTION

- + In addition to the instructions and recommendations for maintenance and care given here, additional service and/or repair work may be necessary; this must only be carried out by authorised service technicians.

5.2 Faults and Fault Diagnosis

The equipment undergoes regular quality controls during production. Nevertheless, faults or malfunctions may occur. Frequently, individual parts are responsible for these disturbances, an exchange is usually sufficient. Please refer to the following overview for the most common errors and how to correct them. If the equipment still does not function properly, contact your contract partner.

Fault	Cause	Solution
The drive disc is wobbling or producing noises	Drive disc is loose	Tighten the nut
Display doesn't function	Cables not properly connected	Check all cable connections
Pedals are squeaking	Pedals are loose	Tighten the screws in the pedals
Squeaking noises	Screws have loosened	Check that all the screws are tightened
Rails are squeaking	The rails and/or wheels are dirty or the rails are dry	Clean the rails and wheels Re-lubricate the rails with fat-free silicon
No pulse displayed	<ul style="list-style-type: none"> + Source of interference in the room + Chest strap is not compatible + Position of the chest strap is incorrect + Batteries are empty 	<ul style="list-style-type: none"> + Eliminate the source of interference (e.g. Mobile, Speakers, etc.) + Use a compatible chest strap (see recommended accessories) + Re-position the chest strap and/or moisten the electrode(s) + Change the batteries

5.3 Error codes and troubleshooting

The electronics of the crosstrainer are continually running tests. In case of deviations, an error code is shown on the display and normal operation is stopped for your safety.

- + E-1 No values were received during the body fat analysis. Make sure that, during the analysis, you hold on to the hand pulse sensors with both hands.
- + E-4 The user settings entered for age, height, weight or the body fat ratio is outside of the setting range.

5.4 Maintenance and Inspection Calendar

To avoid damage from body sweat, the equipment must be cleaned with a damp towel (no solvents!) after each training session.

The following routine tasks must be performed at the specified intervals:

Part	Weekly	Monthly	Quarterly
Display console	C	I	
Slide rails*		C	
Lubrication of slide rails and moving parts*			I
Plastic covers	C	I	
Screws and cable connections		I	
Legend: C = clean; I = inspect			

*Make sure to always clean the slide rails and moving parts before re-lubricating.

By scanning the QR code with the camera function or QR code scanner app of your smartphone/tablet, a video on general maintenance of a crosstrainer opens on YouTube. The video serves to illustrate the maintenance points described in this manual.

Please note that the video may not be available in your language or with appropriate subtitles.

If you cannot scan QR codes, you can access all Sport-Tiedje videos on YouTube by first opening YouTube and entering "Sport-Tiedje" in the search field.



6 DISPOSAL

At the end of its operational life, this equipment cannot be disposed of in normal household waste. Instead, it must be disposed of via an electricals recycling centre. Further information can be obtained from your local authority's recycling service.



The materials can be recycled as per their symbols. Through the reuse, recycling of materials or other forms of recovery of old equipment, you make an important contribution to the protection of the environment.

7 RECOMMENDED ACCESSORIES

To make your training experience even more efficient and pleasant, we recommend that you add suiting accessories to your fitness equipment. This could be a floor mat, for example, which makes your fitness equipment stand more securely and also protects the floor from falling sweat, but it could also be additional handrails on some treadmills or silicone spray to keep moving parts in good shape.

If you have purchased a fitness machine with pulse training and want to train your heart rate, we strongly recommend that you use a compatible chest strap, as this ensures optimum transmission of the heart rate. You may want to buy additional grips or weights for multi gyms.



Our range of accessories offers the highest quality and makes training even better. If you would like to find out more about compatible accessories, please go to the detail page of the product in our webshop (the easiest way is to enter the article number in the search field above) and go to the recommended accessories on this page. Alternatively, you can use the QR code provided. Of course, you can also contact our customer service: by telephone, e-mail, in one of our branches or via our social media channels. We will be happy to advise you!



chest strap



floor mat



lubricant

8.1 Serial Number and Model Name

In order to provide you with the best possible service, please have the model name, article number, serial number, exploded drawing and parts list ready. The corresponding contact options can be found in chapter 10 of this operating manual.

NOTICE

The serial number of your equipment is unique. It's located on a white sticker. The exact position of this sticker is shown in the following illustration.

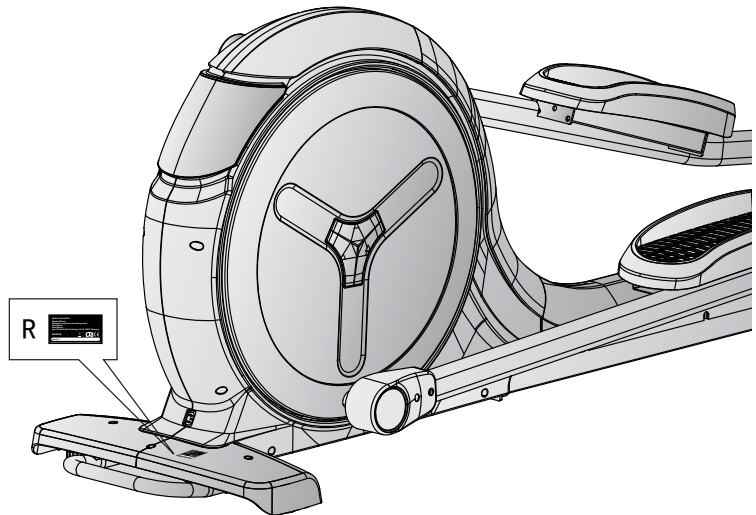

Enter the serial number in the appropriate field.

Serial number:

Brand / Category:

Model Name:

SKU:

8.2 Parts List

No.	Name	Supplier Parts No.	Specification	Qty.
1	main frame	749S0-3-1000-J0		1
2	front stabilizer	749S0-3-2100-J1		2
3	rear stabilizer	749S0-3-2112-J1		2
4	handlebar post welding	749S0-3-2000-J0		1
5	handlebar welding	749S0-3-2400-J0		1
6	supporting tube for movable handlebar	749S0-3-3700-J0		2
7R	right pedal bottom tube welding set	749S0-3-3811-J0		1
7L	left pedal bottom tube welding set	749S0-3-3810-J0		1
8	crank welding set	749S0-3-2700-J0		2
9	ideal wheel	747S0-3-1600-00		1
10R	left dipped foam	58015-6-1396-B0	D38*4T	1
10L	right dipped foam	58015-6-1397-B0	D38*4T	1
11	flat washer	55108-1-1612-FA	D16*D8.5*1.2T	24
12	spring washer	55108-2-1520-FA	D15.4 XD8.2x2T	24
13	hex bolt	50108-5-0015-F0	M8*1.25*15L,8.8	24
14	adjustable wheel	26000-6-1095-B0	D38*M10*1.5	5
15	hex nut	55210-2-2008-FA	M10*1.5*8T	5
16	cover for rear stabilizer	734S0-6-2186-B0	600*190.2*79.4	2
17	cross screw	52605-5-0012-F0	M5*0.8*12L,8.8	36
18	moving wheel	26100-6-1087-B0	D65*24	2
19	allen bolt	50308-5-0040-F3	M8*1.25*40L,8.8	2
20	anti-loose nut	55208-1-2008-FA	M8*1.25*8T	9
21	flat washer	55110-1-2020-NA	D20*D11*2t	1
22	c-clip	55517-1-0010-00	S-17(1T)	1
23	waved washer	55117-5-2203--DA	D17*D22*0.3T	3
24	bearing	58006-6-1026-01	6203-2RS	2
25	flat washer	55108-1-2830-NA	D28*D8.5*3T	1
26	hex nut	55208-2-2006-NA	M8*1.25*6T	1
27	hex bolt	50108-5-0030-C4	M8*1.25*30L,8.8, 20L	1

28	plastic flat washer	55110-1-5010-BF	D50*D10*1.0T	1
29	anti-loose nut	55206-1-2006-CA	M6x1.0x6T	2
30	hex bolt	50106-2-0075-N0	M6*75L	1
31	fix plate	815G0-6-1673-N0	20*27*4T	2
32	allen screw	54006-5-0015-D0	M6*1.0*15L,8.8	6
33	hex nut	55206-2-2005-NA	M6*1*5T	2
34	bearing	58006-6-1057-00	#6205ZZ,NBK	2
35	allen bolt	54010-8-0065-F6	M10*1.5*65L,12.9	2
36	hex nut	55210-A-2008-FA	M10*1.5*8T 8.8	4
37	spacer	75000-6-2781-01	D29.5*D25.2*9T	1
38	hex bolt	50108-2-0020-U0	M8*1.25*20L	4
39	flat washer	55108-1-2115-CA	D21*D8.5*1.5T	2
40	sleeve	747S0-6-2707-00	D30*D25.2*45L	1
41	poly belt	58004-6-1115-00	540 PJ8	1
42	pulley Wheel	58008-6-1036-D0	D350*29.9*3T	1
43	hex bolt	50108-5-0020-C0	M8x1.25x20L,8.8	4
44	anti-loose nut	55208-1-2008-CA	M8*1.25*8T	4
45	fixing nut	75000-6-2807-N0	M25*1.5*32*6T	2
46	allen bolt	54006-5-0010-F0	M6*1.0*10L,8.8	2
47	flat washer	55106-1-2820-FA	D28*D6.5*2T	2
48	C-key	75000-6-3107-01	8*7*20L	2
49	flat washer	55126-1-3420-FA	D34*D26*2.0T	1
50	crank axle welding set	747S0-3-2903-01		1
51	electric magnetic system	747S0-3-3102-01	D265*153*50 SKF bearing	1
52	system connect cable	820S0-6-3177-00	350L	1
53	flat washer	55106-1-1310-NA	D13*D6.5*1.0T	4
54	spring washer	55106-2-1013-NA	D10.5*D6.1*1.3T	4
55L	left cover	747B2-6-4501-B0	734.4*878.2*98.1	1
55R	right cover	747S0-6-4502-B0	734*878.2*105.2	1
56L	front decorative cover (left)	749S0-6-4523-B0	349.1*373.2*101.2	1
56R	front decorative cover (right)	749S0-6-4546-B0	349.1*373.2*98.2	1
57	front decoration cover	747S0-6-4523-B20	168.9*175.2*170.8	1
58	upper chain cover	749S0-6-4509-B0	455.7*175.2*96.1	1
59	upper decorative cover	749S0-6-4520-B0	639*313*175.6	1

60	round cover	747S0-6-4506-B0	D632.9*36.7	2
61	side cap	747S0-6-4582-C0	148*130.3*16.1	2
62	upper protective cover	734S0-6-4580-B0	170*147*125.5	1
63	front foot cap	749S0-6-3775-B0	784.9*144.6*142.4	1
64	cross screw	52842-2-0015-F0	ST4.2*15L	51
65	pin	71600-6-4586-60	D6*26.5*7.7	4
66	buffer	55308-4-0020-G9	D10.5*20L	2
67	movable axle	747S0-6-3771-N0	D25*180.5L	2
68	flat washer	55108-1-2520-FA	D25*D8.5*2T	2
69	buffer	739S0-6-1081-B0	D27*D8.2*2.5T	2
70	water bottle holder(front)(black)	749S0-6-2091-B0	189*154.2*67.9	1
71	water bottle holder(rear)(black)	749S0-6-2092-B0	203.1*189*157.4	1
72	water bottle holder	747S0-6-2074-B0	113*138.3*120.5	1
73	hex bolt	50108-5-0050-F3	M8*1.25*50L,8.8	8
74	curved washer	55108-3-2215-FA	D22xD8.5x1.5T	8
75	upper handle pulse cover	747S0-6-2517-B0	184.5*20.8*50	2
76	lower handle pulse cover	747S0-6-2518-B0	184.5*35.2*50	2
77	cross screw	54203-2-0030-F0	M3*0.5*30L	4
78	cross screw	54203-2-0012-F0	M3*0.5*12L	2
79	front handlebar protective cover	734S0-6-3780-B0	100*77.1*42	1
80	rear handlebar protective cover	734S0-6-3781-B0	97.2*75*42	1
81	front handlebar protective cover(black)	747S0-6-3780-B0	240.5*127.8*59	2
82	rear handlebar protective cover(black)	747S0-6-3781-B0	240.5*127.8*50	2
83	bearing	58006-6-1017-00	#6004ZZ	8
84L	front foot cover(left)	747S0-6-3775-B0	152.3*91.1*46.7	2
84R	front foot cover(right)	747S0-6-3776-B0	152.3*91.1*60	2
85	sleeve(2)	747S0-6-2788-00	D25.4*D20.2*44L	2
86	allen screw	50412-8-0070-F4	M12*1.75*70L 12.9	2
87	flat washer	55112-1-2425-FA	D24*D13.5*D2.5T	4
88	anti-loose nut	55212-1-2012-FA	M12*1.75*12T	2
89	front pedal axle cover	747S0-6-3880-B0	182.4*95.7*67.6	2
90	short axle	749S0-6-3890-00	D25*16L	2
91	pedal	58029-6-1147-B0	434.2*210.7*84	2

92	pedal pad	75000-6-3896-B0	379*168.5*5T	2
93	bearing	58006-6-1031-00	#2203-2RS	2
94	C-clip	55540-3-0018-D0	S-40(1.8T) D40	2
95	bushing	58002-6-1109-UC0	D25*D20*5.5L	4
96	cross screw	52606-2-0015-F0	M6*1*15L	8
97	upper computer cable	747S0-6-2572-00	300L	1
98	middle computer cable	734S0-6-2587-00	1000L	1
99	lower computer cable	749S0-6-2573-00	2050L	1
100	sensor cable	805S0-6-2576-00	500L	1
101	round magnet	174R4-6-2574-00	M02	1
102	quick key lower cable(1)	747S0-6-2544-00	850L	1
103	quick key lower cable(2)	747S0-6-2536-00	850L	1
104	electric delivery cable	749S0-6-2552-00	1800L	1
105	control board	747S0-6-2597-00	EMS7300-A04	1
106	power supplier	261D8-6-2411-00		1
107	socket	26100-6-2413-00		1
108	live wire	734S0-6-3480-00	150L	1
109	neutral wire	734S0-6-3479-00	150L	1
110	ground line	734S0-6-3486-00	200L	1
111	electric cable	26100-6-1775-02	1700L	1
112	back computer cover	747S0-6-2529-B0	337.6*225.5*58.4	1
113	screw	51004-2-0010-F0	ST4*1.41*10L	2
114	USB plug	747S0-6-4591-B0	18*10*5	1
115	Membrane keyboards(+)	749S0-6-2533-00	D39	1
116	Membrane keyboards(-)	749S0-6-2534-00	D39	1
117	computer set	749S0-2-2500-B0		1
118	quick key upper cable(1)	734S0-6-2542-00	400L	1
119	quick key upper cable(2)	734S0-6-2539-00	400L	1
120	allen spanner	58030-6-1031-N1	M6,8.8	1
121	spanner	58030-6-1039-C1	188*6.5T	1
122	allen spanner	58030-6-1033-N0	M10	1
123	hex bolt	50106-5-0015-C0	M6x1.0x15L, 8.8	2
124	Chain cover buckle	749S0-6-4574-B0	30*27*7.5	1

8.3 Exploded Drawing

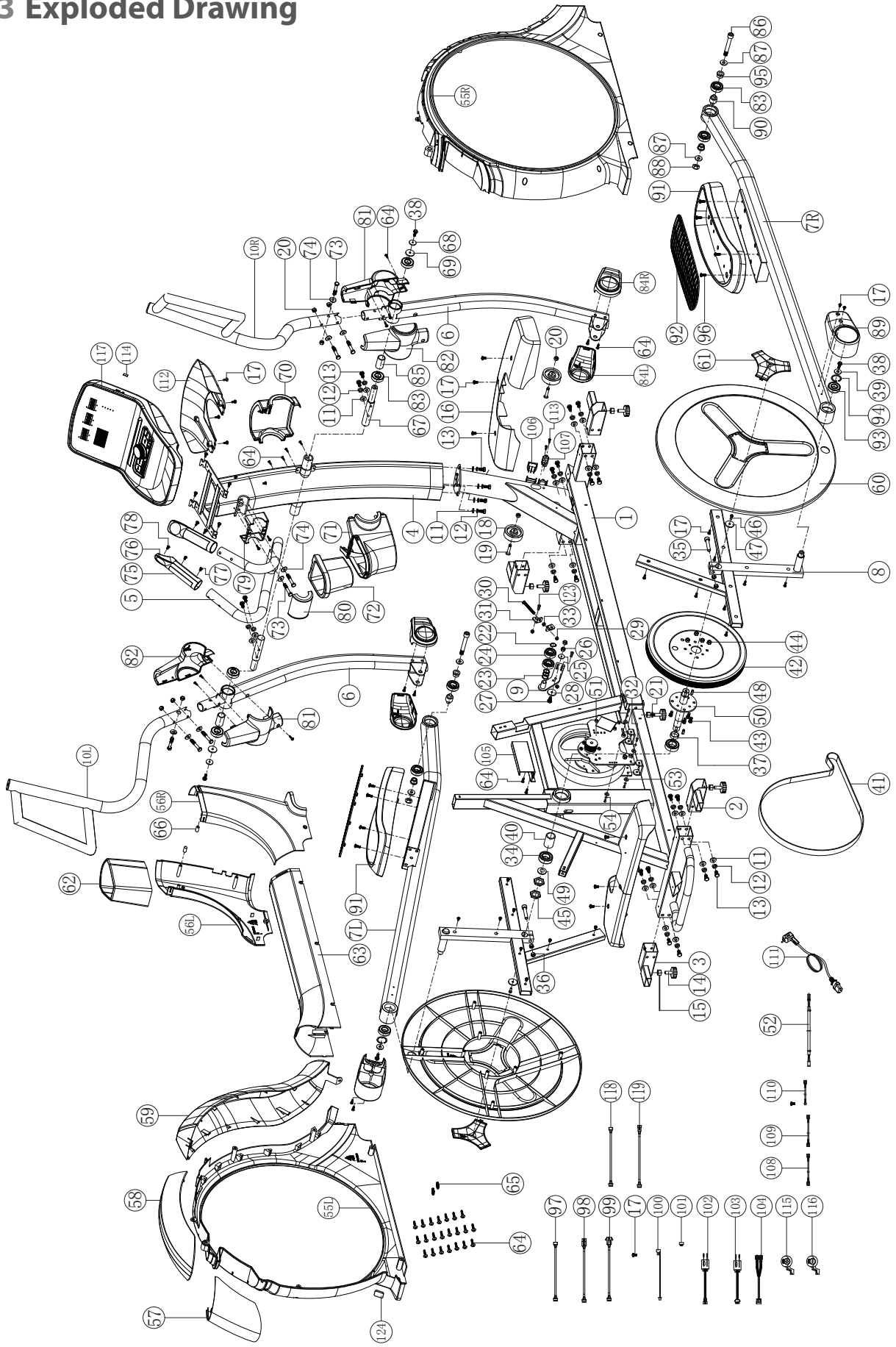

Training equipment from Taurus® is subject to strict quality control. However, if a fitness equipment purchased from us does not work perfectly, we take it very seriously and ask you to contact our customer service as indicated. We are happy to help you by phone via our service hotline.

Error Descriptions

Your fitness equipment is developed for long-term, high-quality training. However, should a problem arise, please first read the operating instructions. For further assistance, please contact your contract partner or call our service hotline. To ensure your problem is solved as quickly as possible, please describe the defect as exactly as possible.

In addition to the statutory warranty, we provide a warranty for every fitness equipment purchased from us according to the following provisions.

Your statutory rights are not affected.

Warranty

The warranty is the first/original buyer.

Warranty periods

The following warranty periods begin on delivery of the fitness equipment.

Warranty period

The warranty periods, shown on our web shop, begin on delivery of the fitness equipment. The respective warranty periods for your equipment can be found on its product website.

Repair Costs

According to our choice, there will either be a repair, a replacement of individual damaged parts or a complete replacement. Spare parts, that have to be mounted while assembling the equipment, have to be replaced by the warranty holder personally and are not a part of repair. After the expiration of the warranty period, the responsibility for parts costs, repair costs, installation costs and delivery costs lies with the warranty holder.

The terms of use are defined as follows:

- + Home use: solely for private use in private households up to 3 hours per day
- + Semi-professional use: up to 6 hours per day (e. g. rehabilitation centres, hotels, clubs, company gyms)
- + Professional use: more than 6 hours per day (e. g. commercial gyms)

Warranty Service

Within the warranty period, equipment which develops faults as a result of material or manufacturing defects, will be repaired or replaced at our discretion. Ownership of equipment or parts of equipment which have been replaced is transferred to us. The warranty period is not extended nor does a new warranty period begin following repair or replacement under the warranty.

Warranty Conditions

For the warranty to be valid, the following steps must be taken:

Please contact our customer service by email or phone. If the product under warranty has to be sent in for repair, the seller bears costs. After expiry of the warranty, the buyer bears the costs of transport and insurance. If the fault is covered by our warranty, you will receive a new or repaired equipment in return.

Warranty claims are invalid in case of damage resulting from:

- + misuse or improper handling
- + environmental influences (moisture, heat, electrical surge, dust, etc.)
- + failure to follow the current safety measures for the equipment
- + failure to follow the operating instructions
- + use of force (e. g. hitting, kicking, falling)
- + interventions which were not carried out by one of our authorized service centres
- + unauthorised repair attempts

Proof of Purchase and Serial Number

Please make sure that you are able to provide the appropriate receipt when claiming on your warranty. So that we can clearly identify the model of your equipment, and for the purposes of our quality control, you will need to give the serial number of your equipment, when contacting the service team. Where possible please have your serial number and your customer number ready when you call our service hotline. It will help us to deal with your request swiftly.

If you cannot find the serial number on your fitness equipment, our service team is at your disposal to offer further information.







































Service outside of the Warranty Period

We are also happy to issue an individual cost estimate if there is a problem with your fitness equipment after the warranty has expired, or in cases which do not fall under the terms of the warranty, e. g. normal wear and tear. Please contact our customer service team to find a quick and cost-effective solution to your problem. In such a case you will be responsible for the delivery costs.

Communication

Many problems can be solved just by speaking to us as your specialist supplier. We know how important it is to you as a user of the fitness equipment to have problems solved quickly and simply, so you can enjoy working out with minimal interruption. For that reason, we also want to resolve your queries quickly and in a straightforward manner. Thus, please always keep your customer number and the serial number of the faulty equipment handy.

10 CONTACT

DE	DK	FR
<p>TECHNIK</p> <p> +49 4621 4210-900</p> <p> +49 4621 4210-698</p> <p> technik@sport-tiedje.de</p> <p> Öffnungszeiten entnehmen Sie unserer Homepage.</p>	<p>TEKNIK OG SERVICE</p> <p> 80 90 16 50</p> <p>+49 4621 4210-945</p> <p> info@fitshop.dk</p> <p> Åbningstider kan findes på hjemmesiden.</p>	<p>TECHNIQUE & SERVICE</p> <p> +33 (0) 189 530984</p> <p>+49 4621 42 10 933</p> <p> info@fitshop.fr</p> <p> Vous trouverez les heures d'ouverture sur notre site Internet.</p>
<p>SERVICE</p> <p> 0800 20 20277 (kostenlos)</p> <p> 04621 4210 - 0</p> <p> info@sport-tiedje.de</p> <p> Öffnungszeiten entnehmen Sie unserer Homepage.</p>	<p>PL</p> <p>DZIAŁ TECHNICZNY I SERWIS</p> <p> 22 307 43 21</p> <p>+49 4621 42 10-948</p> <p> info@fitshop.pl</p> <p> Godziny otwarcia można znaleźć na stronie głównej.</p>	<p>BE</p> <p>TECHNIQUE & SERVICE</p> <p> 02 732 46 77</p> <p>+49 4621 4210 933</p> <p> info@fitshop.be</p> <p> Vous trouverez les heures d'ouverture sur notre site Internet.</p>
UK	NL	INT
<p>CUSTOMER CARE POWERHOUSE</p> <p> +44 141 737 2249 or +44 141 876 3972</p> <p> customercare@powerhouse-fitness.co.uk</p> <p> You can find the opening hours on our homepage.</p>	<p>TECHNISCHE DIENST & SERVICE</p> <p> +31 172 619961</p> <p> service@fitshop.nl</p> <p> De openingstijden vindt u op onze homepage.</p>	<p>TECHNICAL SUPPORT & SERVICE</p> <p> +49 4621 4210-944</p> <p> service-int@sport-tiedje.de</p> <p> You can find the opening hours on our homepage.</p>
ES	AT	CH
<p>TECNOLOGÍA Y SERVICIOS</p> <p> 911 238 029</p> <p> info@fitshop.es</p> <p> Consulta nuestro horario de apertura en la página web.</p>	<p>TECHNIK & SERVICE</p> <p> 0800 20 20277 (Freecall)</p> <p>+49 4621 42 10-0</p> <p> info@sport-tiedje.at</p> <p> Öffnungszeiten entnehmen Sie unserer Homepage.</p>	<p>TECHNIK & SERVICE</p> <p> 0800 202 027</p> <p>+49 4621 42 10-0</p> <p> info@fitshop.ch</p> <p> Öffnungszeiten entnehmen Sie unserer Homepage.</p>

Please find a detailed overview including address and opening hours for all stores of Powerhouse Fitness in the UK on the following website:

www.powerhouse-fitness.co.uk/storelocator

WE LIVE FITNESS

WEBSHOP AND SOCIAL MEDIA

The Sport-Tiedje Group is Europe's largest specialist for home fitness equipment with currently 70 stores and one of the world's most renowned online mail order companies for fitness equipment.

Powerhouse Fitness is part of the Sport-Tiedje Group. Private customers order via the 25 web shops in the respective national language or have their desired equipment assembled on site. In addition, the company supplies fitness studios, hotels, sports clubs, companies and physio practices with professional equipment for endurance and strength training.

The Sport-Tiedje group offers a wide range of fitness equipment from renowned manufacturers, high-quality in-house developments and comprehensive services, such as a build-up service and sports scientific advice before and after the purchase. The company employs numerous sports scientists, fitness trainers and competitive athletes.

Visit us also on our social media platforms or our blog!



<http://www.powerhouse-fitness.co.uk/>
www.powerhouse-fitness.co.uk/blog/



<https://www.facebook.com/powerhousefitness.co.uk>



www.instagram.com/powerhousefitness_uk/



www.youtube.com/user/PHFTV/

TAURUS

 cardiostrong

BODYCRAFT

 **BodyMax**
PERFORMANCE FITNESS EQUIPMENT

Notes

Notes

TAURUS®

Crosstrainer X9.9