

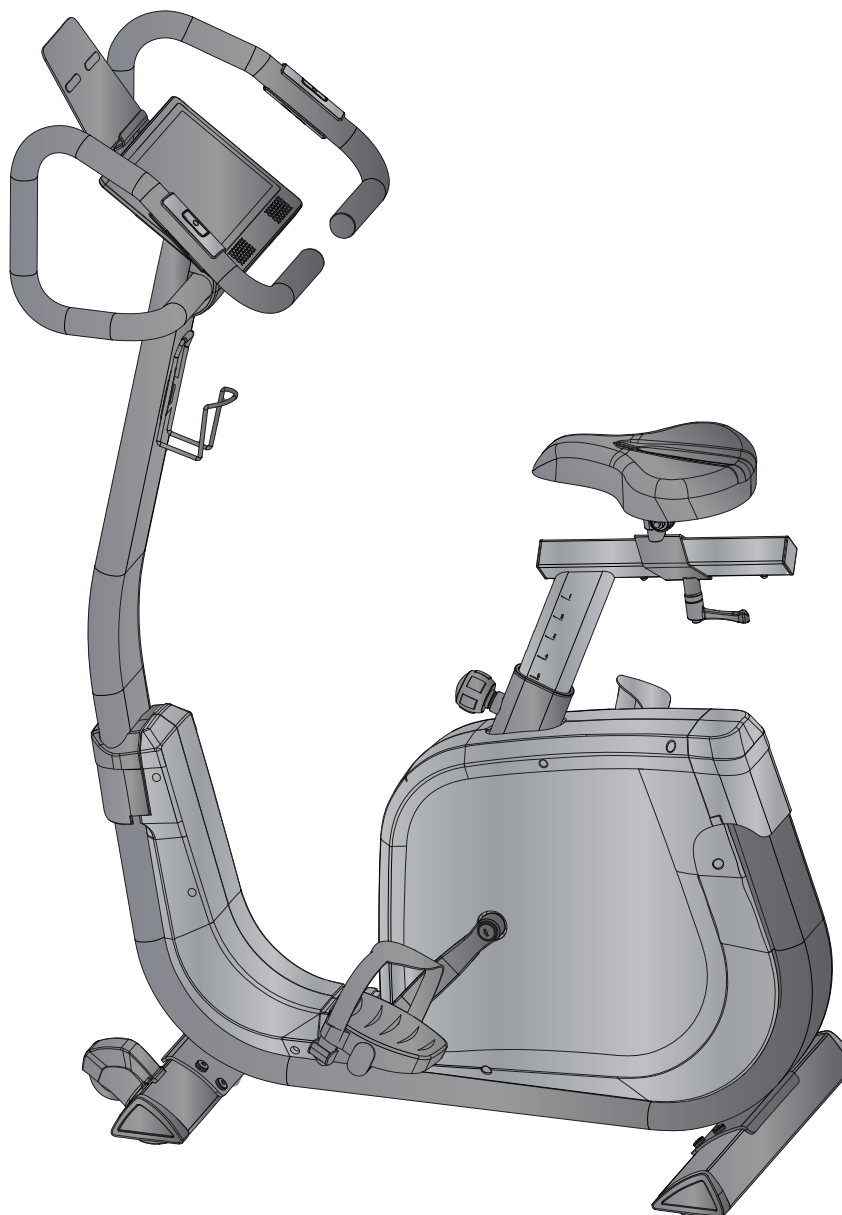

## Assembly and Operating Instructions



max. 150 kg



~ 30-60 Min.



48 kg  
L 108 | W 56 | H 134

FSUKCSTBX70iT.01.03

SKU: CST-BX70i-T

Exercise Bike **BX70i Touch**



# Content

<b>1</b>	<b>GENERAL INFORMATION</b>	<b>8</b>
1.1	Technical Data	8
1.2	Personal Safety	9
1.3	Electrical Safety	10
1.4	Set-Up Place	11
<b>2</b>	<b>ASSEMBLY</b>	<b>12</b>
2.1	General Instructions	12
2.2	Scope of Delivery	13
2.3	Assembly	15
<b>3</b>	<b>OPERATING INSTRUCTIONS</b>	<b>22</b>
3.1	Console Display	22
3.2	Button Functions	23
3.3	Further Functions	24
3.4	Programmes	25
3.4.1	Quick-Start Programme/Target Programme	26
3.4.2	Pre-set Programmes	27
3.4.3	Interval Programme	28
3.4.4	Heart Rate Controlled Programmes	29
3.4.5	Watt Programme	31
3.4.6	Virtual Training Routes	32
3.5	Multimedia and Software Updates	35
3.6	Wireless Connection and Fitness Apps	36
<b>4</b>	<b>STORAGE AND TRANSPORT</b>	<b>38</b>
4.1	General Instructions	38
4.2	Transportation Wheels	38
<b>5</b>	<b>TROUBLESHOOTING, CARE AND MAINTENANCE</b>	<b>38</b>
5.1	General Instructions	38
5.2	Faults and Fault Diagnosis	39
5.3	Error Codes and Troubleshooting	39
5.4	Maintenance and Inspection Calendar	40
<b>6</b>	<b>DISPOSAL</b>	<b>40</b>
<b>7</b>	<b>RECOMMENDED ACCESSORIES</b>	<b>41</b>

<b>8</b>	<b>ORDERING SPARE PARTS</b>	<b>42</b>
8.1	Serial Number and Model Name	42
8.2	Parts List	43
8.3	Exploded Drawing	46
<b>9</b>	<b>WARRANTY</b>	<b>47</b>
<b>10</b>	<b>CONTACT</b>	<b>49</b>

**Dear customer,**

thank you for choosing fitness equipment from cardiostrong®. cardiostrong offers high-quality home fitness equipment that is optimally adapted to the conditions at home. Train at home no matter what the weather or time of the day. cardiostrong fitness equipment offers training programmes and a variety of equipment for all training levels and all training goals. Further information can be found at [www.fitshop.com](http://www.fitshop.com) or [www.cardiostrong.de](http://www.cardiostrong.de). We hope you enjoy your training!

Further information can be found at [www.fitshop.co.uk](http://www.fitshop.co.uk).

**Intended Use**

The equipment may only be used for its intended purpose.

The equipment is suitable for home use and semi-professional use (e.g. hospitals, clubs, hotels, schools, etc.). The equipment is not suitable for commercial or professional use (e.g. fitness studio).

**Legal Notice**

Fitshop GmbH  
Europe's No. 1 for home fitness

International Headquarters  
Flensburger Straße 55  
24837 Schleswig  
Germany

Management:  
Christian Grau  
Sebastian Campmann  
Dr. Bernhard Schenkel  
No. HRB 1000 SL  
Local Court Flensburg  
European VAT Number: DE813211547

**Disclaimer**

© cardiostrong is a registered brand of the company Fitshop GmbH. All rights reserved. Any use of this trademark without the explicit written permission of Fitshop is prohibited.

Product and manual are subject to change. Technical data can be changed without advance notice.

# **FITSHOP**

Europe's No.1 for Home Fitness

## ABOUT THIS MANUAL

Please carefully read the entire manual before installation and first use. The manual will help you to quickly set up the system and explains how to safely use it. Make sure that all persons exercising with the equipment (especially children and persons with physical, sensory, mental or motor disabilities) are informed about this manual and its contents in advance. In case of doubt, responsible persons must supervise the use of the equipment.



Due to ongoing changes and software optimisations, the manual may have to be updated. If you notice any discrepancies during assembly or use, please refer to the manual uploaded to the webshop. The latest manual is always available there.

This equipment has been manufactured according to the latest safety knowledge. As far as possible, potential safety hazards which could cause injury have been eliminated. Make sure to carefully follow the instructions and that all parts are securely in place. If required, read through the instructions again to correct any mistakes.

Training devices must be classified according to accuracy and use. Accuracy classes are only applicable to devices that display training data.

### Accuracy classes

Class A: high accuracy.

Class B: medium accuracy.

Class C: low accuracy.

The use classes explain the intended use of the training device.

### Use classes

**Class S** (studio): professional and/or commercial use.

These training devices are intended for the use in training rooms of facilities such as sports clubs, school facilities, hotels, clubs and studios whose access and supervision is specifically regulated by the owner (person with legal responsibility).

**Class H** (home use): use at home.

These stationary training devices are intended for the use in private homes where access to the training device is regulated by the owner (person with legal responsibility).

Please pay close attention to the safety and maintenance instructions given here. The contract partner cannot be held liable for damage to health, accidents or damage to the equipment when it is not used in accordance with these instructions.

The following safety instructions may appear in this manual:

► **ATTENTION**

This notice indicates potentially hazardous situations which, if not avoided, may result in property damage.

⚠ **CAUTION**

This notice indicates potentially hazardous situations which, if not avoided, may result in slight or minor injuries!

⚠ **WARNING**

This notice indicates potentially hazardous situations which, if not avoided, may result in death or serious injuries!

⚠ **DANGER**

This notice indicates potentially hazardous situations which, if not avoided, will result in death or serious injuries!

ⓘ **NOTICE**

This notice indicates further useful information.

Retain these instructions in a safe place for future reference, maintenance or when ordering replacement parts.

## 1.1 Technical Data

### TFTdisplay of

- + Speed in km/h
- + Rotations per minute
- + Training time in min
- + Training distance
- + Calorie consumption in kcal
- + Heart rate (when using the chest strap)
- + Watt

Resistance system: electromagnetic induction brake  
Resistance level: 32

Wattage  
Min. and max. Watt at 60 RPM: 26-270 W  
Min. and max. Watt at 100 RPM: 48-457 W  
Adjustable range in the Watt programme: 20-350 W

Total number of training programs: 20  
Quick start programmes: 1  
Target programmes: 1  
Pre-set programmes: 12  
Interval programmes: 1  
Heart rate controlled programmes: 4  
Watt controlled programmes: 1

Flywheel mass: 10 kg  
Transmission: 1 : 8.6  
Pedal arm length: 17 cm

### Weight and dimensions

Article weight (gross, including packaging): 52,4 kg  
Article weight (net, without packaging): 47,5 kg

Packaging dimensions (L x W x H): approximately 100 cm x 31 cm x 70 cm  
Set-up dimensions (L x W x H): approximately 96 cm x 56cm x 143 cm  
Maximum user weight: 150 kg/330 lbs

Use class: S



## 1.2 Personal Safety

### DANGER

- + Before you start using the equipment, you should consult your physician that this type of exercise is suitable for you from a health perspective. Particularly affected are persons who: have a hereditary disposition to high blood pressure or heart disease, are over the age of 45, smoke, have high cholesterol values, are overweight and/or have not exercised regularly in the past year. If you are under medical treatment that affects your heart rate, medical advice is absolutely essential.
- + Note that excessive training can seriously endanger your health. Please also note that heart rate monitoring systems can be inaccurate. If you notice any signs of weakness, nausea, dizziness, pain, shortness of breath, or other abnormal symptoms, stop exercising immediately and seek advice from your doctor if necessary.
- + The owner must communicate all warnings and instructions to the user.

### WARNING

- + This equipment may not be used by children under the age of 14.
- + Children should not be allowed unsupervised access to the equipment.
- + Persons with disabilities must have a medical license and must be under strict observation when using the equipment.
- + The equipment is strictly for use by one person at a time.
- + If your equipment provides a safety key, the clip of the safety key must be attached to your clothing before starting your training. In the event of a fall, the EMERGENCY STOP of the equipment can be initiated.
- + There is a risk of injury from spinning pedals and/or an exposed flywheel in the absence of a freewheel. Never get on or off the equipment when the pedals or the flywheel are still moving. Always make sure that the pedals and the flywheel have come to a complete stop.
- + Support yourself with at least one hand on the handlebar when getting on and off the equipment. Only dismount from the equipment when the pedals have come to a complete stop.
- + Keep your hands, feet and other body parts, hair, clothing, jewellery and other objects well clear of moving parts.
- + During use, wear suitable sports clothing rather than loose or baggy clothing. When wearing sports shoes, make sure they have suitable soles, preferably made of rubber or other non-slip materials. Shoes with heels, leather soles, studs or spikes are unsuitable. Never exercise barefoot.

### CAUTION

- + If your equipment needs to be connected to the power supply with a mains cable, make sure that the cable is not a potential tripping hazard.
- + Make sure that nobody is within the range of motion of the equipment during training so as not to endanger you or other persons.
- + Always tighten the pedal strap before you start training to prevent your feet from slipping.

**CAUTION**

- + Be aware that if adjustment devices are left protruding, they may impede the user's movement.

**ATTENTION**

- + Do not insert any objects of any kind into the openings of the device.
- + To protect the equipment from use by unauthorised third parties, always remove the power cable when not in use and store it in a safe place that is inaccessible to unauthorised persons (e.g. children).
- + Class B and C crank training equipment is not suitable for high accuracy purposes.

## 1.3 Electrical Safety

**DANGER**

- + In order to reduce the risk of an electric shock, always unplug the equipment from the mains socket immediately after your workout, before assembly or dismantling, and before maintenance or cleaning. Do not pull on the cable.

**WARNING**

- + Do not leave the equipment unattended while the mains cable is plugged into the mains socket. During your absence, the mains cable must be removed from the mains socket to prevent improper use by third parties or children.
- + If the mains cable or plug is damaged or defective, contact your contract partner. Until repair, the equipment must not be used.

**ATTENTION**

- + The equipment requires a mains connection of 220-230 V with 50 Hz mains voltage.
- + The equipment may only be connected directly to an earthed socket using the supplied mains cable. Extension cables must conform to VDE guidelines. Always completely unwind the mains cable.
- + The socket must be protected by a fuse with a minimum fuse rating of "16 A, slow blow".
- + Do not make any changes to the mains cable or the mains plug.
- + Keep the mains cable away from water, heat, oil and sharp edges. Do not route the mains cable underneath the equipment or under a carpet or rug, and do not place any objects on top of it.
- + If your purchased item is equipped with a TFT console, software updates must be carried out regularly. Follow the instructions on the console to perform the update(s).
- + The software systems on gym equipment with TFT consoles are set up only for the pre-installed apps. Do not install any additional apps.

**NOTICE**

- + The pre-installed apps on TFT consoles are produced and provided by external manufacturers. Fitshop does not take any responsibility for the availability, functionality or contents of these apps.

## 1.4 Set-Up Place



### **WARNING**

- + Do not place the equipment in main corridors or escape routes.



### **CAUTION**

- + Choose a location in which to place the equipment such that there is enough free space/clearance to the front, the rear and to the sides of the equipment.
- + The training room should be well ventilated during training and not be exposed to any draughts.
- + Choose the place in which to set up the equipment such that there is enough free space/clearance to the front, the rear and to the sides of the equipment.
- + The free area in the direction from which the exercise equipment is accessed must be at least 0.6 m larger than the exercise area.
- + The set-up and mounting surface of the equipment should be flat, loadable and solid.



### **ATTENTION**

- + The device may only be used in one building, in sufficiently tempered and dry rooms (ambient temperatures between 10°C and 35°C). The equipment should not be used outdoors or in rooms with high humidity (over 70%) like swimming pools.
- + A floor protective mat/equipment underlay can help to protect high-quality floor coverings (parquet, laminate, cork, carpets) from dents and sweat and can help to level out slight unevenness.
- + For Class S equipment, the exercise equipment may only be used in areas where access, supervision and control are specifically regulated by the owner.

### 2.1 General Instructions



#### **DANGER**

- + Do not leave any tools, packaging materials such as foils or small parts lying around, as otherwise there is a danger of suffocation for children. Keep children away from the equipment during assembly.



#### **WARNING**

- + Pay attention to the instructions attached to the equipment in order to reduce the risk of injuries.



#### **CAUTION**

- + Ensure to have sufficient room for movement in each direction during assembly.
- + The assembly of the equipment must be carried out by at least two adults. If in doubt, seek the help of a third technically skilled person.



#### **ATTENTION**

- + To prevent damage to the equipment and the floor, assemble the equipment on a mat or packaging board.



#### **NOTICE**

- + In order to make the assembly as simple as possible, some screws and nuts to be used can already be pre-assembled.
- + Ideally, assemble the equipment at its later set-up place.

## 2.2 Scope of Delivery

The scope of delivery consist of the following parts. At the beginning, check whether all parts and tools belonging to the device are included in the scope of delivery and whether damage has occurred. In the event of complaints, the contractual partner must be contacted directly.



### **CAUTION**

If parts of the scope of delivery are missing or damaged, the assembly must not be carried out.

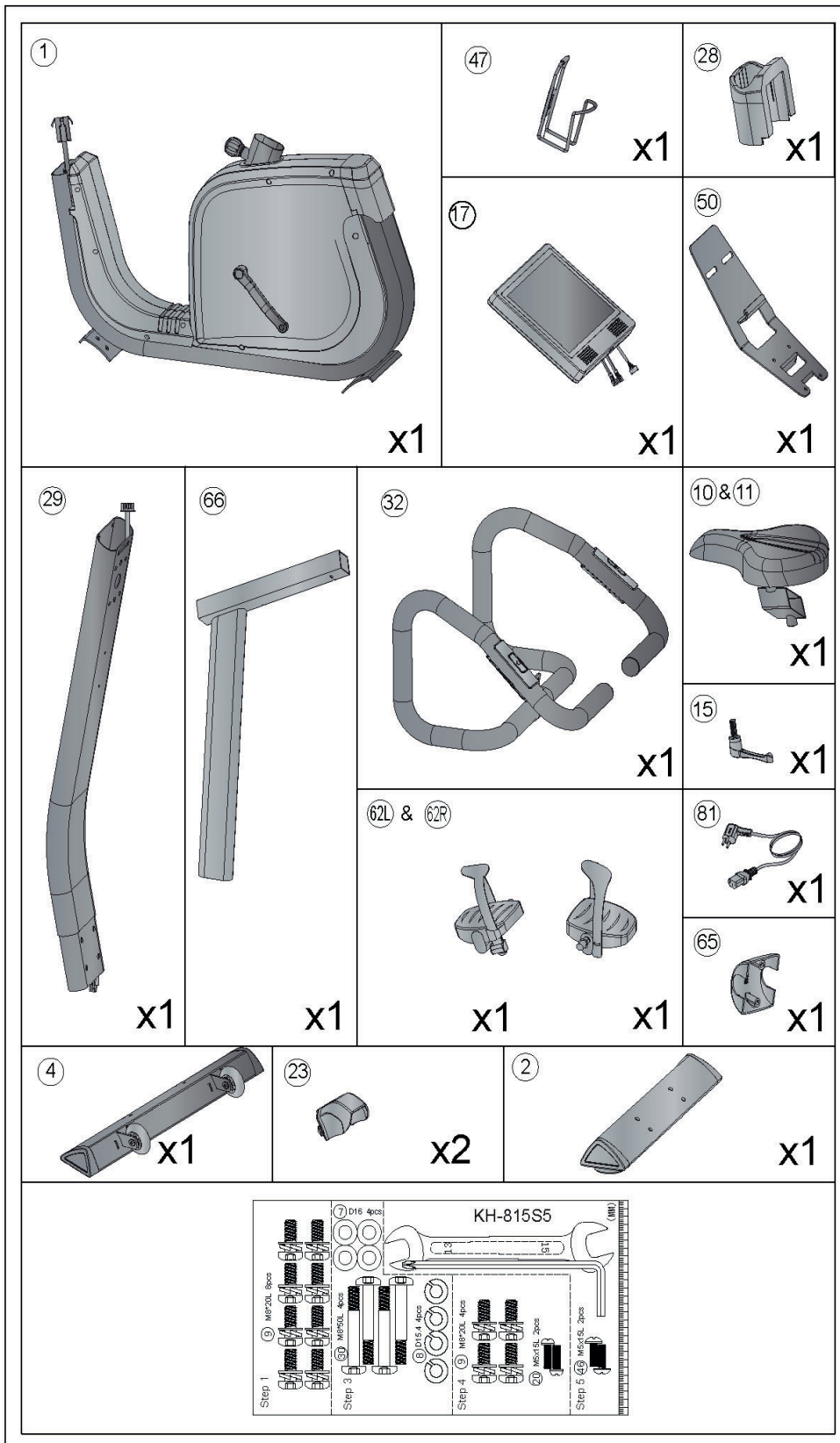

## 2.3 Assembly

Before assembly, take a close look at the individual assembly steps shown and carry out the assembly in the order given.

### ① NOTICE

- + First loosely screw all parts together and check that they fit properly. Tighten the screws using the tool only when you are instructed to do so.
- + If you have difficulty recognising the graphics, we recommend that you open and/or download the PDF instructions stored in the webshop on your end device (e.g. smartphone, tablet or PC). There you have the option of zooming in closer. Please note that the Adobe Acrobat Reader programme must be installed on your end device in order to open the file.

### Step 1: Assembling the stabilizers

1. Mount the front stabilizer (4) and the rear stabilizer (2) to the main frame (1) with screw (9).
2. Turn the screws under the foot cap to set the appropriate height. Tighten the screws. Mount the cover of the wheel (23).

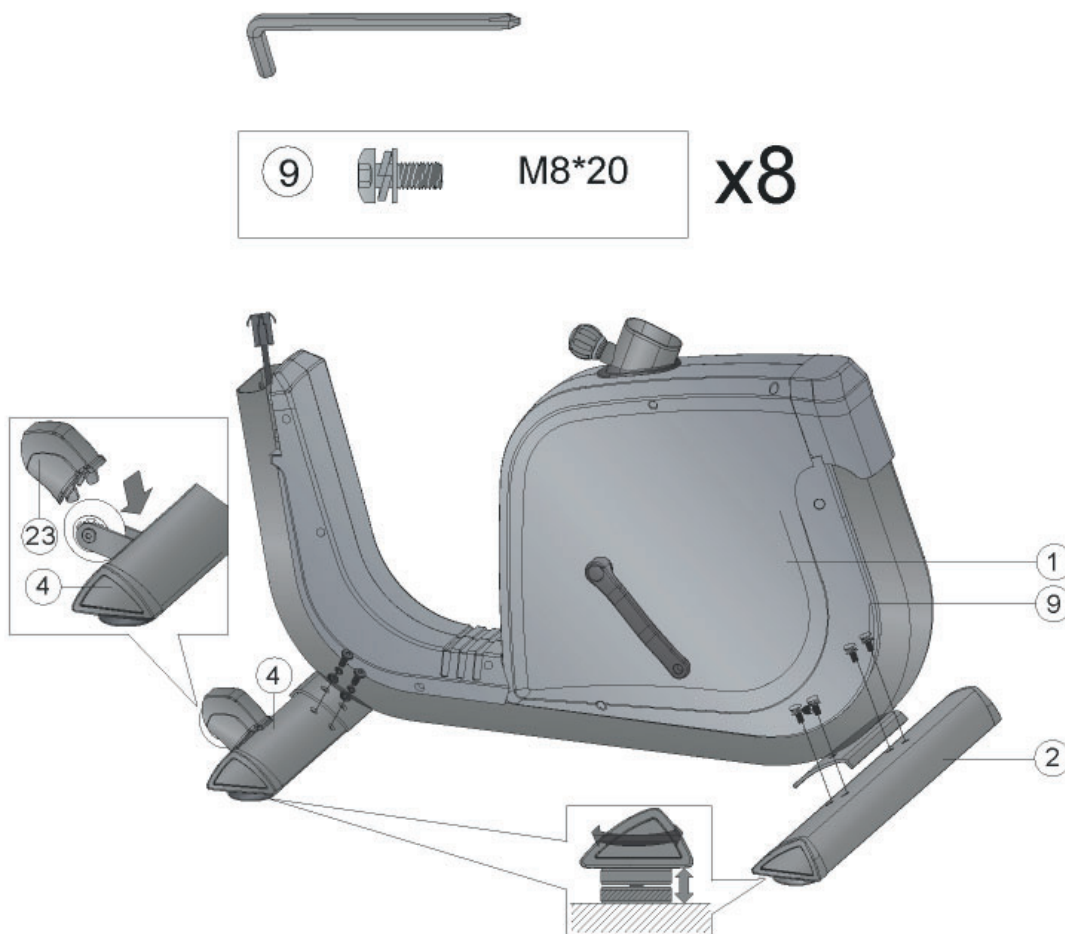

## Step 2: Assembly of the saddle

1. Mount the seat (10) on the adjustment tube of the seat adjustment tube (11).
2. Mount the seat adjustment tube (11) on the seat post (66) with a screw (16) and the quick-release knob (15).

### NOTICE

The seat can be adjusted in vertical and horizontal direction, see fig. a and b.

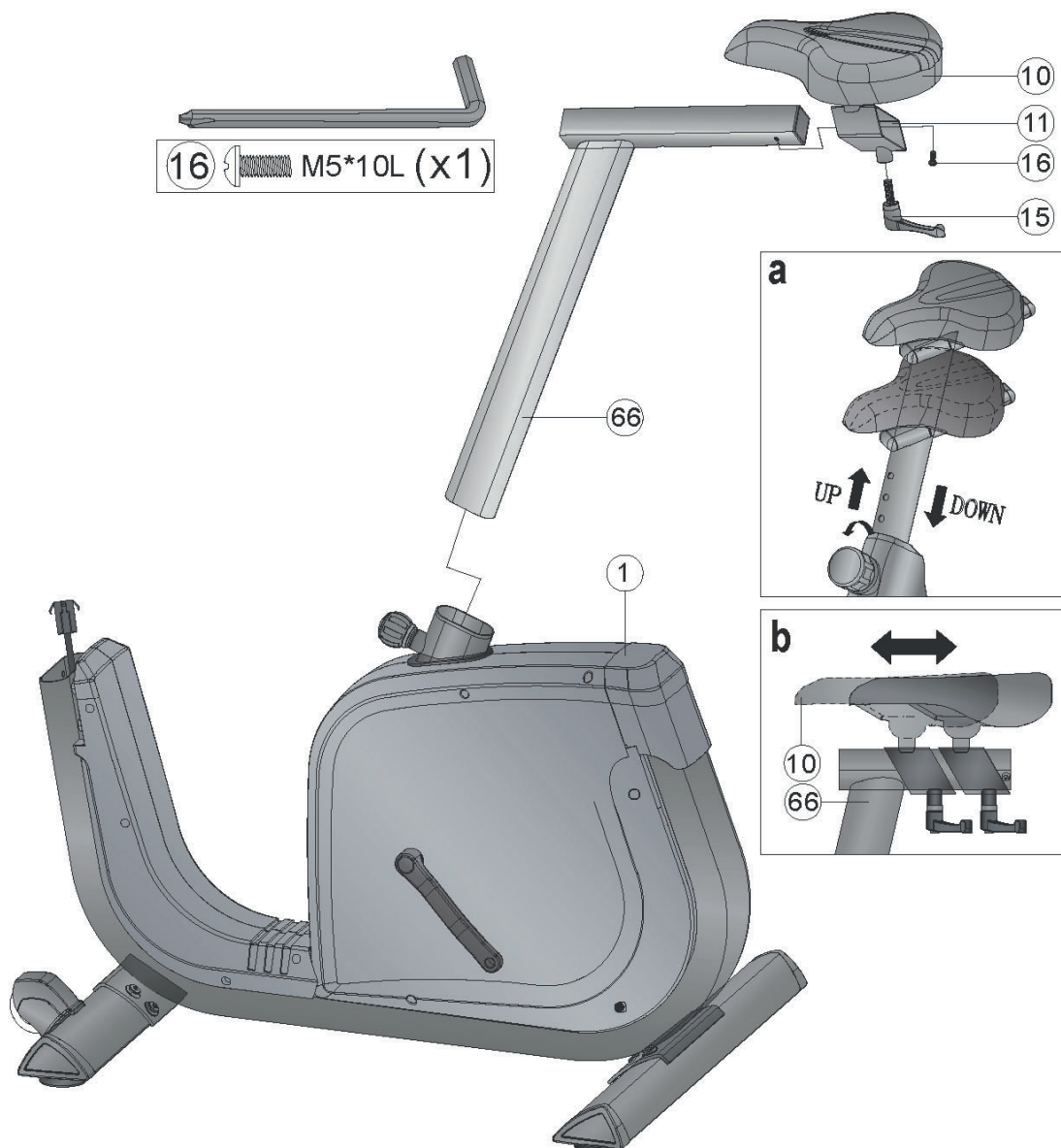



### Step 3: Assembly of the handlebar post

1. Connect the upper computer cable of the handlebar post (72) to the lower computer cable of the main frame (73).

► **ATTENTION**

Be careful not to pinch the cables during the following step.

2. Slide the protective cover (28) onto the handlebar post (29).
3. Secure the handlebar post (29) with four bolts (30), four spring washers (8) and four flat washers (7).

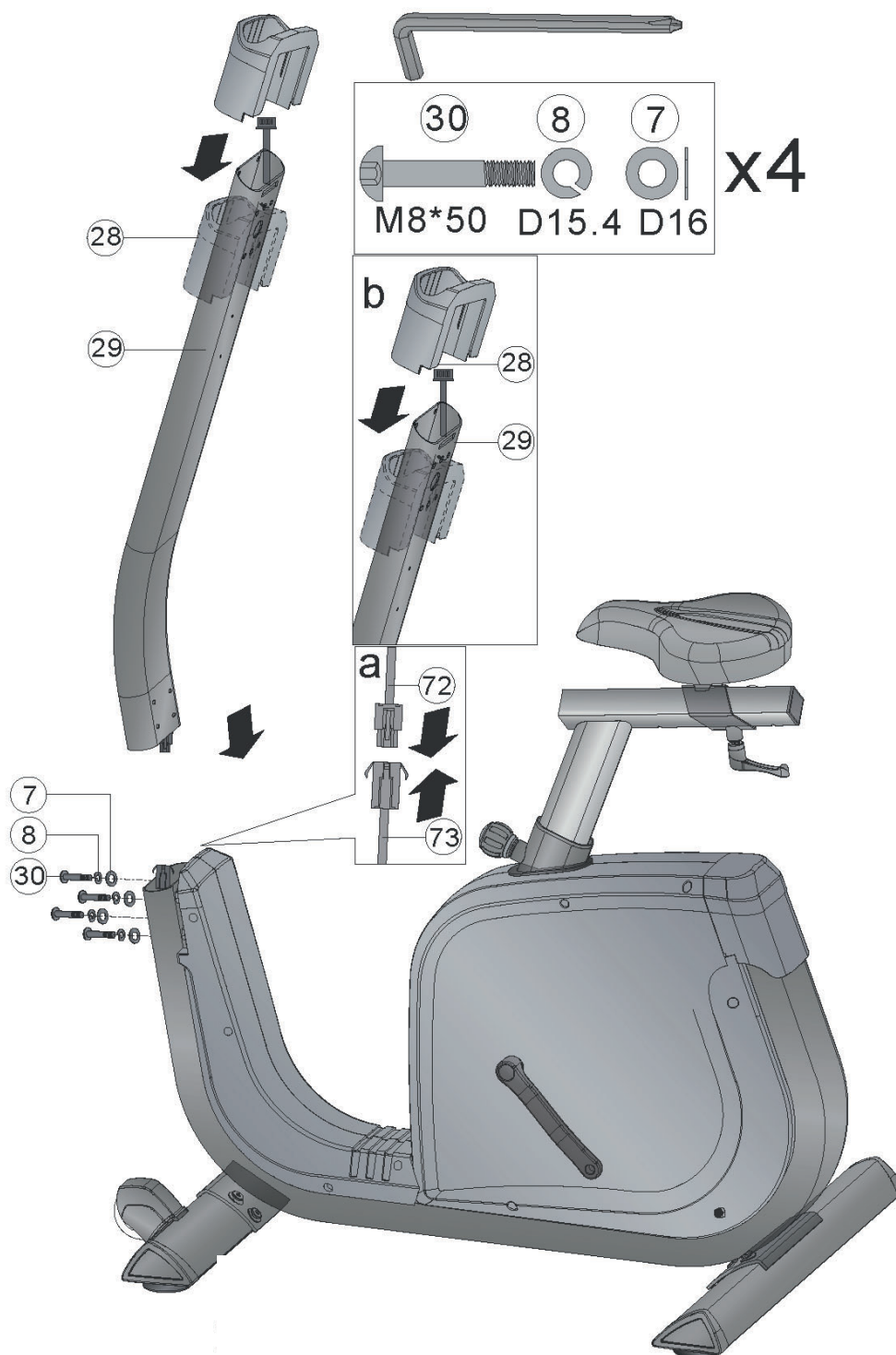

#### Step 4: Assembly of the handlebar

1. Guide the two pulse cables of the handlebar (68) through the opening provided for this purpose in the handlebar post (29).

► **ATTENTION**

Be careful not to pinch the cables during the following step.

2. Mount the fixed handlebar (32) on the handlebar post (29) with four bolts (9) (fig. a - c).
3. Mount the protective cover (65) with two bolts (20).
4. Remove and dispose of the fuse (fig. d)

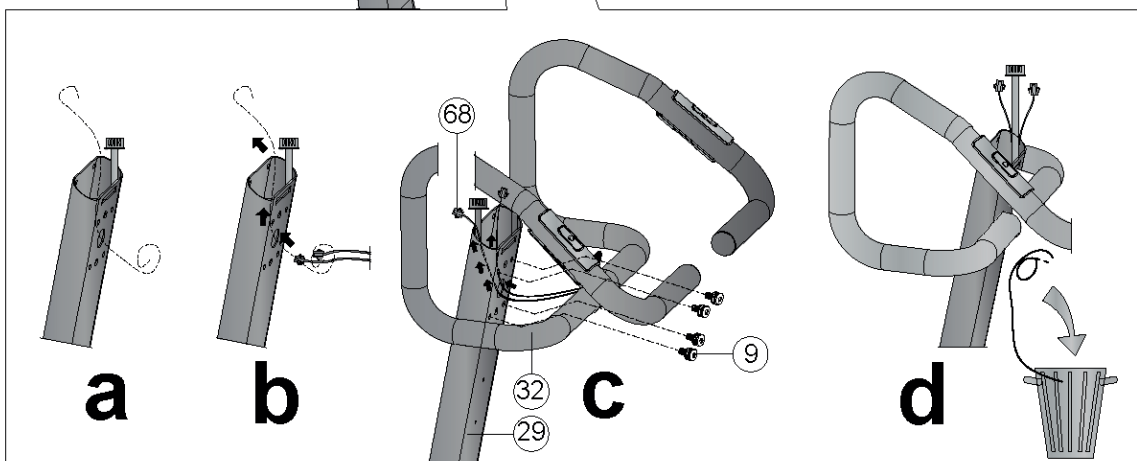
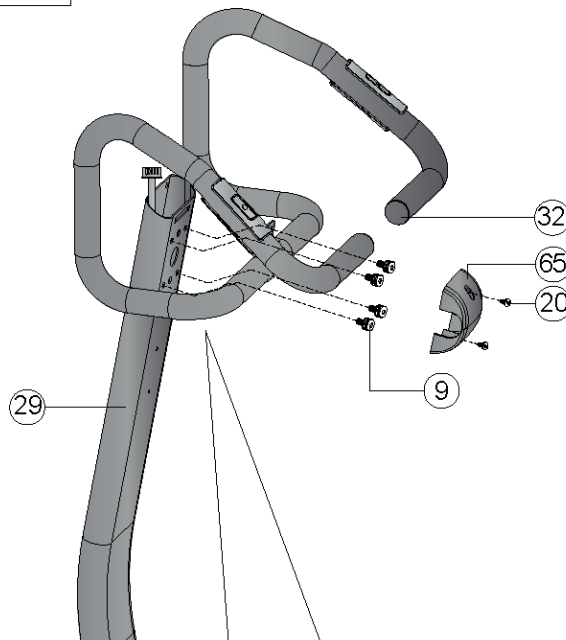
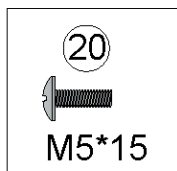
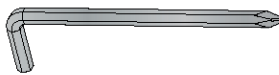

## Step 5: Assembly of the console

1. Guide the hand pulse and computer cables of the console (68 & 72) through the opening provided for this purpose in the fixing plate (50).

### ► ATTENTION

Be careful not to pinch the cables during the following steps.

2. Mount the console (17) to the fixing plate (50) with four bolts (46) (fig. a).
3. Connect the hand pulse and computer cables of the console (68 & 72) to their corresponding counterparts of the handlebar post and handlebar (29 & 68) (fig. b).
4. Mount the fixing plate (50) to the handlebar post (29) with two bolts (46) (fig. c).
5. Mount the bottle holder (47) to the handlebar post (29) with two bolts (46).

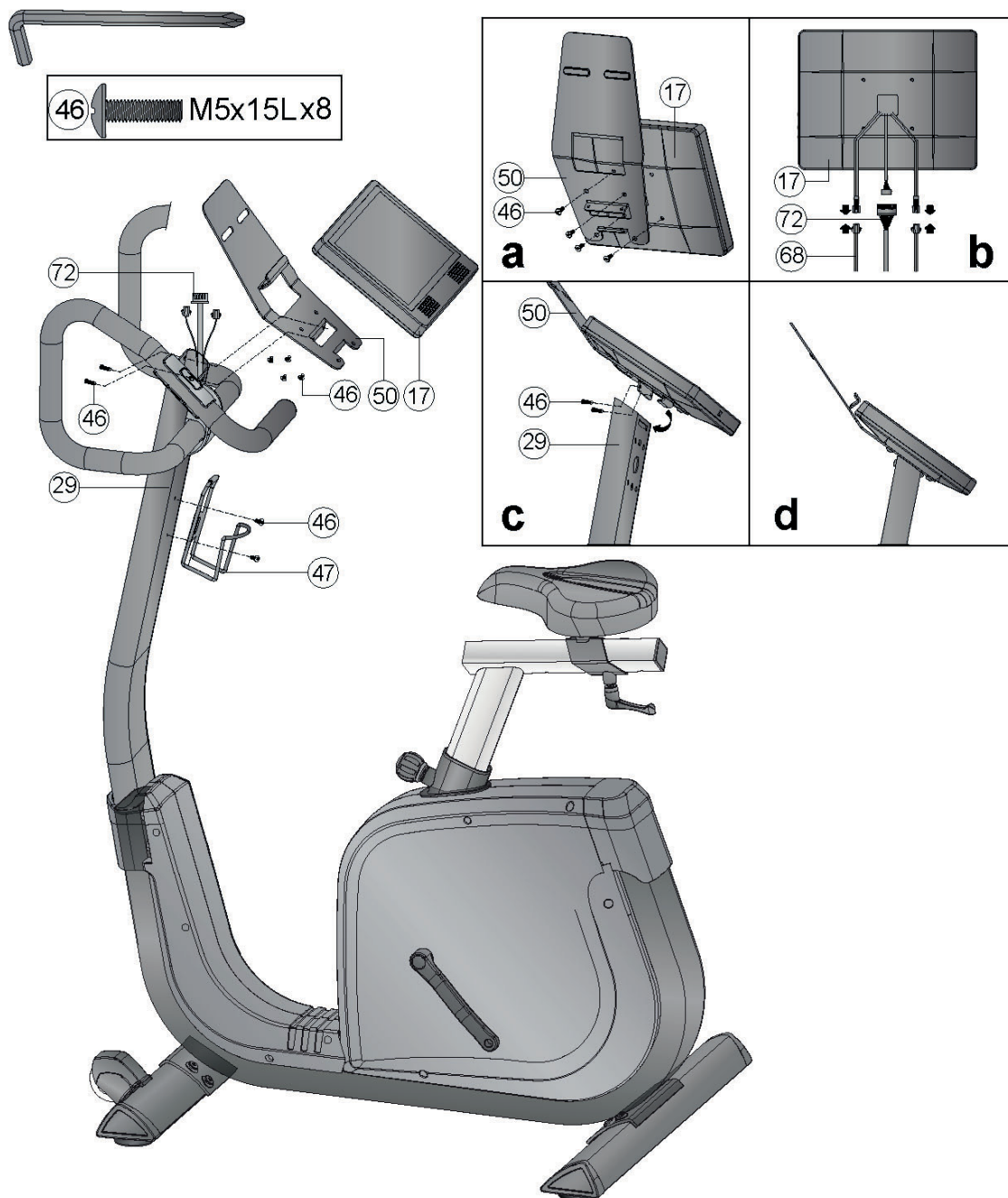

## Step 6: Assembly of the pedals

### ⓘ NOTICE

The pedals and pedal straps are marked accordingly (left/right).

1. Attach the pedal straps to the pedals (62R & 62L).

### ▶ CAUTION

Make sure that the pedals are screwed in completely.

2. Fit the right pedal (62R) to the right crank (35R) by turning clockwise.
3. Mount the left pedal (62L) on the left crank (35L) by turning it anticlockwise.
4. Now tighten all screw connections.

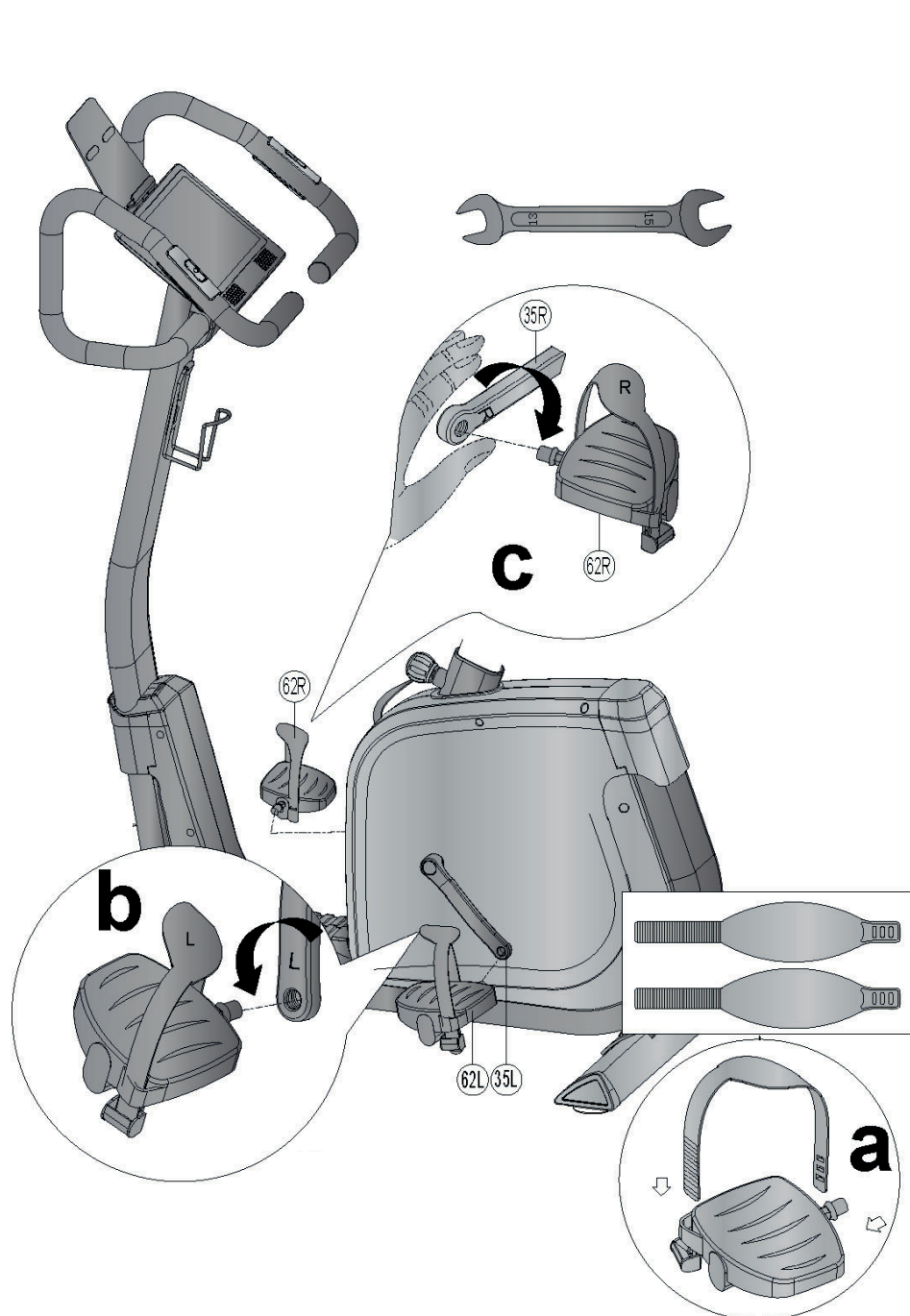

## Step 6: Connecting the equipment to the mains supply

### ► ATTENTION

The equipment must not be connected to a multiple socket, otherwise it cannot be guaranteed that the equipment will be supplied with sufficient power. Technical errors can result.

Plug the power plug into a wall outlet that complies with the instructions in the chapter on electrical safety.

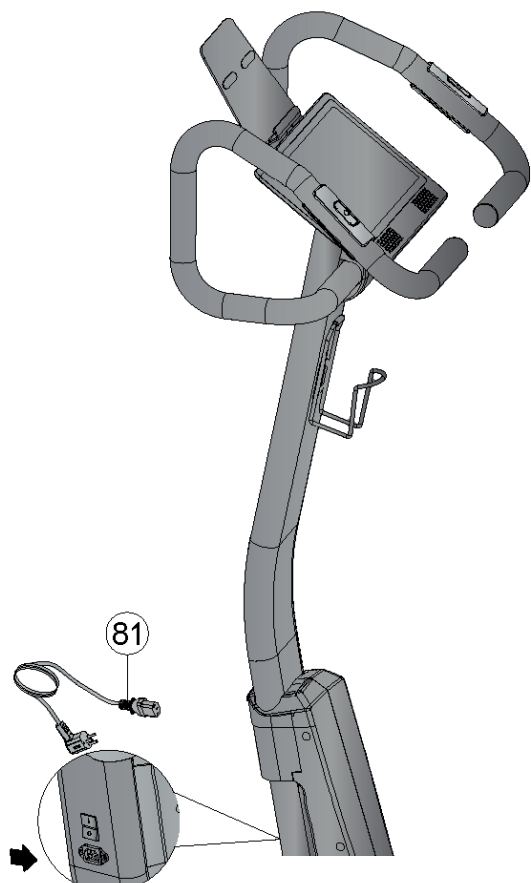

## Correctly Getting On and Off

1. To get on, grip the handles with both hands and first step onto the left pedal with your left foot or onto the right pedal with your right foot and then place your foot onto the other pedal.
2. To get off, grip the handles with both hands and place one foot next to the equipment and then the other foot.

## 3 OPERATING INSTRUCTIONS

### ① NOTICE

- + Familiarise yourself with all the functions and setting options of the device before starting training. Have the proper use of this product explained to you by a specialist.
- + Always start your training with low intensity and increase evenly and gently. End your training with a cool-down phase. If you are unsure, please consult your physician.

### 3.1 Console Display

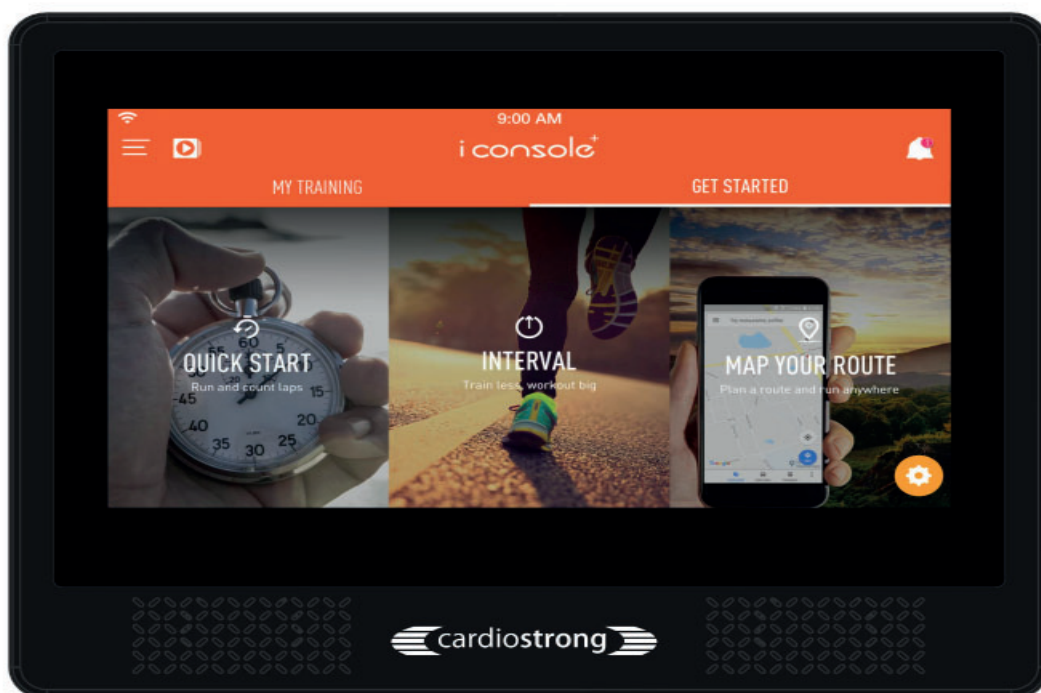





<b>TIME</b>	+ Display of the training time + Display range 0:00 - 99:59:59
<b>SPEED</b>	+ Display of the current speed
<b>DISTANCE</b>	+ Display of the training distance + Display range 0 - 999.9 km or mi
<b>CALORIES</b>	+ Display of the calorie consumption + Display range 0 - 9999 Cal
<b>Heart Rate</b>	+ Display of the current heart rate + Display of the heart rate + Display range 0 - 230
<b>WATT</b>	+ Display of the Watt value + Display range 0-9999
<b>HR Zone</b>	+ Display of the heart rate zones + Display range very light, light, moderate, hard, maximum
<b>RPM</b>	+ Display of the current revolutions per minute (RPM) + Display range 0 - 999
<b>BAI</b>	+ Display of the BAI consumption (Body Activity Intelligence) + Display range 0 - 999  <b>ⓘ NOTICE</b> Body Activity Intelligence (BAI) is a universal and consistent metric that applies to all ages and genders. It evaluates whether your physical activity and training are sufficient for improving your overall health and physical condition.

## 3.2 Button Functions

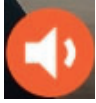
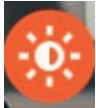
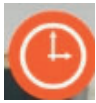
<b>Start/Pause:</b>	+ Tap to start and/or pause the training
<b>Stop</b>	+ Tap to stop the training
<b>Up</b>	+ Tap to increase a value
<b>Down</b>	+ Tap to decrease a value

### 3.3 Further Functions

	<b>Settings</b>	Here you will find all setting options.
	<b>Volume</b>	Here you can adjust the volume.
	<b>Brightness</b>	Here you can adjust the brightness.
	<b>Timezone</b>	Here you can adjust the date or the current time zone.
	<b>Wifi</b>	Here you can connect the console to a wifi network.
	<b>Heart Rate</b>	Here you can connect the console to a chest strap.
	<b>Multimedia</b>	Here you can access different media: Netflix, Youtube, Spotify, Kinomap, Chrome, Facebook, Twitter, Instagram, Amazon Prime Video.



## 3.4 Programmes

There are a variety of programmes available to you. These include

- + Quick Start programme: 1
- + Target programme: 1
- + Pre-set programmes: 12
- + Interval programme: 1
- + Heart rate programmes: 4
- + Watt programme: 1

You can also set your own virtual training routes via Google Maps.

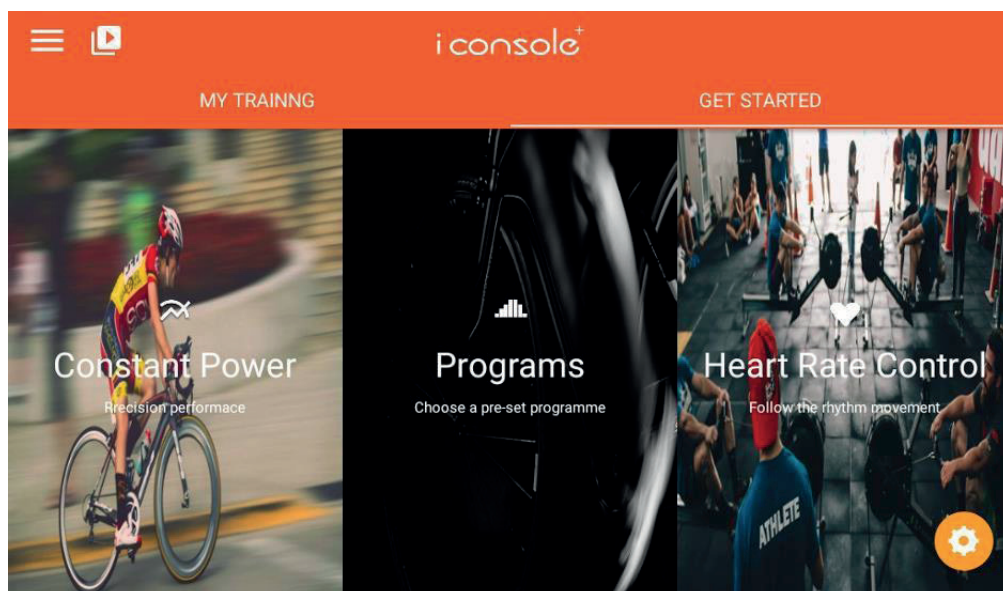
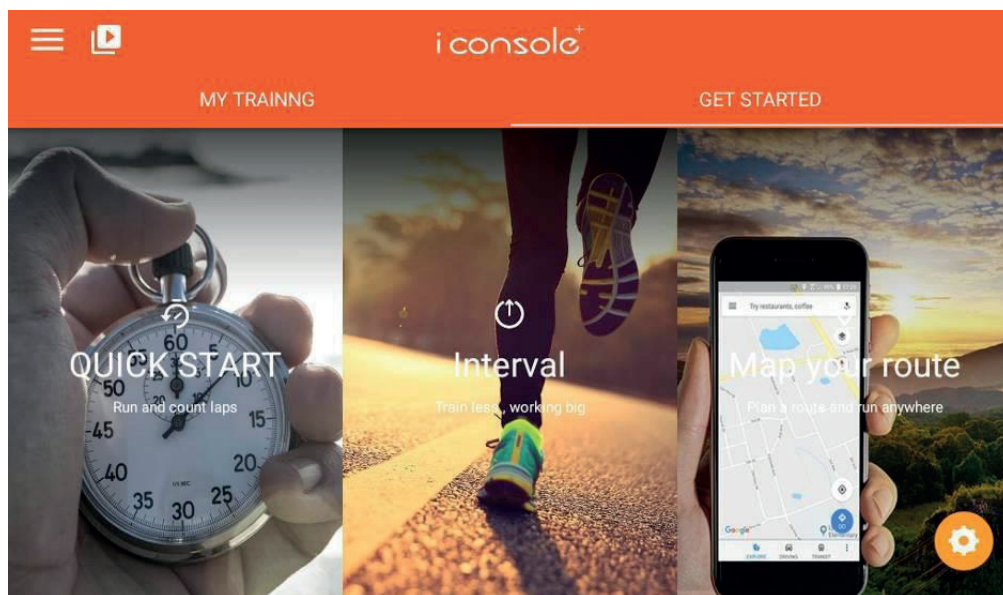

### 3.4.1 Quick-Start Programme/Target Programme

1. Tap QUICK START in the main menu.
2. Set the values for the desired distance, time and/or calories for your training.

**NOTICE**

You can set one or more parameters. The set values are counted down to 0, the others are counted up accordingly.

3. To start the training, tap START.

*You can manually adjust the resistance during the workout.*

4. To pause the training, tap PAUSE.
5. To stop the training, tap STOP.

→ *When the training is finished, a summary of the recorded training parameters is displayed.*

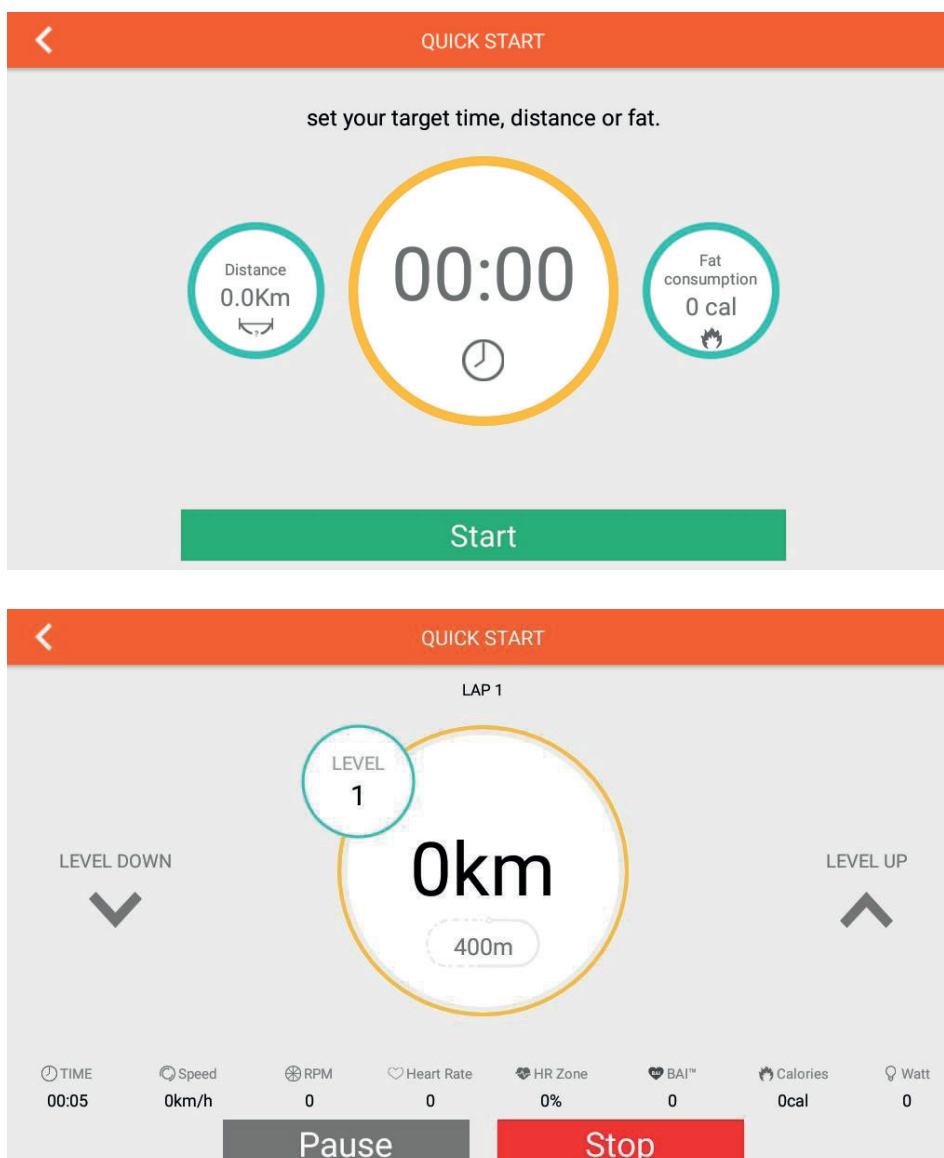

### 3.4.2 Pre-set Programmes

1. Tap PROGRAMS in the main menu.
2. Set the desired training time.
3. Select one of the 12 pre-set programmes.
4. To start the training, tap START.

*You can manually adjust the resistance during the training.*

5. To pause the training, tap PAUSE.
6. To stop the training, tap STOP.

→ *When the training is finished, a summary of the recorded training parameters is displayed.*

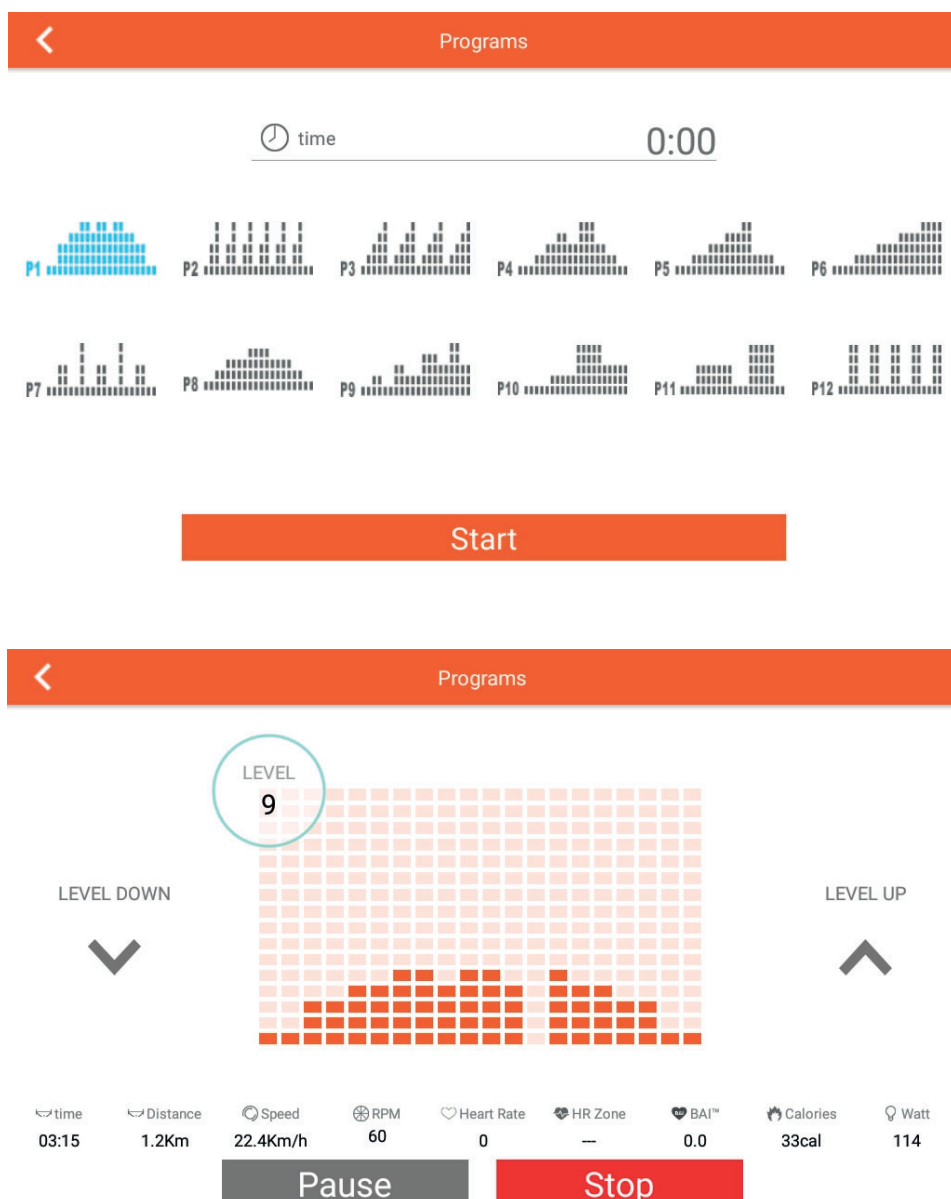

### 3.4.3 Interval Programme

1. Tap INTERVAL in the main menu.
2. Set the values for the desired number of cycles, time, resistance and revolutions per minute for your workout.
3. To start the training, tap START.

*The workout starts with a 1-minute warm-up.*

*You can manually adjust the resistance during the training.*

4. To pause the training, tap PAUSE.
5. To stop the training, tap STOP.

→ *When the training is finished, a summary of the recorded training parameters is displayed.*

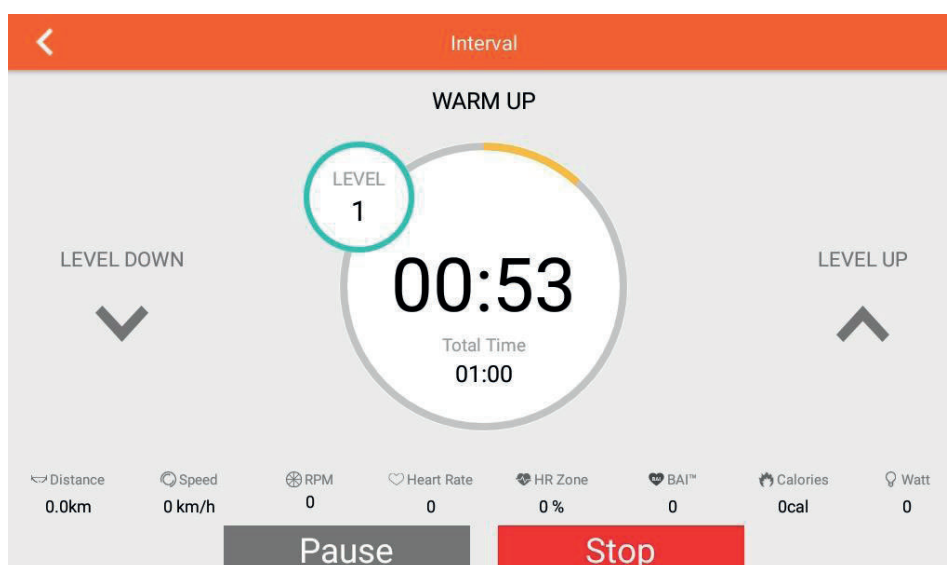
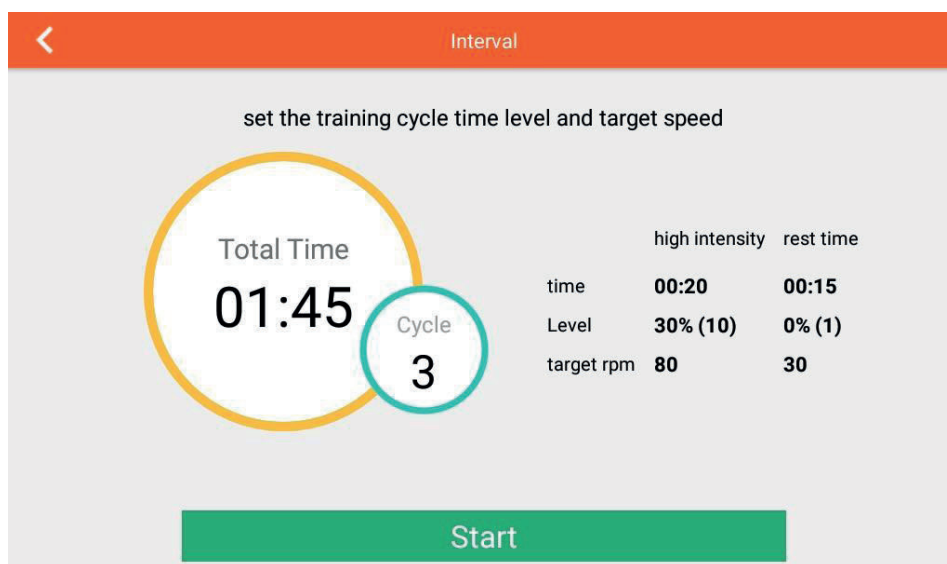

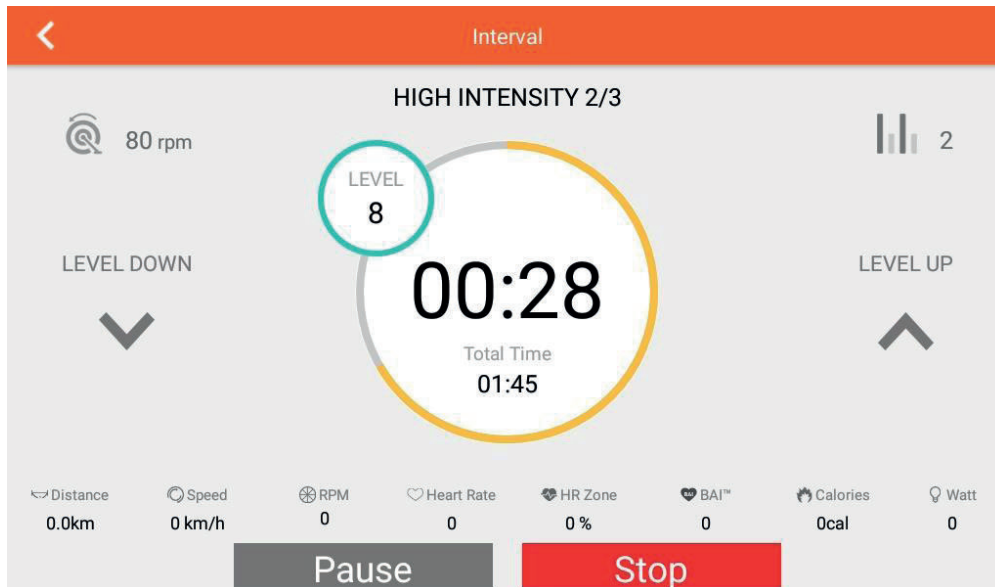

### 3.4.4 Heart Rate Controlled Programmes

#### WARNING

Your exercise equipment is not a medical device. The heart rate measurement of this device may be inaccurate. A variety of factors can affect the accuracy of the heart rate display. The heart rate display is intended only as a training aid.

#### NOTICE

For this programme, a chest strap is required.

You can choose between three preset heart rate programmes and one programme, where you individually set a pulse value (55 %, 75 %, 90 % of your max. pulse and TAG PULSE).

In the heart rate programmes, the resistance is automatically adjusted depending on your heart rate. Your maximum heart rate is determined by the console depending on your entered age.

1. Tap HEART RATE CONTROL in the main menu.
2. Enter your age and the desired training time.
3. Select either 55%, 75%, 90% or Target Pulse.
  - 3.1. If you selected Target Pulse, now set the desired pulse value.
4. To start the training, tap START.

*The resistance is adjusted according to your heart rate. The resistance cannot be adjusted manually.*

#### NOTICE

If the console does not receive a pulse signal for 30 seconds, the programme will automatically stop.

5. To pause the training, tap PAUSE.
6. To pause the training, tap STOP.

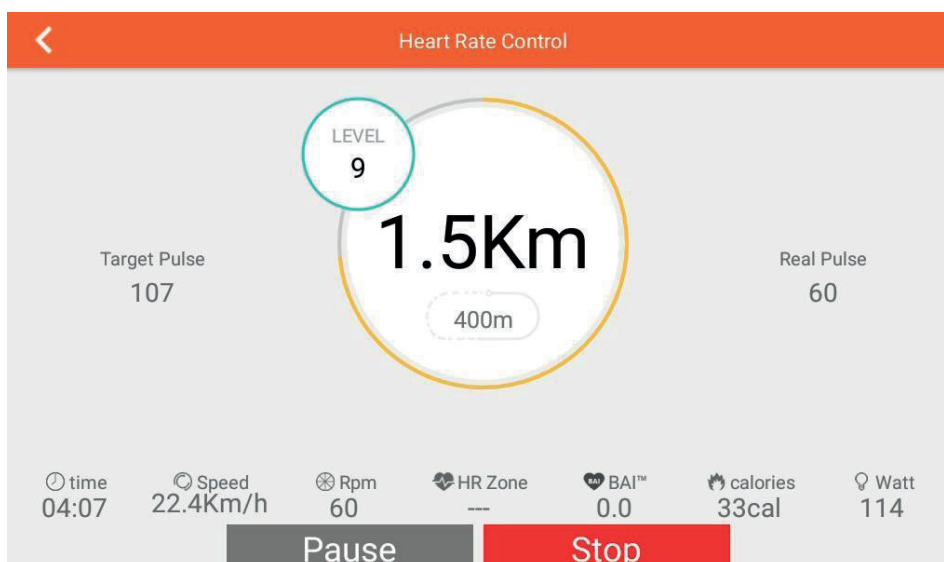
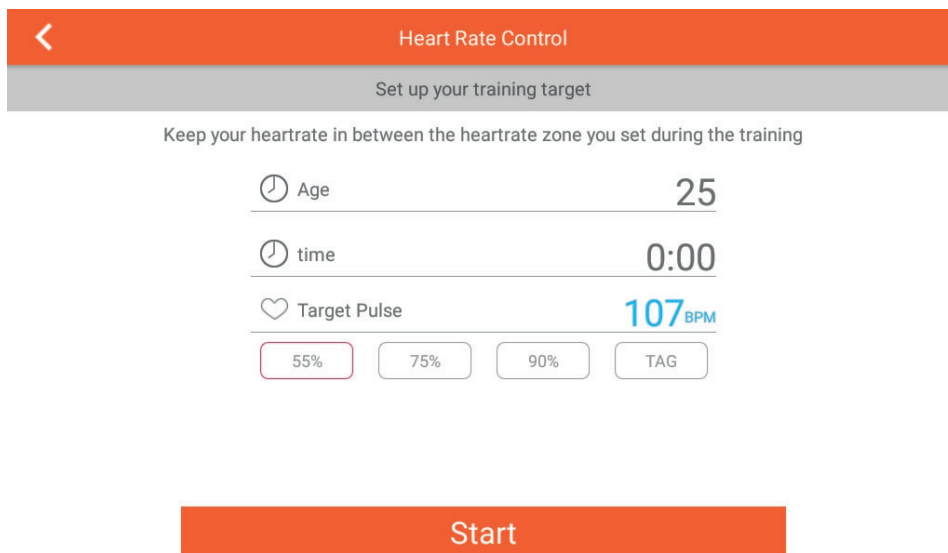

→ *When the training is finished, a summary of the recorded training parameters is displayed.*



### 3.4.5 Watt Programme

1. Tap CONSTANT POWER in the main menu.
2. Set the values for the desired training time, target wattage and target cadence for your training.
3. To start the training, tap START.

The resistance level is automatically adjusted according to the wattage you set.

4. To pause the training, tap the following icon .
5. To stop the training, tap the following icon .

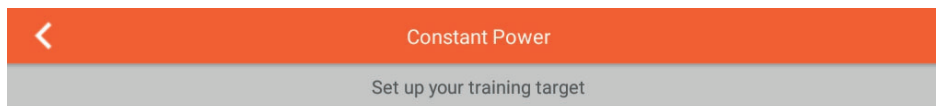

→ When the training is finished, a summary of the recorded training parameters is displayed.

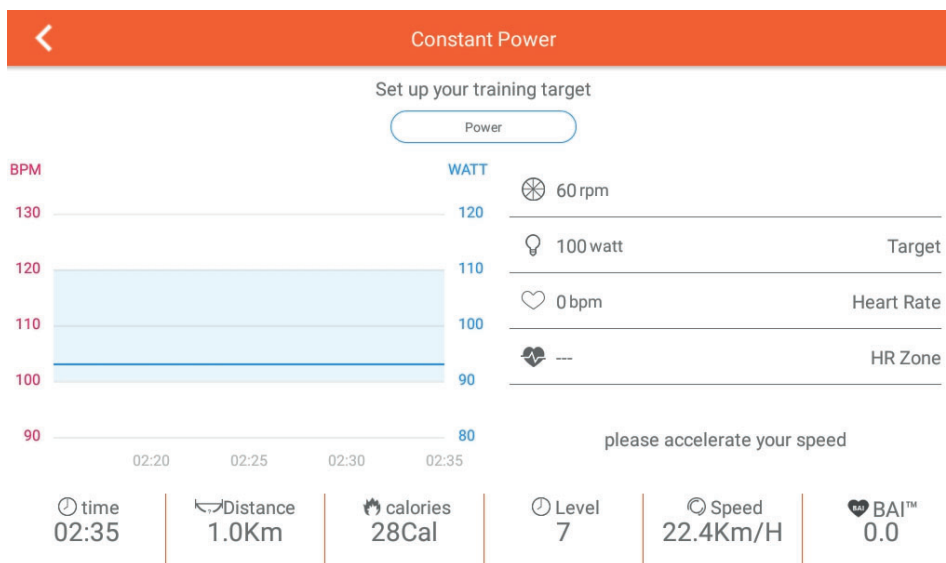

time 0:00  
Target Power 100WATT









### 3.4.6 Virtual Training Routes



1. Tap MAP YOUR ROUTE in the main menu.
2. After you have started this mode, you must determine your current position. To do this, tap the following icon .
3. To switch to the worldwide Google Maps view, tap the following icon .

**NOTICE**

If you are within China, you can also select the default region by tapping the following icon .

4. Select your start position and tap until the following icon appears .
5. Select your end position and tap it again until the following icon appears .
6. If desired, select one or more stopovers on your route and tap a third (or correspondingly more) time(s) until the following icon appears .
7. To cancel your selection, tap the following icon .
8. To start the training, swipe the following icon from left to right .
9. To show or hide the training parameters, tap the following icon .
10. To switch between the map view, Google Street View and the satellite view, tap the following icon .

*The resistance level is automatically adjusted according to the condition of the track. Alternatively, you can adjust the resistance level manually during the workout.*

11. To pause the training, tap the following icon .
12. To end the training, tap the following icon .

→ *When the training is finished, a summary of the recorded training parameters is displayed.*



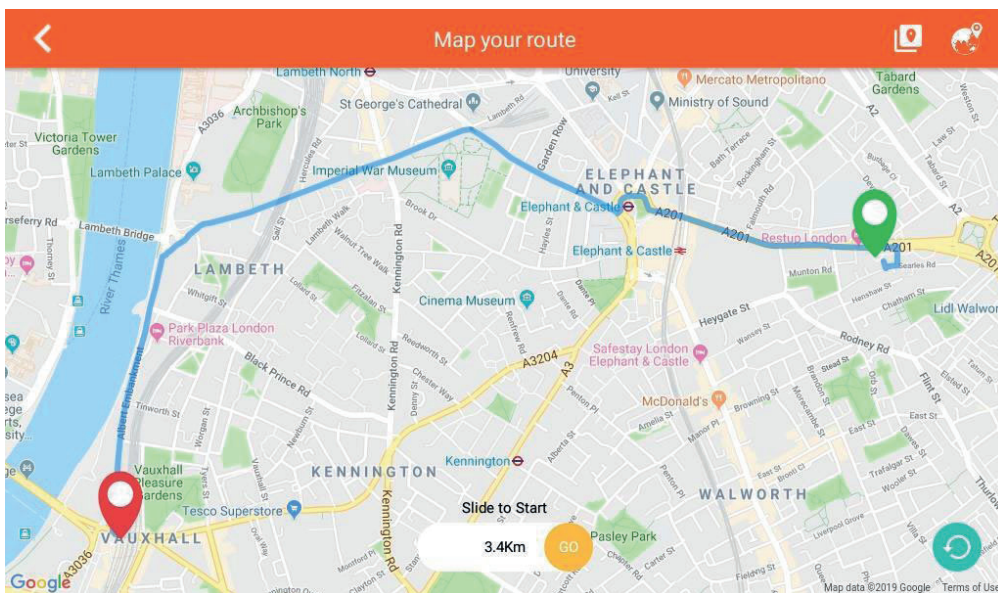
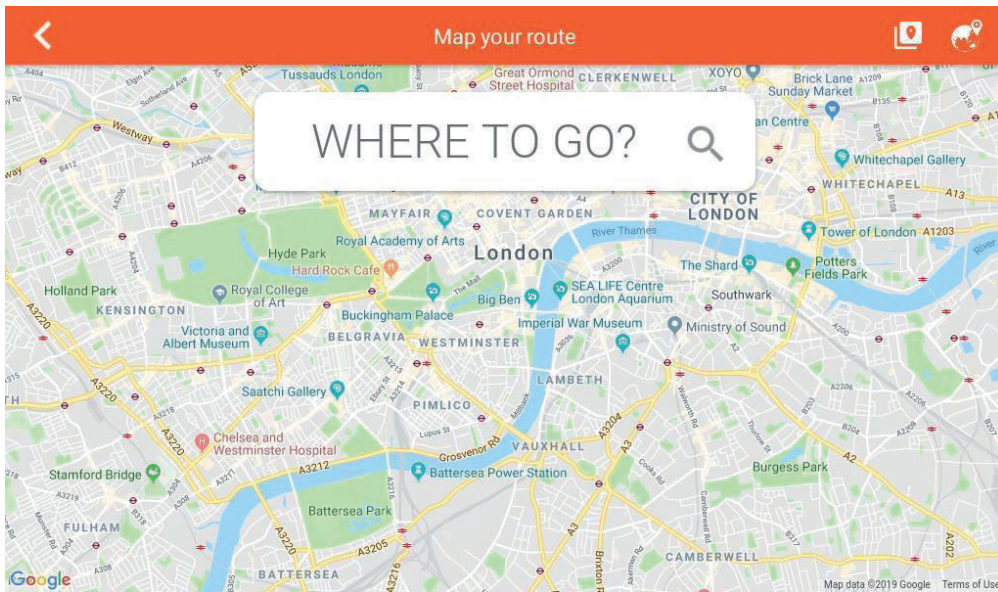

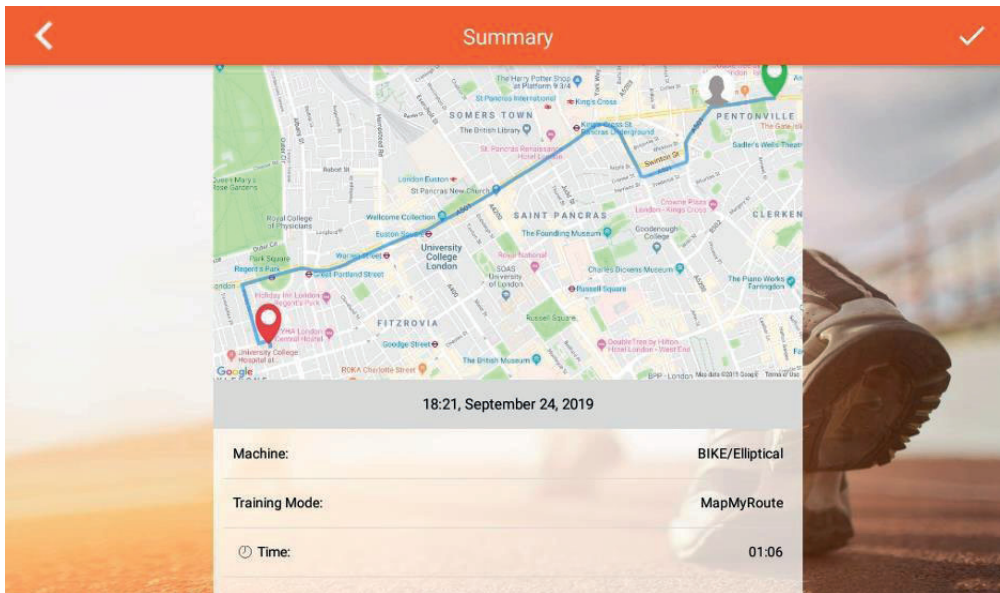
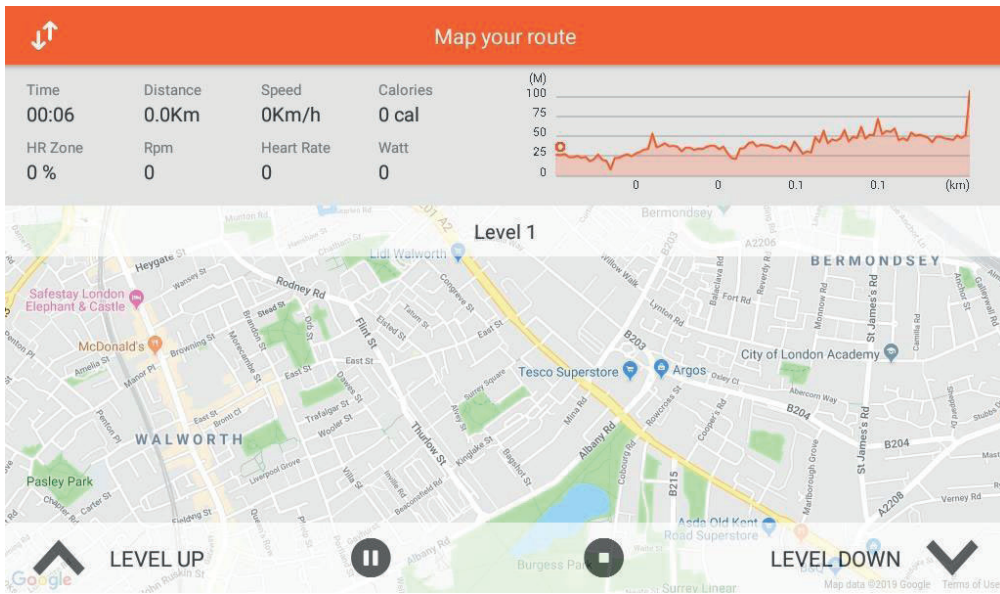

## 3.5 Multimedia and Software Updates

### ► ATTENTION

Check your TFT-console regularly for possible software updates. If available, make sure to carry out the updates soon. If the updates are not carried out over a longer period of time, this can lead to technical problems with the console.

To make sure the pre-installed apps are working correctly, they must be updated regularly as well. Follow the instructions on the screen to perform the updates.

Please note: The system is set up only for the pre-installed apps. Do not install any additional apps as their proper functionality can not be guaranteed. The installation of other apps might cause technical issues.

### ① NOTICE

- + The pre-installed apps are produced and provided by external manufacturers. Changes and availability within these apps might occur. Fitshop does not take any responsibility and can not be held liable for the availability, functionality or contents of these apps.

There are a variety of apps available to you. These include:

- + Netflix
- + Youtube
- + Spotify
- + Kinomap
- + Internet browser
- + Facebook
- + Twitter
- + Instagram
- + Amazon Prime Video
- + Amazon Shopping

You can access all of the above apps during training. You can show or hide the training parameters by tapping the following icon .

To return to the main menu, tap the following icon .

To go back one page within the apps, tap the following icon .

To start the training, tap the following icon .

To stop the training, tap the following icon .

### 3.6 Wireless Connection and Fitness Apps

This console is equipped with a wireless interface. Please take note that your mobile device needs to be compatible with the wireless interface of the treadmill.

To use training apps you will have to activate the wireless function on your mobile device (tablet or smart phone) and start the fitness app. Select your fitness equipment. Please follow the instructions given in the app. You will find the name of your fitness equipment on a small sticker on the back of the console.

You will find the fitness apps in the app stores of Google or Apple. There you will find the apps "Kinomap". Please note that these apps are produced by an external manufacturer. Fitshop does not take any responsibility regarding the availability, functionality or contents of these programmes.

#### IMPORTANT NOTE

The pre-installed apps are produced and provided by external manufacturers. Changes and availability within these apps might occur. Fitshop does not take any responsibility and can not be held liable for the availability, functionality or contents of these apps. To make sure the pre-installed apps are working correctly, they must be updated regularly. If needed, the respective app will notify you to do so. To update the app, you need a google account. A google email is sufficient. Just follow the instructions on the screen to perform the update.

Please note: The system is set up only for the pre-installed apps. Do not install any additional apps as their proper functionality can not be guaranteed. The installation of other apps might cause technical issues.

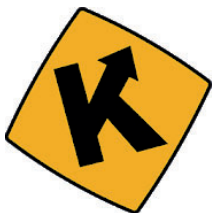
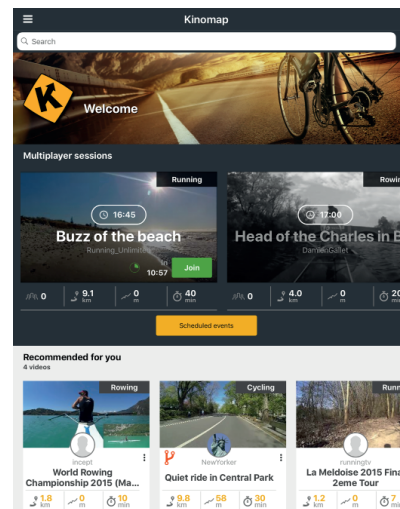
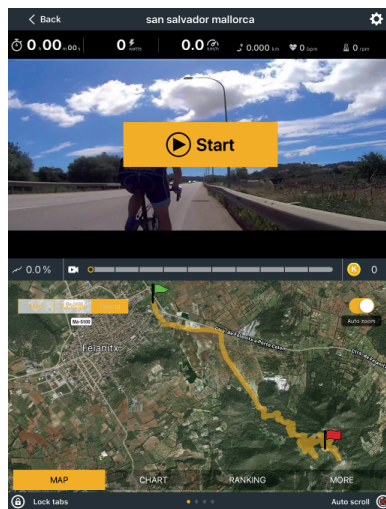
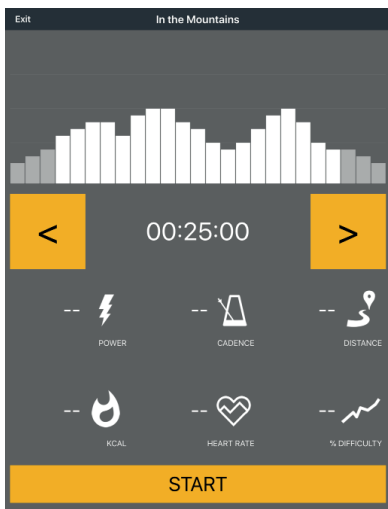

Example: Kinomap

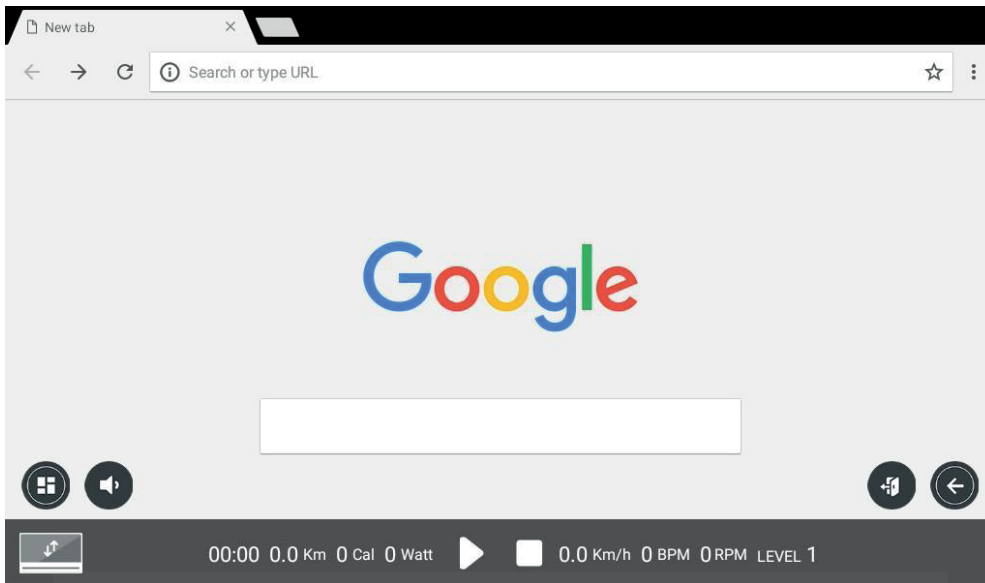

Example of an app



Overview of apps and possible software updates

## 4.1 General Instructions

► **ATTENTION**

- + Make sure that the equipment is protected from moisture, dust and dirt in the selected storage location. The storage location should be dry and well ventilated and have a constant ambient temperature between 5°C and 45°C.

⚠ **WARNING**

- + The storage location should be chosen so that improper use by third parties or children can be prevented.
- + If your equipment does not have transportation wheels, the equipment must be disassembled before transportation.

## 4.2 Transportation Wheels

► **ATTENTION**

If you want to transport your equipment over particularly sensitive and soft floor coverings, such as parquet, planks or laminate, lay out the transport route with cardboard or similar to avoid possible floor damage.

1. Stand behind the equipment and lift it until the weight is transferred to the transportation wheels. After that, you easily can move the equipment to a new position. For long transport distances the equipment should be disassembled and safely packed.
2. Select the new location by following the instructions in the section 1.4 of this manual.

## 5.1 General Instructions

⚠ **WARNING**

- + Do not make any improper changes to the equipment.

⚠ **CAUTION**

- + Damaged or worn components may affect your safety and the life of the equipment. Therefore, immediately replace damaged or worn components. In such a case, contact the contract partner. The equipment must not be used until it has been repaired. If necessary, use only original spare parts.

► **ATTENTION**

- + In addition to the instructions and recommendations for maintenance and care given here, additional service and/or repair work may be necessary; this must only be carried out by authorised service technicians.

## 5.2 Faults and Fault Diagnosis

The equipment undergoes regular quality controls during production. Nevertheless, faults or malfunctions may occur. Frequently, individual parts are responsible for these disturbances, an exchange is usually sufficient. Please refer to the following overview for the most common errors and how to correct them. If the equipment still does not function properly, contact your contract partner.

Fault	Cause	Solution
Cracking in the pedal area	Pedals loose	Tighten the pedals
Equipment wobbles	Equipment is not level	Align the feet
Handlebar/saddle wobbles	Loose screws	Tighten screws firmly
Display is blank/is not working	Batteries empty or loose cable connection	Replace batteries or check cable connections
No pulse display	<ul style="list-style-type: none"> <li>+ Sources of interference in the room</li> <li>+ unsuitable chest strap</li> <li>+ Wrong position of chest strap</li> <li>+ Chest strap defective or battery empty</li> <li>+ Pulse display defective</li> </ul>	<ul style="list-style-type: none"> <li>+ Eliminate sources of interference (e.g. mobile phone, WLAN, lawn mower and vacuum cleaner robot, etc. ...)</li> <li>+ Use a suitable chest strap (see "RECOMMENDED ACCESSORIES")</li> <li>+ Reposition chest strap and/or moisten electrodes</li> <li>+ Changing batteries</li> <li>+ Check if pulse display by hand pulse possible</li> </ul>

## 5.3 Error Codes and Troubleshooting

The electronics of the equipment continuously carries out tests. In case of deviations, an error code appears on the display and normal operation is stopped for your safety.

**Please contact the contract partner for technical support.**

## 5.4 Maintenance and Inspection Calendar

To avoid damage from body sweat, the equipment must be cleaned with a damp towel (no solvents!) after each training session.

The following routine tasks must be performed at the specified intervals:

Part	Weekly	Monthly
Display console	C	I
Plastic covers	C	I
Screws and cable connections		I
Check pedals for tightness		I
Legend: C = clean; I = inspect		

By scanning the QR-code with the camera function or QR-code scanner app of your smartphone/tablet, a video on general maintenance of an exercise bike opens on YouTube. The video serves to illustrate the maintenance points described in this manual.

Please note that the video may not be available in your language or with appropriate subtitles.

If you cannot scan QR-codes, you can access all Fitshop videos on YouTube by first opening YouTube and entering "Fitshop" in the search field.



## 6 DISPOSAL

At the end of its operational life, this equipment cannot be disposed of in normal household waste. Instead, it must be disposed of via an electricals recycling centre. Further information can be obtained from your local authority's recycling service.



The materials can be recycled as per their symbols. Through the reuse, recycling of materials or other forms of recovery of old equipment, you make an important contribution to the protection of the environment.



## 7 RECOMMENDED ACCESSORIES

To make your training experience even more efficient and pleasant, we recommend that you add suiting accessories to your fitness equipment. For exercise bikes this could for example be a **floor mat**, which makes your fitness equipment stand more securely and also protects the floor from sweat or **silicone spray** to keep moving parts in good shape. For many exercise bikes it is possible to replace the **saddle** or **pedals**, as these are usually the same mounts used on bicycles.

If you have purchased a fitness machine with pulse training and want to train your heart rate, we strongly recommend that you use a compatible **chest strap**, as this ensures optimum transmission of the heart rate.

Our range of accessories offers the highest quality and makes training even better. If you would like to find out more about compatible accessories, please go to the detail page of the product in our webshop (the easiest way is to enter the article number in the search field above) and go to the recommended accessories on this page. Alternatively, you can use the QR-code provided. Of course, you can also contact our customer service: by telephone, e-mail, in one of our branches or via our social media channels. We will be happy to advise you!

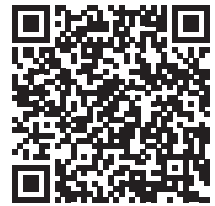

chest strap



floor mat



lubricant

## 8.1 Serial Number and Model Name

In order to provide you with the best possible service, please have the model name, article number, serial number, exploded drawing and parts list ready. The corresponding contact options can be found in chapter 10 of this operating manual.

**NOTICE**

The serial number of your equipment is unique. It's located on a white sticker. The exact position of this sticker is shown in the following illustration.

Enter the serial number in the appropriate field.



**Serial number:**

**Brand / Category:**

**Model Name:**

**SKU:**

## 8.2 Parts List

No.	Qty.	Name	Supplier Parts No.	Specification
1	1	Main frame	81555-3-1000-J1	
2	1	Rear stabilizer	70950-6-2107-J3	95.4*50.6*2.0Tx500L
3	4	Adjustable wheel	76100-6-2174-B0	D50*M10*1.5
4	1	Front stabilizer	83250-3-2100-J1	
5	2	Tri-angle cap(left)	55357-B-5095-B8	95.7*57.2*51.3
6	2	Tri-angle cap(right)	55357-A-5095-B8	95.7*57.2*51.3
7	4	Flat washer D16*D8.5*1.2T	55108-1-1612-FA	D16*D8.5*1.2T
8	4	Spring washer D15.4 XD8.2x2T	55108-2-1520-FA	D15.4 XD8.2x2T
9	12	Allen bolt M8x1.25x20L	25600-6-3191-F0	M8x1.25x20L
10	1	Seat LS-A28	58001-6-1369-BA0	A28,clamp
11	1	Seat adjustment tube	84802-3-4000-J3	
12	2	Handle pulse fixing bracket / upper	737L6-6-2491-B0	
13	2	Handle pulse fixing bracket / lower	737L6-6-2492-B0	
14	2	Square cap	55318-2-3838-B8	38x38x18L
15	1	quick-released knob	52712-2-0025-BA	M12*25L
16	2	round cross screw	50805-2-0010-N0	M5*0.8*10L
17	1	Computer	81555-6-2501-B0	SV-8635-78
18	2	C-clip D22.5*D18.5*1.2T	55519-1-2312-DA	D22.5*D18.5*1.2T
19	1	Rear cover	81502-6-2430-BZ0	
20	2	Bolt M5x0.8x15L	50805-2-0015-F0	M5x0.8x15L
21	1	Belt	58004-6-1125-00	995 J6
22	1	Waved washer D27*D20.3*0.5T	55120-5-2705-DA	D27*D20.3*0.5T
23	2	Cover for wheel	83250-6-2176-B0	93.2*64.7*62
24	1	Pulley	58008-6-1040-00	D260*19*2T
25	4	Bolt M6x1.0x15L	50106-5-0015-C0	M6x1.0x15L
26	4	Nylon nut M6x1.0x6T	55206-1-2006-CA	M6x1.0x6T
27	1	Crank axle	81750-3-2903-00	
28	1	Upper protective cover	81800-6-4580-BZ0	
29	1	Handlebar post	81555-3-2000-J0	
30	4	Allen bolt M8*1.25*50L	50308-5-0050-UF3	M8*1.25*50L,

31	1	bolt cover	18600-6-2171-B0	D29*21(M8)
32	1	Fixed handlebar	81555-3-2400-B0	
33	2	Screw cover D26*11L	81502-6-2779-B0	
34	2	Anti-loosen nut M10*1.25*10T	70501-6-2775-N0	
35L	1	Left crank	58007-6-1082-D0	
35R	1	right crank	58007-6-1081-D0	
36	1	Left chain cover	81502-6-4501-BZ0	
37	1	Right chain cover	81502-6-4502-BZ0	
38	1	Bolt M5*0.8*10L	54805-2-0010-N0	M5*0.8*10L
39	1	Fixing Plate	815G0-6-1673-N0	20*27*4T
40	1	Round cycle for chain cover	81502-6-4503-B0	117*58*9.3
41	1	EMS system	81555-2-3100-00	
42	1	Allen bolt M8x1.25x50L	50308-5-0050-C0	M8x1.25x50L
43	2	Protective strip	81555-6-2278-B0	50*10*3T
44	2	Buffer strip	81555-6-2089-B0	85*15*2T
45	4	Bolt M6*1.0P*16L	815S1-6-3191-F0	M6*1.0P*16L
46	8	Bolt M5*0.8*15L	52605-5-0015-F0	M5*0.8*15L
47	1	Water bottle holder	186N3-6-2074-J1	
48	2	Screw ST4x1.41x15L	50904-2-0015-F0	ST4x1.41x15L
49	1	Flat washer D24*D16*1.5T	55116-1-2415-NA	D24*D16*1.5T
50	1	computer fixing plate	81555-6-2402-J0	327*180*2.5T
51	1	idle wheel axle	731S1-6-1602-01	D19*27.5L
52	2	Nylon nut M8*1.25*8T	55208-1-2008-NA	M8*1.25*8T
53	2	Nut M8*1.25*6T	55208-2-2006-NA	M8*1.25*6T
54	1	Fixing plate for idle wheel	742G0-6-1601-N1	125.3*5T
55	2	Plastic cover	803K0-6-1082-00	
56	1	Spring D1.8*D14*70L	58003-6-1080-N0	D1.8*D14*70L
57	3	Plastic washer D10*D24*0.4T	55110-1-2404-BF	D10*D24*0.4T
58	1	Flat washer D28*D8.5*3T	55108-1-2830-NA	D28*D8.5*3T
59	2	Bearing #99502	58006-6-1016-00	#99502
60	1	Bolt M8*1.25*16L	51608-5-0016-F0	M8*1.25*16L
61	2	ground wire	734S0-6-3486-00	200L
62L	1	Left pedal	58029-6-1105-B0	JD-36A
62R	1	right pedal	58029-6-1105-B0	

63	1	electric transport cable	815S5-6-2552-00	1500L
65	1	Protective cover	81000-6-2481-B0	100*81*40.8
66	1	Seat post	815S1-3-2200-C1	
67	4	Hand pulse	737L6-6-2478-00	100.3*29.5*0.4T
68	2	Handle pulse cable	745S1-6-2479-00	900L
69	1	Round magnet	174R4-6-2574-00	
70	2	Bearing	58006-6-1040-01	
71	1	Connecting cable	738G0-6-3177-00	500L
72	1	Upper computer cable	801S0-6-2572-01	1000L
73	1	Lower computer cable	815S0-6-2573-00	1800L
74	1	Sensor cable	821S0-6-2576-00	250L
75	1	Knob	52916-2-0022-G1	D50xM16x22xD8
76	1	Inner tube	195E5-6-1071-B0	
77	4	bushing	58002-6-1099-00	D22.2*D8.2*7T
78	2	Round wheel	84302-6-2175-00	D70.5*23
79	3	Bolt ST4*1.41.13L,D10	54704-2-0013-F0	ST4*1.41.13L,D10
80	2	Allen bolt M8*1.25*40L	50308-5-0040-F3	M8*1.25*40L
81	1	Electric Cable	26100-6-1775-02	1700L
82	1	Controller	815S5-6-2597-01	EMS-7600
83	2	Screw ST4*1.41*10L	51004-2-0010-F0	ST4*1.41*10L
84	13	Screw ST4.2x1.4x20L	53342-2-0020-N0	ST4.2x1.4x20L
85	2	Nylon nut M8*1.25*8T	55208-1-2008-FA	M8*1.25*8T
86	3	Pin	71600-6-4586-60	D6*26.5*7.7
87	4	Screw ST4*1.41*12L	52804-2-0012-F0	ST4*1.41*12L
90	1	front left decorative cover	81502-6-4514-BZ0	
91	1	front right decorative cover	81502-6-4515-BZ0	
92	2	screw ST4.2*15L	52842-2-0015-F0	ST4.2*15L
93	1	Power supply	261D8-6-2411-00	
94	1	Power supply socket	26100-6-2413-00	
95	1	Live line	734S0-6-3480-00	150L
96	1	Netural line	734S0-6-3479-00	150L
/	1	Allen spanner	58030-6-1031-N1	
/	1	Spanner	58030-6-1035-N1	155*30*5T

# 8.3 Exploded Drawing

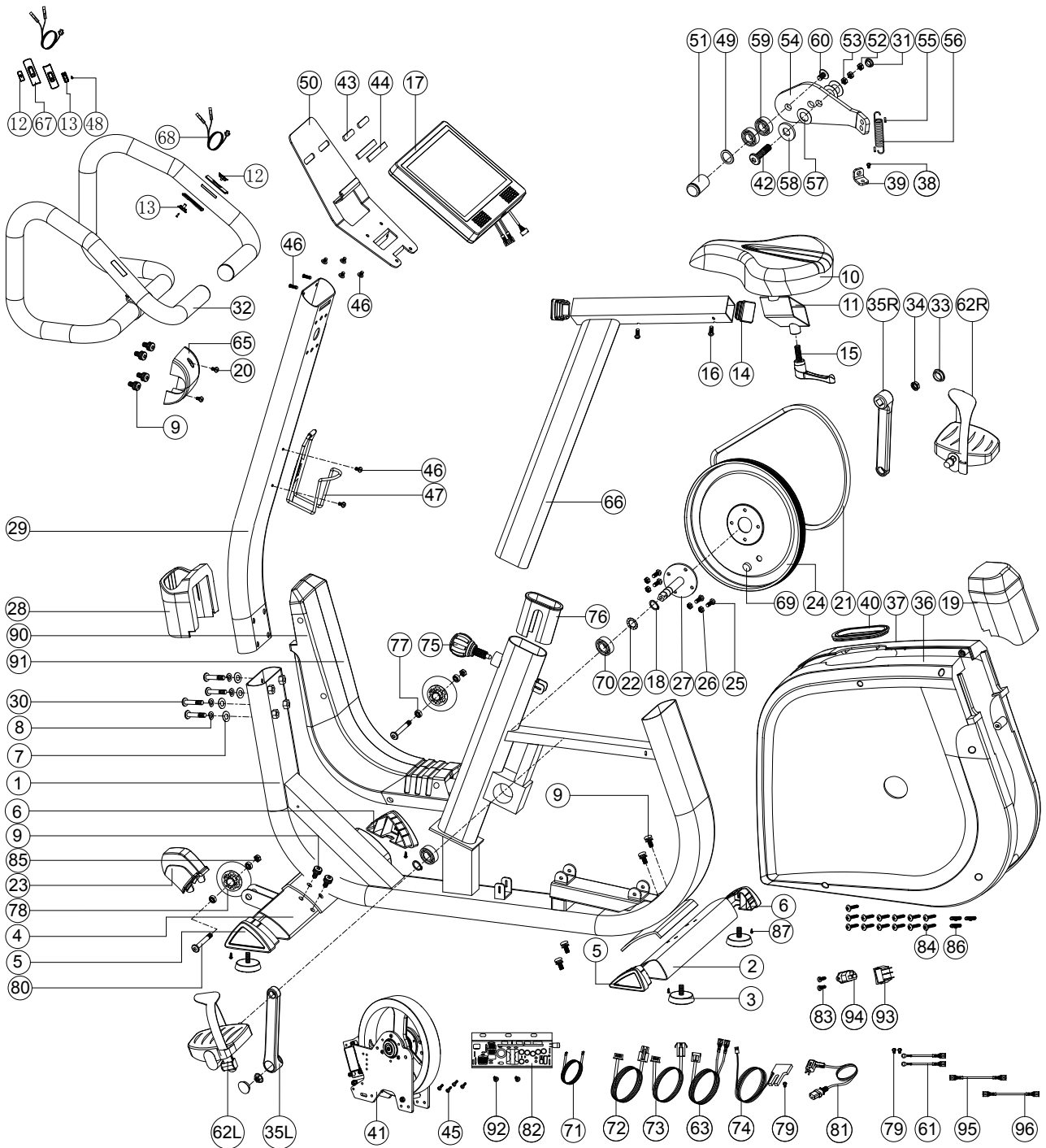

Products from cardiostrong® are subject to strict quality control. However, if a fitness equipment purchased from us does not work perfectly, we take it very seriously and ask you to contact our customer service as indicated. We are happy to help you by phone via our service hotline.

### **Error Descriptions**

Your fitness equipment is developed for long-term, high-quality training. However, should a problem arise, please first read the operating instructions. For further assistance, please contact your contract partner or call our service hotline. To ensure your problem is solved as quickly as possible, please describe the defect as exactly as possible.

In addition to the statutory warranty, we provide a warranty for every fitness equipment purchased from us according to the following provisions.

**Your statutory rights are not affected.**

### **Warranty**

The warranty is the first/original buyer.

### **Warranty periods**

The following warranty periods begin on delivery of the fitness equipment.

#### **Warranty period**

The warranty periods, shown on our web shop, begin on delivery of the fitness equipment. The respective warranty periods for your equipment can be found on its product website.

### **Repair Costs**

According to our choice, there will either be a repair, a replacement of individual damaged parts or a complete replacement. Spare parts, that have to be mounted while assembling the equipment, have to be replaced by the warranty holder personally and are not a part of repair. After the expiration of the warranty period, the responsibility for parts costs, repair costs, installation costs and delivery costs lies with the warranty holder.

### **The terms of use are defined as follows:**

- + Home use: solely for private use in private households up to 3 hours per day
- + Semi-professional use: up to 6 hours per day (e. g. rehabilitation centres, hotels, clubs, company gyms)
- + Professional use: more than 6 hours per day (e. g. commercial gyms)

## Warranty Service

Within the warranty period, equipment which develops faults as a result of material or manufacturing defects, will be repaired or replaced at our discretion. Ownership of equipment or parts of equipment which have been replaced is transferred to us. The warranty period is not extended nor does a new warranty period begin following repair or replacement under the warranty.

## Warranty Conditions

For the warranty to be valid, the following steps must be taken:

Please contact our customer service by email or phone. If the product under warranty has to be sent in for repair, the seller bears costs. After expiry of the warranty, the buyer bears the costs of transport and insurance. If the fault is covered by our warranty, you will receive a new or repaired equipment in return.

## Warranty claims are invalid in case of damage resulting from:

- + misuse or improper handling
- + environmental influences (moisture, heat, electrical surge, dust, etc.)
- + failure to follow the current safety measures for the equipment
- + failure to follow the operating instructions
- + use of force (e. g. hitting, kicking, falling)
- + interventions which were not carried out by one of our authorized service centres
- + unauthorised repair attempts

## Proof of Purchase and Serial Number

Please make sure that you are able to provide the appropriate receipt when claiming on your warranty. So that we can clearly identify the model of your equipment, and for the purposes of our quality control, you will need to give the serial number of your equipment, when contacting the service team. Where possible please have your serial number and your customer number ready when you call our service hotline. It will help us to deal with your request swiftly.

If you cannot find the serial number on your fitness equipment, our service team is at your disposal to offer further information.

## Service outside of the Warranty Period







































We are also happy to issue an individual cost estimate if there is a problem with your fitness equipment after the warranty has expired, or in cases which do not fall under the terms of the warranty, e. g. normal wear and tear. Please contact our customer service team to find a quick and cost-effective solution to your problem. In such a case you will be responsible for the delivery costs.

## Communication

Many problems can be solved just by speaking to us as your specialist supplier. We know how important it is to you as a user of the fitness equipment to have problems solved quickly and simply, so you can enjoy working out with minimal interruption. For that reason, we also want to resolve your queries quickly and in a straightforward manner. Thus, please always keep your customer number and the serial number of the faulty equipment handy.



## 10 CONTACT

DE	DK	UK
<p><b>TECHNIK</b></p> <p> +49 4621 4210-900</p> <p> +49 4621 4210-698</p> <p> <a href="mailto:technik@fitshop.de">technik@fitshop.de</a></p> <p> Öffnungszeiten entnehmen Sie unserer Homepage.</p>	<p><b>TEKNIK OG SERVICE</b></p> <p> 80 90 16 50</p> <p>+49 4621 4210-945</p> <p> <a href="mailto:info@fitshop.dk">info@fitshop.dk</a></p> <p> Åbningstider kan findes på hjemmesiden: <a href="https://stg.fit/statit7">https://stg.fit/statit7</a></p>	<p><b>CUSTOMER CARE</b></p> <p> +44 141 737 2249 or +44 141 876 3972</p> <p> <a href="mailto:customercare@fitshop.co.uk">customercare@fitshop.co.uk</a></p> <p> You can find the opening hours on our homepage: <a href="https://stg.fit/statitd">https://stg.fit/statitd</a></p>
<p><b>SERVICE</b></p> <p> 0800 20 20277 (kostenlos)</p> <p> 04621 4210 - 0</p> <p> <a href="mailto:info@fitshop.de">info@fitshop.de</a></p> <p> Öffnungszeiten entnehmen Sie unserer Homepage: <a href="https://stg.fit/statita">https://stg.fit/statita</a></p>	<p><b>FR</b></p> <p><b>TECHNIQUE &amp; SERVICE</b></p> <p> +33 (0) 189 530984</p> <p>+49 4621 42 10 933</p> <p> <a href="mailto:info@fitshop.fr">info@fitshop.fr</a></p> <p> Vous trouverez les heures d'ouverture sur notre site Internet: <a href="https://stg.fit/statit4">https://stg.fit/statit4</a></p>	<p><b>BE</b></p> <p><b>TECHNIQUE &amp; SERVICE</b></p> <p> 02 732 46 77</p> <p>+49 4621 4210 933</p> <p> <a href="mailto:info@fitshop.be">info@fitshop.be</a></p> <p> Vous trouverez les heures d'ouverture sur notre site Internet: <a href="https://stg.fit/statit8">https://stg.fit/statit8</a></p>
<p><b>ES</b></p> <p><b>TECNOLOGÍA Y SERVICIOS</b></p> <p> 911 238 029</p> <p> <a href="mailto:info@fitshop.es">info@fitshop.es</a></p> <p> Consulta nuestro horario de apertura en la página web: <a href="https://stg.fit/statit5">https://stg.fit/statit5</a></p>	<p><b>NL</b></p> <p><b>TECHNISCHE DIENST &amp; SERVICE</b></p> <p> +31 172 619961</p> <p> <a href="mailto:service@fitshop.nl">service@fitshop.nl</a></p> <p> De openingstijden vindt u op onze homepage: <a href="https://stg.fit/statit3">https://stg.fit/statit3</a></p>	<p><b>INT</b></p> <p><b>TECHNICAL SUPPORT &amp; SERVICE</b></p> <p> +49 4621 4210-944</p> <p> <a href="mailto:service-int@fitshop.de">service-int@fitshop.de</a></p> <p> You can find the opening hours on our homepage: <a href="https://stg.fit/statita">https://stg.fit/statita</a></p>
<p><b>PL</b></p> <p><b>DZIAŁ TECHNICZNY I SERWIS</b></p> <p> 22 307 43 21</p> <p>+49 4621 42 10-948</p> <p> <a href="mailto:info@fitshop.pl">info@fitshop.pl</a></p> <p> Godziny otwarcia można znaleźć na stronie głównej: <a href="https://stg.fit/statit6">https://stg.fit/statit6</a></p>	<p><b>AT</b></p> <p><b>TECHNIK &amp; SERVICE</b></p> <p> 0800 20 20277 (Freecall)</p> <p>+49 4621 42 10-0</p> <p> <a href="mailto:info@fitshop.at">info@fitshop.at</a></p> <p> Öffnungszeiten entnehmen Sie unserer Homepage: <a href="https://stg.fit/statitb">https://stg.fit/statitb</a></p>	<p><b>CH</b></p> <p><b>TECHNIK &amp; SERVICE</b></p> <p> 0800 202 027</p> <p>+49 4621 42 10-0</p> <p> <a href="mailto:info@fitshop.ch">info@fitshop.ch</a></p> <p> Öffnungszeiten entnehmen Sie unserer Homepage: <a href="https://stg.fit/statit9">https://stg.fit/statit9</a></p>

Please find a detailed overview including address and opening hours for all stores of Fitshop UK on the following website:

[www.fitshop.co.uk/storelocator](http://www.fitshop.co.uk/storelocator)

# WE LIVE FITNESS

## WEBSHOP AND SOCIAL MEDIA

The Fitshop Group is Europe's largest specialist for home fitness equipment with currently 70 stores and one of the world's most renowned online mail order companies for fitness equipment.

Fitshop UK is part of the Fitshop Group. Private customers order via the 25 web shops in the respective national language or have their desired equipment assembled on site. In addition, the company supplies fitness studios, hotels, sports clubs, companies and physio practices with professional equipment for endurance and strength training.

The Fitshop group offers a wide range of fitness equipment from renowned manufacturers, high-quality in-house developments and comprehensive services, such as a build-up service and sports scientific advice before and after the purchase. The company employs numerous sports scientists, fitness trainers and competitive athletes.

Visit us also on our social media platforms or our blog!

	<a href="https://www.fitshop.co.uk">https://www.fitshop.co.uk</a> <a href="http://www.fitshop.co.uk/blog">www.fitshop.co.uk/blog</a>
	<a href="http://www.facebook.com/fitshop.co.uk">www.facebook.com/fitshop.co.uk</a>
	<a href="http://www.instagram.com/fitshop_uk">www.instagram.com/fitshop_uk</a>
	<a href="http://www.youtube.com/@fitshop_uk">www.youtube.com/@fitshop_uk</a>

**TAURUS**

 cardiostrong

*BODYCRAFT*

**BodyMax**





Exercise Bike **BX70i Touch**